









łącznik równoległy z zaciskiem przyłączeniowym, 4-bieg. 3RT231 z przyłączem śrubowym

Nazwa markowa produktu	SIRIUS		
kategoria produktu	Moduły okablowania, złączki i zestawy montażowe		
oznaczenie produktu	Łącznik równoległy		
wykonanie produktu	Łącznik równoległy do styczników S00		
oznaczenie typu produktu	3RT19		
Ogólne dane techniczne			
Wielkość stycznika	S00		
Dyrektywa RoHS (dzień/miesiąc/rok)	07/01/2006		
Waga netto na jedn.	0,018 g		
liczba biegunów	4		
Instalacja/ Mocowanie/ Wymiary			
rodzaj montażu	mocowanie śrubowe		
Zezwolenia Certyfikaty			
Environment	General Product Approval	EMV	Test Certificates
Environmental Confirmations		 EG-Konf.	
		 RCM	Special Test Certificate
Maritime application		other	
 ABS	 DNV	 PRS	 RINA
		Miscellaneous	Confirmation
other		Railway	
Miscellaneous		Special Test Certificate	

Więcej informacji

Informacje dotyczące opakowania

[Informacje dotyczące opakowania](#)

Information for data generation and storage

<https://support.industry.siemens.com/cs/ww/en/view/109995012>

Information- and Downloadcenter

<https://www.siemens.com/ic10>

Industry Mall (System zamawiania online)

<https://mall.industry.siemens.com/mall/pl/pl/Catalog/product?mlfb=3RT1916-4BB41>

CAX-Online-Generator

<https://support.automation.siemens.com/WW/CAXorder/default.aspx?lang=en&mlfb=3RT1916-4BB41>

Service&Support

<https://support.industry.siemens.com/cs/ww/en/ps/3RT1916-4BB41>

Image database (product images, 2D dimension drawings, 3D models, device circuit diagrams, EPLAN macros, ...)

https://www.automation.siemens.com/bilddb/cax_de.aspx?mlfb=3RT1916-4BB41&lang=en

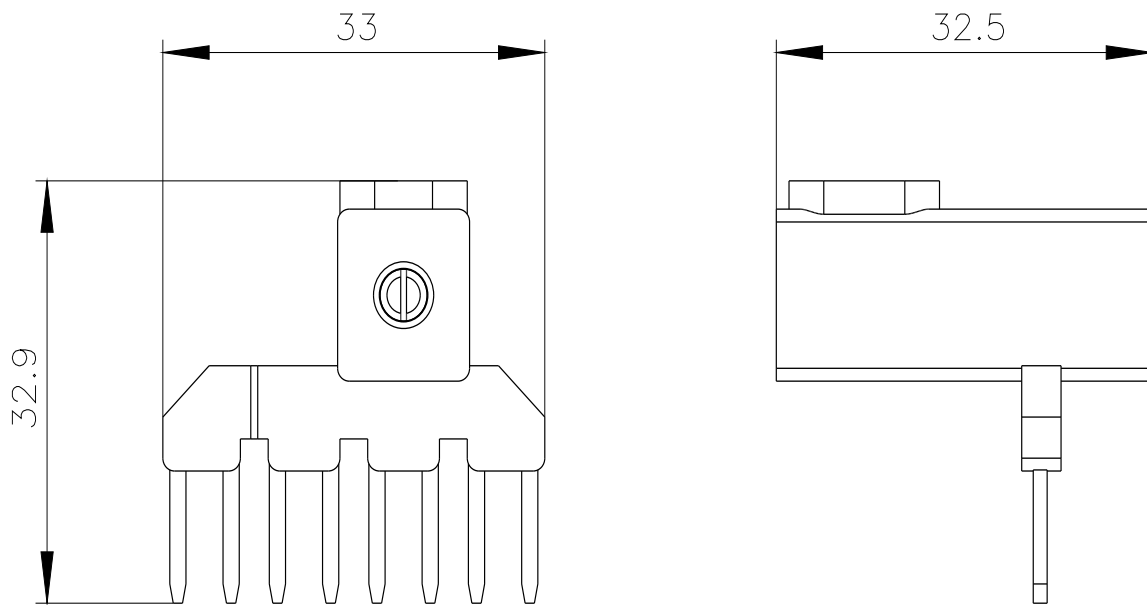

Ostatnia zmiana:

2.04.2025 