

moduł do blokady z dźwignią przechylną i ciągnem Bowdena akcesorium do:
3VA12



Wersja	
Nazwa markowa produktu	SETRON
oznaczenie produktu	moduł
akcesoria	moduł do
Ogólne dane techniczne	
Waga netto na jedn.	203 g
Certyfikaty	
General Product Approval	EMV

[Miscellaneous](#)



[Confirmation](#)



Test Certificates	Maritime application	other	Environment		
Type Test Certificates/Test Report		Miscellaneous	Confirmation	Environmental Confirmations	Environmental Confirmations

Więcej informacji

Informacje dotyczące opakowania

[Informacje dotyczące opakowania](#)

Information for data generation and storage

<https://support.industry.siemens.com/cs/ww/en/view/109995012>

Information- and Downloadcenter (Catalogs, Brochures,...)

<https://www.siemens.com/lowvoltage/catalogs>

Industry Mall (Online ordering system)

<https://mall.industry.siemens.com/mall/en/en/Catalog/product?mlfb=3VA9257-0VF10>

Service&Support (Manuals, Certificates, Characteristics, FAQs,...)

<https://support.industry.siemens.com/cs/ww/pl/ps/3VA9257-0VF10>

Image database (product images, 2D dimension drawings, 3D models, device circuit diagrams, ...)

https://www.automation.siemens.com/bilddb/cax_en.aspx?mlfb=3VA9257-0VF10

CAX-Online-Generator

<https://www.siemens.com/cax>

Tender specifications

<https://www.siemens.com/specifications>

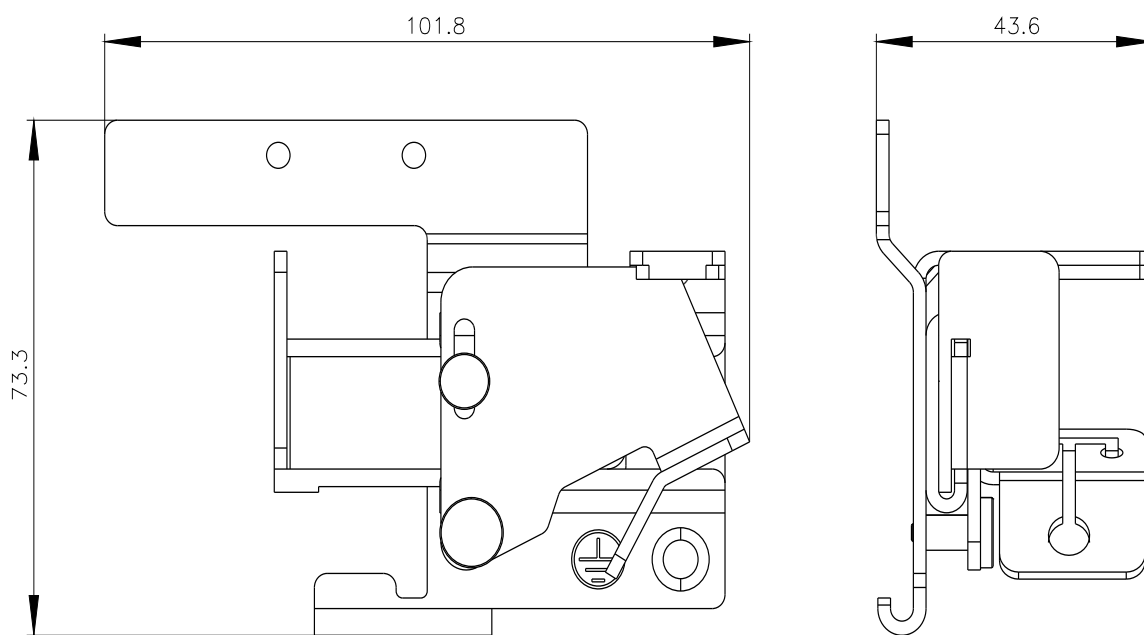

Ostatnia zmiana:

3.04.2025 

