

- Industrial design
- Width 22.5mm
- 8 functions
- 8 time ranges
- 1 change over contact



► Technical design

► 1. Functions

E	ON delay
R	OFF delay with control contact
Ws	Single shot leading edge with control contact
Wa	Single shot trailing edge with control contact
Es	ON delay with control contact
Wu	Single shot leading edge voltage controlled
Bp	Flasher pause first
Wt	Pulse detection

► 2. Time ranges

Time range	Adjustment range	
1s	50ms	1s
10s	500ms	10s
1min	3s	1min
10min	30s	10min
1h	3min	1h
10h	30min	10h
1d	72min	1d
10d	12h	10d

► 3. Indicators

Green LED ON:	indication of supply voltage
Green LED flashes:	indication of time period
Yellow LED ON/OFF:	indication of relay output

► 4. Mechanical design

Self-extinguishing plastic housing, IP rating IP40
 Mounted on DIN-Rail TS 35 according to EN 50022
 Mounting position: any
 Shockproof terminal connection according to VBG 4 (PZ1 required), IP rating IP20
 Initial torque: max. 1Nm
 Terminal capacity:
 1 x 0.5 to 2.5mm² with/without multicore cable end
 1 x 4mm² without multicore cable end
 2 x 0.5 to 1.5mm² with/without multicore cable end
 2 x 2.5mm² flexible without multicore cable end

► 5. Input circuit

Supply voltage:	
24V DC	terminals A1(+)-A2 voltage selector engaged
24V AC	terminals A1-A2 voltage selector engaged
110 to 240V AC	terminals A1-A2 voltage selector not engaged
Tolerance:	
24V DC	±10%
24V AC	-15% to +10%
110 to 240V AC	-15% to +10%
Rated frequency:	48 to 63Hz
Rated consumption:	
24V AC/DC	1.5VA (1W)
110V AC	2VA (1W)
230V AC	8VA (1.3W)
Duration of operation:	100%
Reset time:	100ms
Residual ripple for DC:	10%
Drop-out voltage:	>30% of the supply voltage

► 6. Output circuit

1 potential free change over contact
 Switching capacity (distance < 5mm): 1250VA (5A / 250V AC)
 Switching capacity (distance > 5mm): 2000VA (8A / 250V AC)
 Fusing: 8A fast acting
 Mechanical life: 20 x 10⁵ operations
 Electrical Life: 2 x 10⁵ operations at 1000VA resistive load
 max. 60/min at 100VA resistive load
 max. 6/min at 1000VA resistive load (according to IEC 947-5-1)
 Insulation voltage: 250V AC (according to IEC 664-1)
 Surge voltage: 4kV, overvoltage category III (according to IEC 664-1)

► 7. Control contact

Connections: not potential free, terminals A1-B1
 Loadable: yes, parallel load min. 1VA (0.5W) terminals A2-B1
 Line length: max. 10m
 Control pulse length: DC min. 50ms
 AC min. 50ms

► 8. Accuracy

Base accuracy: ±1% (of maximum scale value)
 Adjustment accuracy: ≤5% (of maximum scale value)
 Repetition accuracy: <1% or ±10ms
 Voltage influence: -
 Temperature influence: ≤0.01% / °C

► 9. Ambient conditions

Ambient temperature: -25 to +55°C (according to IEC 68-1)
 -25 to +40°C (according to UL 508)
 Storage temperature: -25 to +70°C
 Transport temperature: -25 to +70°C
 Relative humidity: 15% to 85% (according to IEC 721-3-3 class 3K3)
 Pollution degree: 3 (according to IEC 664-1)

► 10. Dimensions

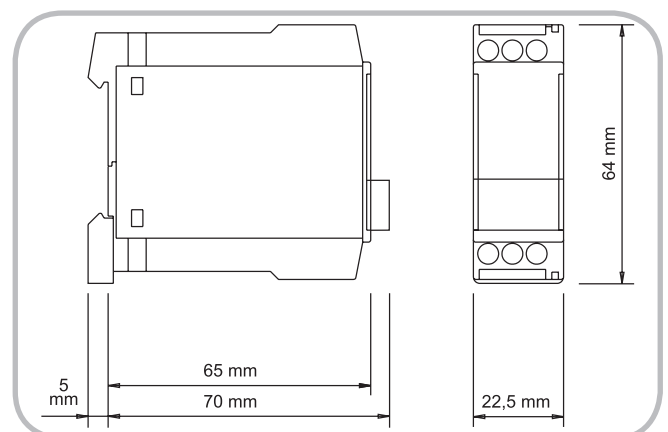

Functions

ON delay (E)

When the supply voltage U is applied, the set interval t begins (green LED flashes). After the interval t has expired (green LED illuminated) the output relay R switches into on-position (yellow LED illuminated). This status remains until the supply voltage is interrupted. If the supply voltage is interrupted before the expiry of the interval t, the interval already expired is erased and is restarted when the supply voltage is next applied.

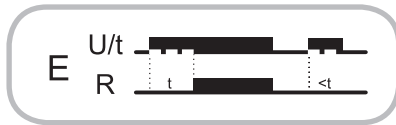

OFF delay with control contact (R)

The supply voltage U must be constantly applied to the device (green LED illuminated). When the control contact S is closed, the output relay R switches into on-position (yellow LED illuminated). If the control contact is opened, the set interval t begins (green LED flashes). After the interval t has expired (green LED illuminated) the output relay switches into off-position (yellow LED not illuminated). If the control contact is closed again before the interval t has expired, the interval already expired is erased and is restarted with the next cycle.

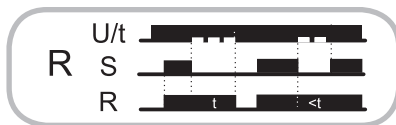

Single shot leading edge with control contact (Ws)

The supply voltage U must be constantly applied to the device (green LED illuminated). When the control contact S is closed, the output relay R switches into on-position (yellow LED illuminated) and the set interval t begins (green LED flashes). After the interval t has expired (green LED illuminated) the output relay switches into off-position (yellow LED not illuminated). During the interval, the control contact can be operated any number of times. A further cycle can only be started when the cycle run has been completed.

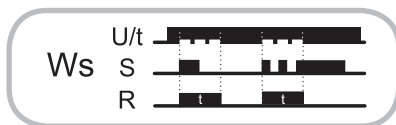

Single shot trailing edge with control contact (Wa)

The supply voltage U must be constantly applied to the device (green LED illuminated). Closing the control contact S has no influence on the condition of the output relay R. When the control contact is opened, the output relay switches into on-position (yellow LED illuminated) and the set interval t begins (green LED flashes). After the interval t has expired (green LED illuminated), the output relay switches into off-position (yellow LED not illuminated). During the interval, the control contact can be operated any number of times. A further cycle can only be started when the cycle run has been completed.

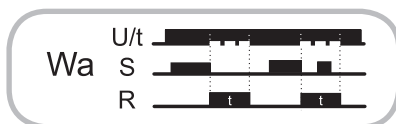

ON delay with control contact (Es)

The supply voltage U must be constantly applied to the device (green LED illuminated). When the control contact S is closed, the set interval t begins (green LED flashes). After the interval t has expired (green LED illuminated) the output relay R switches into on-position (yellow LED illuminated). This status remains until the control contact is opened again. If the control contact is opened before the interval t has expired, the interval already expired is erased and is restarted with the next cycle.



Single shot leading edge voltage controlled (Wu)

When the supply voltage U is applied, the output relay R switches into on-position (yellow LED illuminated) and the set interval t begins (green LED flashes). After the interval t has expired (green LED illuminated) the output relay switches into off-position (yellow LED not illuminated). This status remains until the supply voltage is interrupted. If the supply voltage is interrupted before the interval t has expired, the output relay switches into off-position. The interval already expired is erased and is restarted when the supply voltage is next applied.

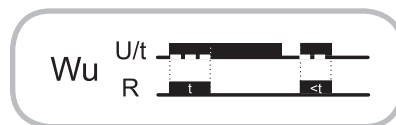

Flasher pause first (Bp)

When the supply voltage U is applied, the set interval t begins (green LED flashes). After the interval t has expired, the output relay R switches into on-position (yellow LED illuminated) and the set interval t begins again. After the interval t has expired, the output relay switches into off-position (yellow LED not illuminated). The output relay is triggered at a ratio of 1:1 until the supply voltage is interrupted.

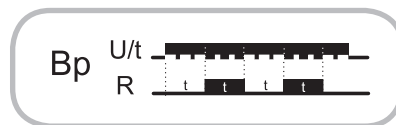

Pulse detection (Wt)

When the supply voltage U is applied (green LED illuminated), the output relay R switches into on-position (yellow LED illuminated). When the control contact S is closed, the set interval t begins (green LED flashes). So that the output relay remains in on-position, the control contact must be opened and closed again within the set interval t. If this does not happen, the output relay switches into off-position and all further pulses at the control contact are ignored. To restart the function the supply voltage must be interrupted and re-applied.

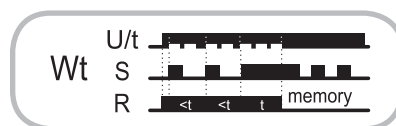

Connections

