

# MRK GUIDE



## CATALOGS

- 4 Condition**
- 5 Gimatic Guide Lines**
- 6 Exhibition Check List**
- 9 Brochure**
  - BRO-2021-EN
  - BRO-2021-IT
  - BRO-2021-ES
  - BRO-2021-CZ
  - BRO-2021-RU
  - BRO-2021-RO
  - BRO-2021-CN
  - BRO-2021-KR
  - BRO-2021-JP
  - BRO-2021-PL
  - BRO-2021-HU
  - BRO-2021-TR
- 10 Vacuum Catalogue**
  - CAT-VACUUM-2021-EN
  - CAT-VACUUM-2021-US
  - CAT-VACUUM-2021-DE
  - CAT-VACUUM-2021-FR
  - CAT-VACUUM-2021-ES
  - CAT-VACUUM-2021-PT
  - CAT-VACUUM-2021-PL
  - CAT-VACUUM-2021-CZ
  - CAT-VACUUM-2021-RU
  - CAT-VACUUM-2021-RO
  - CAT-VACUUM-2021-BG
  - CAT-VACUUM-2021-TR
  - CAT-VACUUM-2021-CN
  - CAT-VACUUM-2021-JP
  - CAT-VACUUM-2021-KR
  - CAT-VACUUM-2021-HU
  - CAT-VACUUM-2021-SE
  - CAT-VACUUM-2021-TH
- 11 EOAT Catalogue**
  - CAT-2020-IT-EN
  - CAT-2020-US-EN
  - CAT-2020-DE-EN
  - CAT-2020-FR-EN
  - CAT-2020-ES-EN
  - CAT-2020-PT-EN
  - CAT-2020-PL-EN
  - CAT-2020-CZ-EN
  - CAT-2020-RU-EN
  - CAT-2020-RO-EN
  - CAT-2020-BG-EN
  - CAT-2020-TR-EN
  - CAT-2020-CN-EN
  - CAT-2020-JP-EN
  - CAT-2020-KR-EN
  - CAT-2020-HU-EN
- 12 FLYER**

## EXHIBITIONS

- 12 USB-MOVIE**
  - USB-MOVIE-V
  - USB-MOVIE-C
  - USB-MOVIE-RE
  - USB-MOVIE-EP
  - USB-MOVIE-SC
  - USB-MOVIE-A
  - USB-MOVIE-2
  - USB-MOVIE-MM
  - USB-MOVIE-R
  - USB-MOVIE-E
  - USB-MOVIE-R
  - USB-MOVIE-AR
- 14 POSTERS**
- 15 Stand accesories - Gadget - Corporate accesories**
- 20 WOOD BOXES - CARTON BOXES**
- 21 PAN MULTILANGUAGE PAN APPLICATION**
- 22 PAN MULTILANGUAGE**
  - PAN-31, PAN-32, PAN-33, PAN-36, PAN-37, PAN-38
- 23 PAN MULTILANGUAGE**
  - PAN-39, PAN-40, PAN-41, PAN-43, PAN-44, PAN-45
- 24 PAN MULTILANGUAGE**
  - PAN-47
- 25 DISPLAY-25**
  - Plastics demo display (4x)
  - EOAT demo display (1x)
- 27 DISPLAY-27**
  - EOAT demo display
- 29 DISPLAY-27-7**
  - EOAT with headlight lens
- 30 DISPLAY-31 e DISPLAY-37**
  - EOAT demo display & Carbon Fiber Eoat
- 31 DISPLAY-36**
  - Handling-Mechatronics demo display (4x)
- 33 DISPLAY-42**
  - Bumper demo display
- 35 DISPLAY-46**
  - Bumper demo display
- 37 DISPLAY-48**
  - Display new product Gimatic
- 39 DISPLAY-49**
  - Robot UR5+RPF
- 40 DISPLAY-51**
  - EOAT Demo display
- 41 DISPLAY-50**
  - Robot display

## EXHIBITIONS

- 43 Tool box**
- 44 START-CASE SB2T**
- 45 VACUUM CASE**
- 46 HANDLING-MECHA-CASE**
  - HANDLING BLISTER
  - MECHA BLISTER
- 47 PLASTICS-CASE**
  - PLASTICS-BLISTER-01
  - PLASTICS-BLISTER-02
  - PLASTICS-BLISTER-03
- 48 Contact document**
- 50 Exhibition booth examples**
- 51 Trade exhibition review**

## PAPER MARKETING

- 53 PAPER MARKETING**
  - COVER STORY
  - INTERNAL ADVERTAISE
  - EDITORIAL
  - CASE HISTORY

## WEB MARKETING

- 54 Paper Marketing Check List**
  - Paper Marketing Plan
- 55 WEB MARKETING**
  - SOCIAL
  - PORTALS
- 56 Web Marketing Check List**
  - Web Marketing Plan

# CONDITIONS

We kindly ask you to spend a little part of your precious time to think and communicate us the events/fairs you will intend take part to, when they will be exactly and which material you would like to show.

To make easy this organization, we think that the present guide could help you.

In this guide you could find some memo to arrange an event, the material list that Gimatic makes available for that (advertising material, gadget, frames/displays of all our products) and relative ordering codes.

## PRICES

As you could see on this guide, we have thought to give you the possibility to buy at a special price some optional for expo only like bag-older, brochure table and so on.

About catalogues, considering the importance of the advertising material we are using, we are compelled to apply a symbolic price to avoid an indiscriminate distribution.

We repeat the importance of a good organization and we push you to look at our Marketing Guide and book as soon as possible the necessary goods for your event.

Please send your "official order" using ordering codes that you can find on this manual. We will try to satisfy all your needs.

## SHARING COSTS

At least but not last, the important topic of "costs": it will be very helpful for Gimatic to get an idea of the "fees" necessary to participate to the event we are going to arrange. In the last pages of this guide there is an Exhibition Report (you can ask for an excel version) which will help you with the budget of your exhibition.

Gimatic wants to participate at the exhibition costs and do it paying one way of the transport. This means we organize and pay the pick-up of the goods from our warehouse to the destination (exhibition or Companies); otherwise the return of the goods it's up to the distributor/subsidiary.

This means the recipient has to follow all the parts of the transport, not only the cost but its organization too. The distributor/subsidiary has to be interested in all the activities and be the referent of its exhibition.

## REFOUND

The distributor/subsidiary must be diligent in checking the integrity of the goods on arrival, otherwise it will be considered directly responsible to GIMATIC for any loss or damage, even if the liability of the carrier.

The distributor/subsidiary is responsible for the goods ordered until its return in our warehouse; Gimatic reserves the right to invoice the damage goods or those not returned back.

# GIMATIC GUIDE LINES

In order to increase the brand awareness and have the same image worldwide we like to establish some Guide lines:

## LOGO

Use the same Gimatic + Barnes logo ( e.g. do not use Gimatic France, Gimatic Iberia,...)  
Use the same colours tone of red and grey as Gimatic Hq:

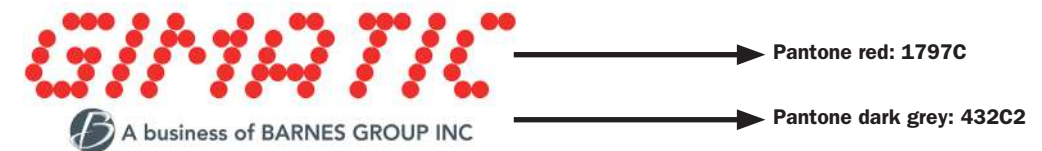

## EXHIBITIONS



All the booths must have the same style and concept (see the photo) , send us an idea or sketch for the approval, you can contact us before if you need some help.

## BUSINESS CARD

Each business card should have the same layout:



- Send us all the information (name, surname, role,..) and we will complete the file, then If you want you can print it by yourself.
- Gimatic + Barnes logo always and only. Sub's name are not valide.
- ONLY three types of business cards:
  1. One language (Latin characters) with white back side;
  2. Double language (Local on the front, English on the back side);
  3. One language (Latin characters on the back) and picture on the front side.
- If you have a special request send us an e-mail for the approval.
- You can print the business cards on your own, but they should have the same layout as ours.
- We can prepared the PDF files for you and you can print it by yourself.
- Or we can prepare the PDF for you and print it for you.

## PHOTO



As we all use Office 365 we should align the photo in the e-mail (same white back ground colour, see the example)

# EXHIBITION CHECK LIST

Ask excel version to Gimatic

Our goal is to define Best Successful Points for Successful Exposition as follow:

## Year Before

- Have you found the Best Exhibition for our Market in your area (Plastics, Handling, Mecha, Sens)?
- Have you seen previous Exhibition Report (visitors, exhibitors...)?
- 
- 

## Months Before

- Have you defined appropriate exposition dimensions floor (price/sq.m)?
- Who realize the booth structure (price)?
- There is Exhibition Advertise opportunity?
- Have you chosen Dynamic Displays as your space?
- Do you have checked exhibition facilities (Electricity, Air pressure, ...)?
- Have you chosen Static Displays for wall or totem application?
- Do you need any Demo-Case on the booth?
- How many Catalogues do you need, languages?
- It is necessary to provide Price Lists with Plastic Catalogue?
- How many Brochures do you need?
- Do you have brochures multilayer holder?
- Do you need USB for monitors or LCD screen?
- Do you want any USB for customers?
- How many Gimatic Bags you need? (n° of visitors, days, ...)
- Do you have special brackets to hold them?
- How many Gimatic Pens you need?
- Do you want some Gimatic USB for key customers?
- Do you want different Gimatic Gadget such as Business Card Holder?
- Have you plan Good deliveries ?
- Have you plan Accommodation?
- Have you plan people Transportation?
- 
- 
- 
- 

## Weeks Before

- Do you need Coffee machine at the booth?
- Have you engaged Sales people?
- Do they need any Sales training?
- Do you need Gimatic Sales/Technical people?
- Have you engaged Hostess with language skills, if necessary?
- Do you need Gimatic products samples?
- Do you think is necessary to attend or arrange After show events?
- 
- 

## Days Before

- Have you arrange booth cleaning?
- Do you have contacts leads document?
- Have you prepared Food and Beverage?
- Define an appropriate dress code?
- Define appropriate behaviour rules which have to be followed on the stand
- Check that all the material exposed on the stand is not damaged and that works perfectly
- Define the exhibition main themes/arguments
- Define the person in charge for all the things that concentering the stand
- 

## During Exhibition

- Check competitors booth location and visit them
- Collect as many contacts as possible using our "contact document"
- Check that all the display exposed are working in the right way
- 
- 

## After Exhibition

- Fill the excel file with all the contacts collected in order to make a segmentation
- Remember to scan each contact document and give it the same number of the excel file
- Thanksgiving send a mail to everyone who has visited you to say thanks
- Send all the material requested (catalogues, brochures...)
- Inform the Gimatic HQ about any suggestion/improvement
-



# EXHIBITION BEHAVIOUR

## Contact Report

- Fill in the form writing more information as you can
- Every time is good job to add a comment about the interview done at the customer
- Mark any deadline
- 
- 

## On the stand

- Remember to promote the main theme of the fair ("Have you seen the newest solution we are showing...?")
- Time spent for each customer has to be optimized
- A dress code has to be respected
- Use of mobiles, tablet and PC has to be limited. In case of need please, don't stay on the stand in front of the people
- The material (leaflet, brochures, bags, pen...) has to be always available.
- Note all the problems happened during the exhibition
- Record contact leads during the fair (in the free time)
- Make the right questions ("How many injection presses do you have?")
- Don't stay with hands in your pocket
- Prepare references of people all over the world (in addition to the list on the Brochure)

Ask excel version to Gimatic

# BROCHURE



	Languages	Edition	Format	Package	Weight carton box	Symbolic price
<b>BRO-2021-EN</b>	EN	01/2021	A4 (21x29.7 cm) 32 pages	25 pcs cellophane package 125 pcs carton box package 30x23x27 cm carton box	17 kg	€ 0,10
<b>BRO-2021-IT</b>	IT					
<b>BRO-2021-ES</b>	ES					
<b>BRO-2021-CZ</b>	CZ					
<b>BRO-2021-RU</b>	RU					
<b>BRO-2021-RO</b>	RO					
<b>BRO-2021-CN</b>	CN					
<b>BRO-2021-KR</b>	KR					
<b>BRO-2021-JP</b>	JP					
<b>BRO-2021-PL</b>	PL					
<b>BRO-2021-HU</b>	HU					
<b>BRO-2021-TR</b>	TR					

# PRICE LIST (EXCEL VERSION)

Listino di vendita Gimatic

Catalogo	Codice	Descrizione	Description	UM	Min	Prezzo/Tip	Det
PLASTICI	379284-02	LAMA TRAPEZIO-GRANDE (21x14,5)	Spine blade (20 per package)	NR	0,00	€11,70	
PLASTICI	5E16	LAMA TRAPEZIO (1,5 BLADE)	Wiper blade	NR	0,00	€143,48	
PLASTICI	5E17	LAMA PISA (1,5 BLADE)	Wiper blade	NR	0,00	€55,84	
PLASTICI	5E18	LAMA TRAPEZIO (2M BLADE)	Wiper blade	NR	0,00	€125,63	
PLASTICI	5E20	LAMA PISA (2M BLADE)	Wiper blade	NR	0,00	€43,89	
PLASTICI	351020	SPRING FOR BLADE	Spring for blade (100x4)/100x4	NR	0,00	€4,50	
PLASTICI	351022	SPRING FOR BLADE	Spring for blade (100x4)/100x2	NR	0,00	€4,50	
PLASTICI	351024	SPRING FOR BLADE	Spring for blade (100x4)/100x1	NR	0,00	€6,50	
PLASTICI	351026	SPRING FOR BLADE	Spring for blade (100x4)	NR	0,00	€6,50	
PLASTICI	AA-02	PINDA ANGOLORE DIA. 30	Spine gripper	NR	0,00	€28,84	
PLASTICI	AA-02-40	PINDA ANGOLORE DIA.30 MOLLA APERT.	Spine gripper	NR	0,00	€28,84	
PLASTICI	AA-03	PINDA ANGOLORE DIAM. 30	Spine gripper	NR	0,00	€28,25	
PLASTICI	AA-03-40	PINDA ANGOLORE DIAM. 30	Spine gripper	NR	0,00	€28,25	
PLASTICI	AA-05	PINDA ANGOLORE SERIE AA	Spine gripper	NR	0,00	€28,24	
PLASTICI	AA-05-40	PINDA ANGOLORE SERIE AA	Spine gripper	NR	0,00	€28,24	
PLASTICI	AA-05	PINDA ANGOLORE	Spine gripper	NR	0,00	€28,64	
PLASTICI	AA-05-40	PINDA ANGOLORE	Spine gripper	NR	0,00	€28,64	
PLASTICI	AF0540M	ADDEME NIFLO MASCHIO M5-M8	Wipple male-male	NR	0,00	€1,48	
PLASTICI	AF1301M	ADATTATORE ELR PER PINZE	ADAPTER FITTING FOR PG GRIPPERS	NR	0,00	€40,50	
PLASTICI	AF1312M	KIT CODULO CDN DADI	Adapter for MFC/MFU grippers	NR	0,00	€30,50	
PLASTICI	AF1401M	ADDEME NIFLO MASCHIO 1/8-1/4	Wipple male-male	NR	0,00	€2,91	
PLASTICI	AF1701M	KIT CODULO CDN DADI	Adapter for MFC/MFU grippers	NR	0,00	€20,50	
PLASTICI	AF1901M	ADDEME NIFLO MASCHIO 1/8-1/8	Wipple male-male	NR	0,00	€1,87	
PLASTICI	AF1903M	KIT CODULO CDN DADI	Adapter for MFC/MFU grippers	NR	0,00	€43,50	
PLASTICI	AD024-B	PINDA PER ASSICAMMENTO Ø20	Gripper for engagement dia. 20	NR	0,00	€20,50	
PLASTICI	AD024-C	PINDA PER ASSICAMMENTO Ø20	Gripper for engagement dia. 20	NR	0,00	€20,50	
PLASTICI	AD024-D	PINDA PER ASSICAMMENTO Ø20	Gripper for engagement dia. 20	NR	0,00	€20,50	
PLASTICI	AD024-E	PINDA PER ASSICAMMENTO Ø20	Gripper for engagement dia. 20	NR	0,00	€20,50	
PLASTICI	AD024-F	PINDA PER ASSICAMMENTO Ø20	Gripper for engagement dia. 20	NR	0,00	€20,50	
PLASTICI	AD024-G	PINDA PER ASSICAMMENTO Ø20	Gripper for engagement dia. 20	NR	0,00	€20,50	
PLASTICI	AD024-H	PINDA PER ASSICAMMENTO Ø20	Gripper for engagement dia. 20	NR	0,00	€20,50	
PLASTICI	AD024-I	PINDA PER ASSICAMMENTO Ø20	Gripper for engagement dia. 20	NR	0,00	€20,50	
PLASTICI	AD024-J	PINDA PER ASSICAMMENTO Ø20	Gripper for engagement dia. 20	NR	0,00	€20,50	
PLASTICI	AD024-K	PINDA PER ASSICAMMENTO Ø20	Gripper for engagement dia. 20	NR	0,00	€20,50	
PLASTICI	AD024-L	PINDA PER ASSICAMMENTO Ø20	Gripper for engagement dia. 20	NR	0,00	€20,50	
PLASTICI	AD024-M	PINDA PER ASSICAMMENTO Ø20	Gripper for engagement dia. 20	NR	0,00	€20,50	
PLASTICI	AD024-N	PINDA PER ASSICAMMENTO Ø20	Gripper for engagement dia. 20	NR	0,00	€20,50	
PLASTICI	AD024-O	PINDA PER ASSICAMMENTO Ø20	Gripper for engagement dia. 20	NR	0,00	€20,50	
PLASTICI	AD024-P	PINDA PER ASSICAMMENTO Ø20	Gripper for engagement dia. 20	NR	0,00	€20,50	
PLASTICI	AD024-Q	PINDA PER ASSICAMMENTO Ø20	Gripper for engagement dia. 20	NR	0,00	€20,50	
PLASTICI	AD024-R	PINDA PER ASSICAMMENTO Ø20	Gripper for engagement dia. 20	NR	0,00	€20,50	
PLASTICI	AD024-S	PINDA PER ASSICAMMENTO Ø20	Gripper for engagement dia. 20	NR	0,00	€20,50	
PLASTICI	AD024-T	PINDA PER ASSICAMMENTO Ø20	Gripper for engagement dia. 20	NR	0,00	€20,50	
PLASTICI	AD024-U	PINDA PER ASSICAMMENTO Ø20	Gripper for engagement dia. 20	NR	0,00	€20,50	
PLASTICI	AD024-V	PINDA PER ASSICAMMENTO Ø20	Gripper for engagement dia. 20	NR	0,00	€20,50	
PLASTICI	AD024-W	PINDA PER ASSICAMMENTO Ø20	Gripper for engagement dia. 20	NR	0,00	€20,50	
PLASTICI	AD024-X	PINDA PER ASSICAMMENTO Ø20	Gripper for engagement dia. 20	NR	0,00	€20,50	
PLASTICI	AD024-Y	PINDA PER ASSICAMMENTO Ø20	Gripper for engagement dia. 20	NR	0,00	€20,50	
PLASTICI	AD024-Z	PINDA PER ASSICAMMENTO Ø20	Gripper for engagement dia. 20	NR	0,00	€20,50	

# VACUUM CATALOGUE



	Languages	Edition	Format	Package	Weight carton box	Symbolic price
<b>CAT-VACUUM-2021-EN</b>	IT-EN	01/2021	A4 (21x29.7 cm) pages	PDF version only		€ 1,00
<b>CAT-VACUUM-2021-US</b>	USA-EN					
<b>CAT-VACUUM-2021-DE</b>	DE-EN					
<b>CAT-VACUUM-2021-FR</b>	FR-EN					
<b>CAT-VACUUM-2021-ES</b>	ES-EN					
<b>CAT-VACUUM-2021-PT</b>	PT-EN					
<b>CAT-VACUUM-2021-PL</b>	PL-EN					
<b>CAT-VACUUM-2021-CZ</b>	CZ-EN					
<b>CAT-VACUUM-2021-RU</b>	RU-EN					
<b>CAT-VACUUM-2021-RO</b>	RO-EN					
<b>CAT-VACUUM-2021-BG</b>	BG-EN					
<b>CAT-VACUUM-2021-TR</b>	TR-EN					
<b>CAT-VACUUM-2021-CN</b>	CN-EN					
<b>CAT-VACUUM-2021-JP</b>	JP-EN					
<b>CAT-VACUUM-2021-KR</b>	KR-EN					
<b>CAT-VACUUM-2021-HU</b>	HU-EN					
<b>CAT-VACUUM-2021-SE</b>	SE-EN					
<b>CAT-VACUUM-2021-TH</b>	TH-EN					

# EOAT CATALOGUE



## 2020 EDITION

	Languages	Edition	Format	Package	Weight carton box	Symbolic price
<b>CAT-2020-IT-EN</b>	IT-EN	09/2019	A4 (21x29.7 cm) 664 pages	5 pcs cellophane package 10 pcs carton box package 24x22x31 cm carton box	15,25 kg	€ 2,00

## 2021 EDITION

	Languages	Edition	Format	Package
<b>CAT-2020-IT-EN</b>	IT-EN	2021	A4 (21x29.7 cm) 1026 pages	PDF version only
<b>CAT-2020-DE-EN</b>	DE-EN			
<b>CAT-2020-FR-EN</b>	FR-EN			
<b>CAT-2020-ES-EN</b>	ES-EN			
<b>CAT-2020-PT-EN</b>	PT-EN			
<b>CAT-2020-PL-EN</b>	PL-EN			
<b>CAT-2020-CZ-EN</b>	CZ-EN			
<b>CAT-2020-RU-EN</b>	RU-EN			
<b>CAT-2020-RO-EN</b>	RO-EN			
<b>CAT-2020-BG-EN</b>	BG-EN			
<b>CAT-2020-TR-EN</b>	TR-EN			
<b>CAT-2020-CN-EN</b>	CN-EN			
<b>CAT-2020-JP-EN</b>	JP-EN			
<b>CAT-2020-KR-EN</b>	KR-EN			
<b>CAT-2020-HU-EN</b>	HU-EN			
<b>CAT-2020-SE-EN</b>	SE-EN			
<b>CAT-2020-TH-EN</b>	TH-EN			



Ask to Gimatic the flyer with the news of products

Symbolic price: € 0,05

Flyers available:

- GIMATIC/ BARNES
- GIMATIC VACUUM
- VACUUM PUMPS
- SUCTION CUPS
- VACUUM ACCESORIES
- XP-HS/ SX-SXT
- VS\_TF/ VS
- SBM/ SENSOR BOX
- TILT UNIT RBT/ OFN
- QC/ QCY
- GN
- MFU-MFD/ PT
- OF/ OFF
- SQC/ SQM-SQP
- LEVEL COMPENSATORS/ MFI
- SENSORS
- RFID/ MOLD MONITORING
- MECHA OPTION
- GMP
- MPCF SERVO GRIPPER/ MPLF
- RPF/ SUPER CAPBOX-CAPBOX
- EQC05-EQC20-EQC100/ QC75
- KIT-UR
- 3D PRINTING/ 3L-3M
- STARTERBOX
- ZL
- DC-DA-DB SPRUE GRIPPERS
- DD-PB-SPRUE GRIPPER

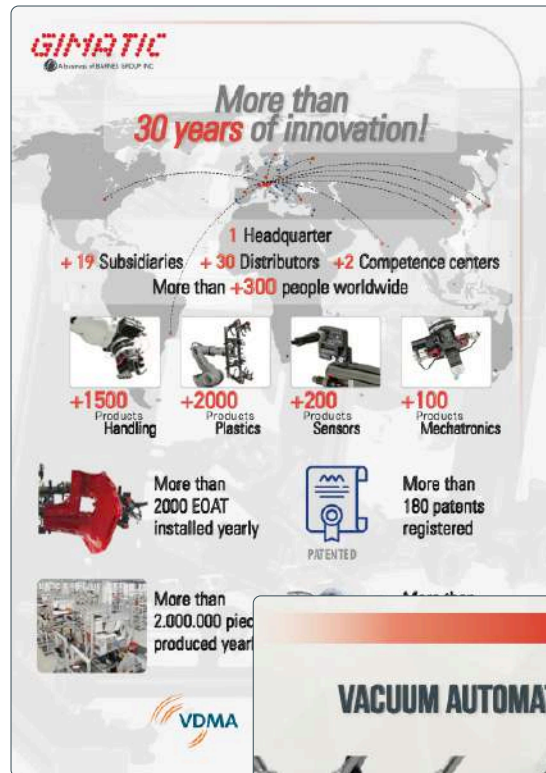

# USB MOVIE

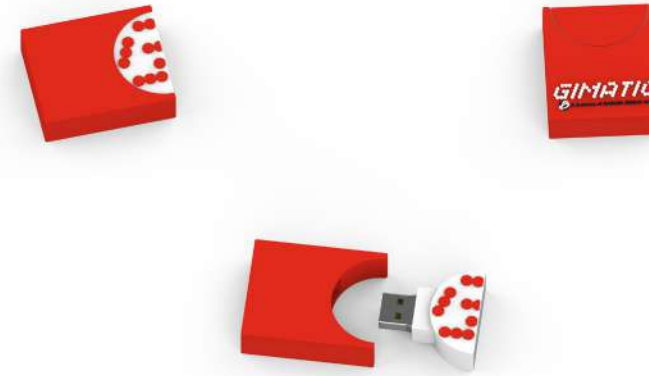

	Type file	Edition	Package	Weight carton box	Symbolic price
<b>USB-MOVIE-V</b> (Vacuum movie)	.mp4 .mov .avi	01/2021	Carton box	0,015 kg	€ 4,00
<b>USB-MOVIE-C</b> (Corporate movie)		01/2019			
<b>USB-MOVIE-RE</b> (RFID+EOAT animation)		04/2019			
<b>USB-MOVIE-EP</b> (EOAT Process movie)		11/2018			
<b>USB-MOVIE-SC</b> (Supercapacitor Box animation)		12/2018			
<b>USB-MOVIE-A</b> (Applications movie)		01/2019			
<b>USB-MOVIE-2</b> (-C,-RE,-EP,-SC,-A movies in loop)		04/2019			
<b>USB-MOVIE-MM</b> (Mold Monitoring movie)		10/2019			
<b>USB-MOVIE-R</b> (RPF movie)		09/2019			
<b>USB-MOVIE-E</b> (EQC20 movie)		09/2019			
<b>USB-MOVIE-AR</b> (Augmented Reality movie)		10/2019			



# POSTERS/STAND GRAPHIC

Ask Gimatic poster file

## Examples

**EOAT POSTER**  
160x160 cm



**PLASTIC POSTER**  
400x330 cm



**MECHA POSTER**  
160x85 cm



# STAND ACCESSORIES



**BROCHURE-TABLE**  
1 piece/box  
0.7 kg  
carton size 33 x 23 x 12 cm  
Free for exhibition  
€ 15,50 (In case of buying)



**BROCHURE-STAND**  
1 piece/box  
Open: 27.5 x 37 x 150 cm  
carton size 47 x 14 x 33 cm  
7 kg  
Free for exhibition  
€ 130,00 (In case of buying)



**BAG-HOLDER**  
1 piece/box  
carton size 35 x 35 x 100 cm  
4,7 kg  
Free for exhibition  
€ 100,00 (In case of buying)



**SHELF-UNIT**  
1 piece/box  
Open 90 x 90 x 35  
carton size 93 x 37 x 11 cm  
8 kg  
Free for exhibition  
€ 80,00 (In case of buying)



**DISPLAY-COVER**  
1 piece/box  
Free for exhibition  
€ 11 (In case of buying)



**FIRST-AID**  
1 piece/box  
30 x 14 x 46 cm  
7,5 kg  
Free for exhibition  
€ 80,00 (In case of buying)



**TROLLEY**  
1 piece  
75 x 25 x 47 cm  
8,5 kg  
Free for exhibition  
€ 50,00 (In case of buying)



**STAIR**  
1 piece  
110 x 20 x 50 cm  
5,6 kg  
Free for exhibition  
€ 50,00 (In case of buying)



**WASTE-BASKET**  
1 piece  
31 x 31 x 32  
0,2kg  
Free for exhibition  
€ 1,50 (In case of buying)



**GARBAGE-BAG**  
1 piece  
6 x 6 x 15  
0,2 kg  
€ 1,00





**PEN-HOLDER**  
1 piece  
0,06 kg  
Free for exhibition  
€ 1,00 (In case of buying)  
10 x 8 x 8 cm



**CONTACT-FOLDER**  
1 piece/box  
35 x 29 x 8 cm  
Free for exhibition  
€ 2,00 (In case of buying)



**PAPER-PUNCH**  
1 piece  
0,2 kg  
Free for exhibition  
€ 10,00 (In case of buying)



**STAPLER**  
1 piece/box  
0,2 kg  
Free for exhibition  
€ 10,00 (In case of buying)



**CLEANING-KIT**  
1 piece  
Paper Roll + Spray Detergent  
20 x 15 x 31 cm  
1 kg  
€ 8,00



**DUST-CAPTURE**  
3 piece/box  
€ 8,00



**STICKER-32**  
1 piece  
32 X 9 cm  
€ 3,00



**STICKER-56**  
1 piece  
56 X 15,8 cm  
€ 6,00



**PLATE**  
1 piece  
0,1 kg  
13,5 x 9 cm x 1mm  
€ 5,00  
The table on the plate is empty to let the user write the EOAT details needed.



**TAPE-ROLL**  
1 piece  
0,3 kg  
€ 0,70

## GADGET



**DIARY**  
1 piece  
0,08 kg  
19 x 21 cm  
€ 3,00

50 pieces/box  
13,5 kg  
carton size 36,5x31,5x23 cm

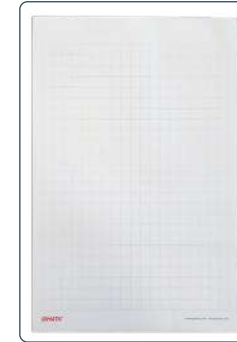

**NOTE**  
A4 / 21 x 29,7 cm  
5 piece/cellophane package  
2,6 kg  
20 piece/carton size 32 x 25 x 24 cm  
10,5 kg  
€ 0,80/piece (Minimum order 5 pieces)



**NOTEBOOK**  
1 piece  
0,08 kg  
19 x 21 cm  
€ 2,00

36 pieces/box  
10,6 kg  
carton size 26x23x30



**PEN**  
Pen  
50 pcs/box  
0,6 kg  
carton size 10 x 10 x 15 cm  
€ 0,30

500 pieces/carton box  
7 kg  
carton size 35x35x13



**DOCUMENTS-FOLDER**  
1 piece  
0,04 kg  
€ 0,40



**TABLE-CALENDAR**  
Calendar with Italian bank holidays  
1 piece  
0,08 kg  
€ 2,00



**ALLENKEY**  
The sizes are  
1.5/2/2.5/3/4/5/6  
0,6 kg  
carton size 10 x 10 x 15 cm  
€ 2,00

120 pieces/carton box  
16.30 kg  
carton size 31x27x17 cm



**VR-VIEWER**  
1 piece/box  
0,35 kg  
carton size 20 x 14 x 11 cm  
€ 5,00

50 pieces/carton box  
18 kg  
carton size 71x41x58 cm



**USB-STICK**  
100 pieces/box  
USB 3.0  
16GB  
0,015 kg/ pieces  
€ 4.00  
(CAD files (dxf/step), Pdf, Manuals)





**POWER-BANK**  
1 piece/box  
USB  
Microusb  
LED Flashlight  
4400 mAh  
0,1 kg  
€ 8,00



**CHARGER**  
1 piece/box  
Wireless battery charger.  
USB cable/microusb included.  
(The device has just to be placed on the charger station. Generally this charger is suitable for the devices that have the Qi technology integrated.)  
5W  
0,1 kg  
€ 5,00  
  
100 pieces/box  
6,5 kg  
carton size 51,5x26x27 cm



**MOBILE-HOLDER**  
1 piece  
0,05 kg  
box size 6,5 x 4 x 5 cm  
€ 4,00  
  
50 pieces/box  
2,6 kg  
carton size  
34x24x10 cm



**ADAPTER-PLUG**  
1 piece  
0,1 kg  
€ 2,50  
  
  
50 pieces/box  
5 kg  
carton size  
46x28x12 cm



**CAP**  
1 piece  
0,1 kg  
€ 3,00



**HOODIE**  
Size: M/L/XL  
28/31 pieces/box  
0,1 kg  
€ 15,00  
  
carton size 40x42x58  
13 kg



**BAG**  
100 pieces/box  
carton size 35 x 45 x 34 cm  
6,4 kg  
€ 0,20



**POLO**  
Size: L  
1 piece  
0,3 kg  
€ 4,00  
  
24 pieces/box  
6kg  
carton size 52 x 38 x 20 cm



**SCARF**  
1 piece  
0,01 kg  
€ 15,00



**TIE**  
1 piece  
0,1 kg  
€ 15,00

## CORPORATE ACCESSORIES



**NAME-PLATE**  
1 piece  
Paper 7,9 x 4,9 cm  
€ 1,50



**PIN**  
1 piece  
3 x 1 cm  
€ 0,60



**BUSINESS-CARD**  
8,5 x 5,5 cm  
250 pieces/box  
€ 0,12/pieces  
(Ask your personal Business card)



**UMBRELLA**  
1 piece  
0,40 kg  
€ 8,00  
  
24 piece/box  
11 Kg  
carton size 39 x 23 x 33 cm



**FLAG**  
1 piece  
Open Height: 240 cm  
carton size 110 x 55 x 20  
2,1 kg  
Free for exhibition.  
€ 135,00 (in case of buying)



**ROLL UP**  
1 piece  
Open Height: 220 cm  
carton size 110 x 55 x 20  
2,1 kg  
Free for exhibition.  
€ 135,00 (in case of buying)



# WOOD BOXES

## 6 position

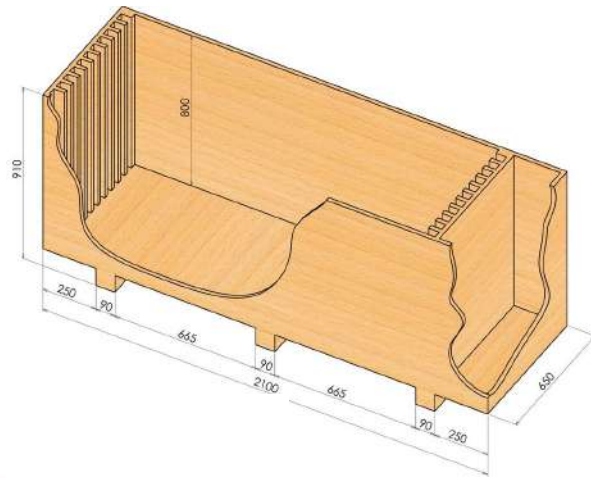
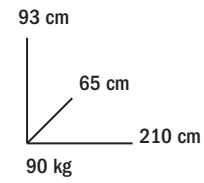

## 12 position

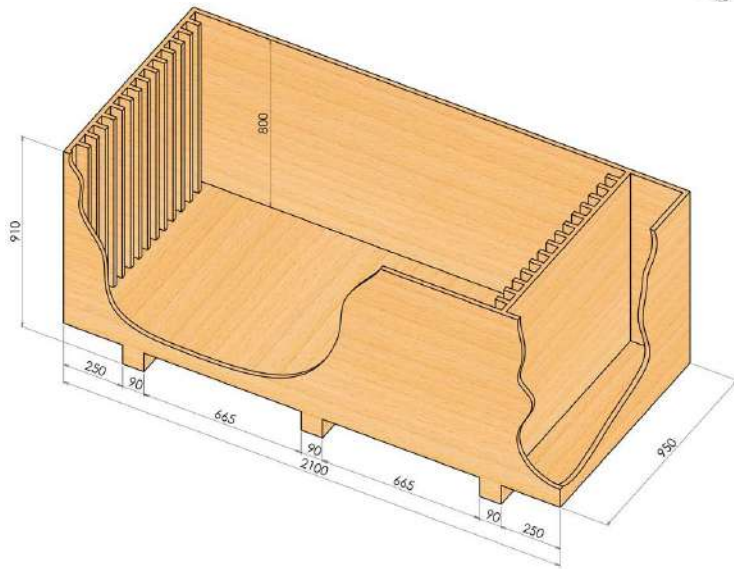
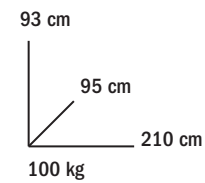

# CARTON BOXES

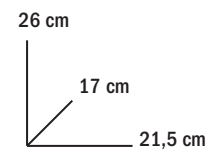

**SCAT.PICCOLA**  
20 pcs pack  
€ 0.26/each  
Dimensions: 260X170X215mm H

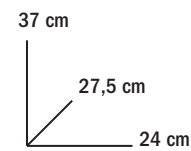

**SCAT.MEDIA**  
10 pcs pack  
€ 0.62/each  
Dimensions 370X275X240mm H

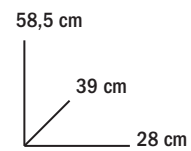

**SCAT.GRANDE**  
10 pcs pack  
€ 1.17/each  
Dimensions 585X390X280mm H

# PAN MULTILANGUAGE

Available languages

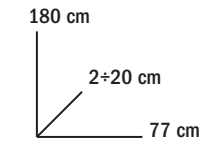

To delivery them you can use our standard wood boxes With 6 or 12 positions.  
See on page 29



# PAN-APPLICATION

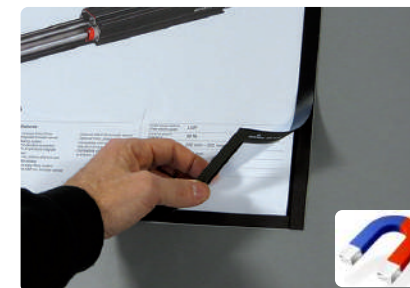
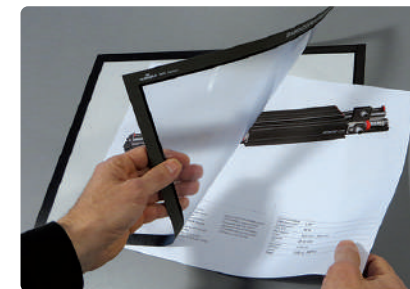

Multilanguage panels application layout.  
It is possible to use our MFI fixing plates  
to realize different positioning.

# PAN MULTILANGUAGE

**PAN-31**  
MPPM, MPXM, MPLM, MPTM  
10 kg



**PAN-32**  
MPBM  
11 kg



**PAN-33**  
EQC, ML, LV, LVP  
13 kg



**PAN-39**  
DH, TH, PQ  
10 kg



**PAN-40**  
MGX, GM, MG  
10 kg



**PAN-41**  
MFD, MFU  
10 kg



**PAN-36**  
RT, R  
10 kg



**PAN-37**  
SGP-S, GS, GW, GX  
11 kg



**PAN-38**  
SX, SXT, SZ, SH  
14 kg



**PAN-43**  
SENSORS  
9 kg

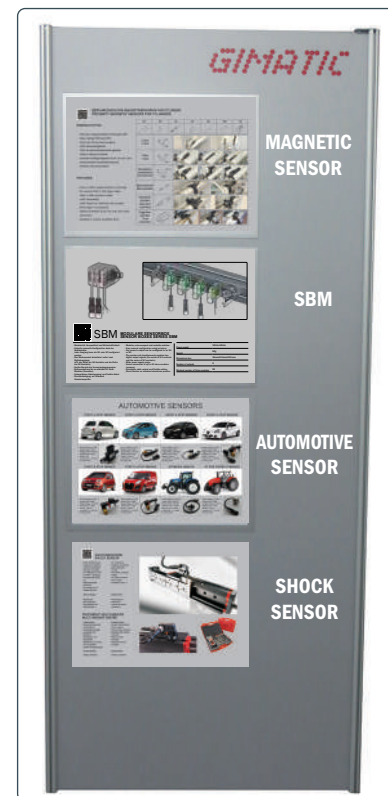

**PAN-44**  
SPECIAL  
9 kg

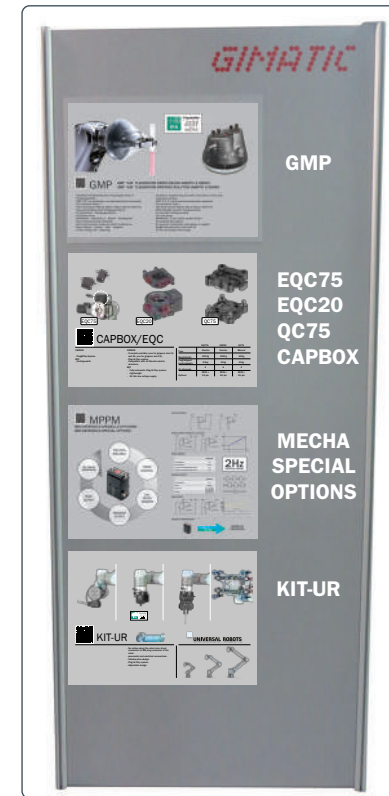

**PAN-45**  
GIMATIC GROUP  
9 kg





# PAN MULTILANGUAGE

PAN-47  
INDUSTRY 4.0  
9 kg



# DISPLAY-25

Display demo Plastics (1-2-3-4) + EOAT demo display (5)

DISPLAY-25-1  
DISPLAY-25-2  
DISPLAY-25-3  
DISPLAY-25-4

DISPLAY-25-5

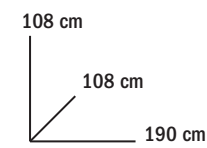

DELIVERY WOOD BOXES  
100 kg

Phytosanitary treatment is not necessary due to the plywood material (ISPM-15)

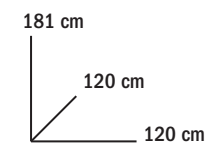

ASSEMBLED FRAME  
110 kg

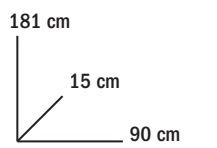

SINGLE FRAME  
32 kg

Power supply	220 Vac
Air Connection	pipe Ø8

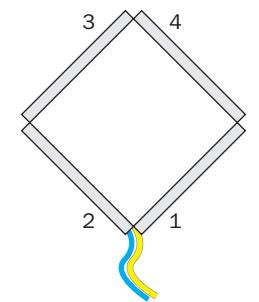
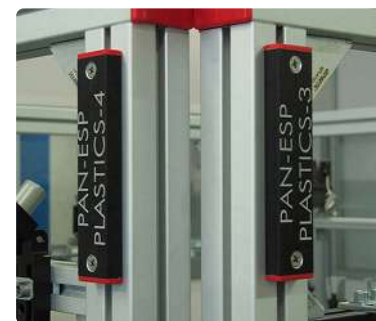

Combine 1-2-3-4 frames as picture



Fix frames with 4 brackets on the top and 4 brackets on the top

Connect Air connection pipes



# DISPLAY-25

## Mounting Frame Gimatic logo on demo display

- A: DISPLAY25 logo mounted in the lower part of the frame for the transport
- B: Knobs to unscrew to remove the logo
- C: Pull up carefully (use two hands)

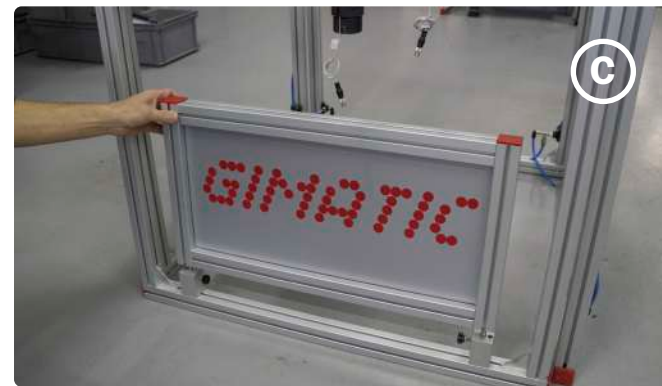

- D: Locking pin
- E: Place the logo on the top of the frame by aligning the pins with the holes
- F: DISPLAY25 logo mounted in the right mode for the exhibition



# DISPLAY-27

## E0AT demo display

185 cm  
120 cm  
158 cm  
ASSEMBLED FRAME  
70 kg

200 cm  
99 cm  
99 cm  
DELIVERY WOOD BOXES  
100 kg  
Phytosanitary treatment is not necessary due to the plywood material (ISPM-15)

Power supply	220 Vac
Air Connection	pipe Ø8

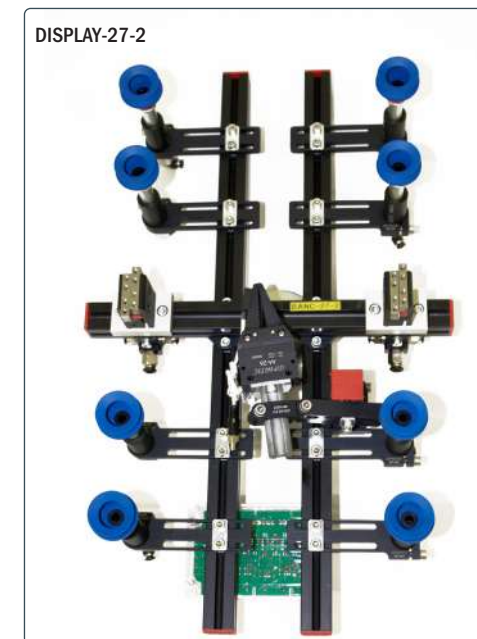
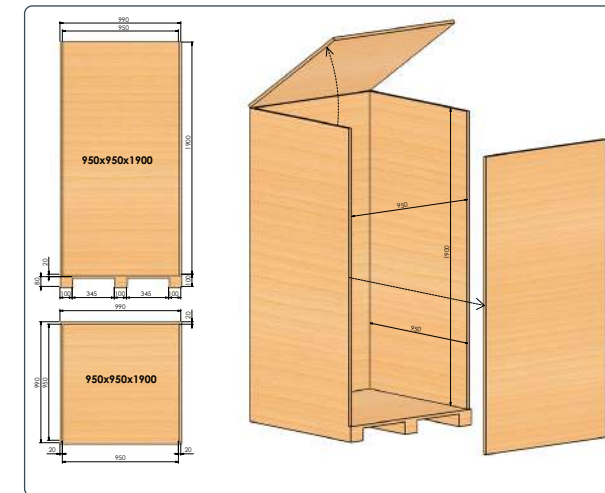



# DISPLAY-27

EOAT demo display

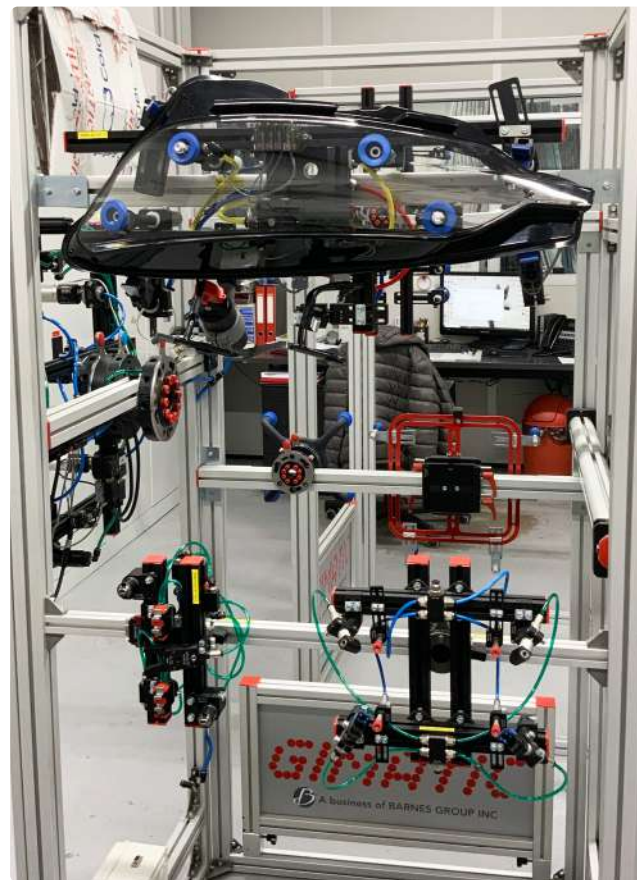

# DISPLAY-27-7

EAOT with headlight lens

30 cm  
40 cm  
60 cm  
DELIVERY WOOD BOXES  
5,8 kg



EMF-2525-2000	1
QCY90-A	1
QCP90-B	1
CQC-012	1
CQC-013	1
MAQC	1
MBQC	1
CEQC-BC	1
DD20-16L2	2
OFR20-95G	2
MFI-A350	3
AV0118M16	4
COJ12	1
SBMM	1

SBMK	1
SBMS	3
RAQC	1
RBQC	1
MFI-A140	4
MFI-A38	4
DD20-16M2	1
MFP-A06	1
V0233H04	4
MFI-A21	1
RG.5511600004	1
MFI-A379	1
MFI-A239	1
MFI-A252	3

SS3N203Y-1	3
VSE2050F18	4
G.N20PF	1
GN-20	1
OF20L100	1
RG.5002000N03	1
RG.5511600013	1
3330082	1
MFI-A217	1

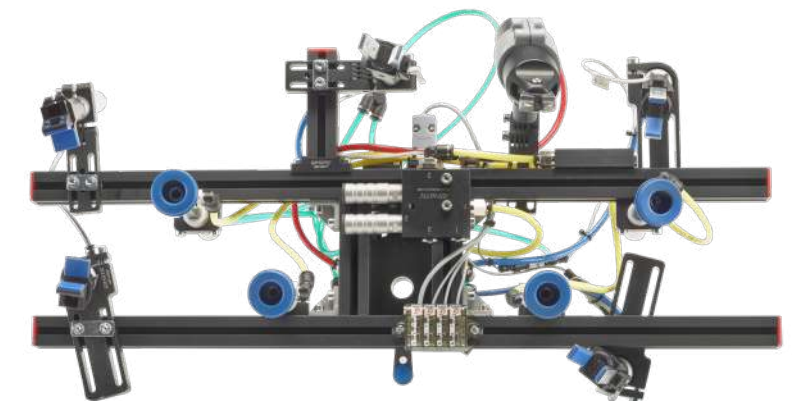
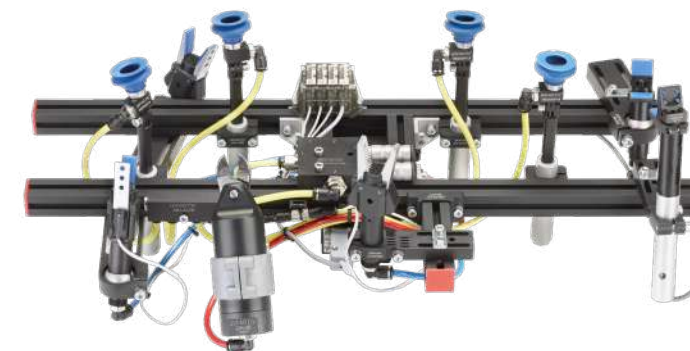



# DISPLAY-31

## Ultralight fiber carbon tubes



178 cm  
67 cm  
82 cm  
FRAME  
29.5 kg

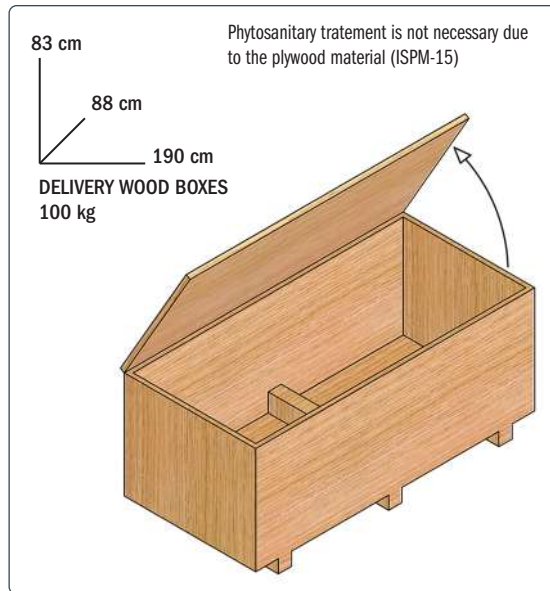

83 cm  
88 cm  
190 cm  
DELIVERY WOOD BOXES  
100 kg  
Phytosanitary treatment is not necessary due to the plywood material (ISPM-15)



ALUMINIUM E-OAT  
10.4 kg

CARBON FIBER E-OAT  
5.6 kg

# DISPLAY-37

## Fiber Carbon E-OAT

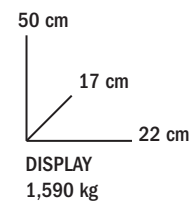

DISPLAY  
1,590 kg

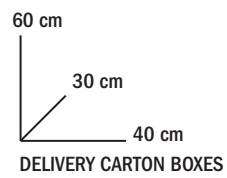

DELIVERY CARTON BOXES

TFC-2017-1500	1
QC90-A	1
QC90-B	1
MFI-A328	1
MFP-K22	1
MFI-A191	4
AV0118M12	4
V0233H04	4



# DISPLAY-36

## Handling-Mechatronics demo display (1-2-3-4)

Power supply	220 Vac
Power Max	1100 W
Power Consumption	360 Wh
Air Connection	Pipe Ø8

DISPLAY-36-1  
DISPLAY-36-2  
DISPLAY-36-3  
DISPLAY-36-4

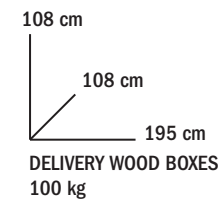

Phytosanitary treatment is not necessary due to the plywood material (ISPM-15)

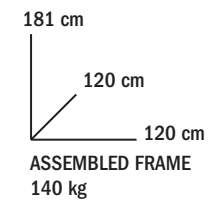

Combine 1-2-3-4 frames as picture

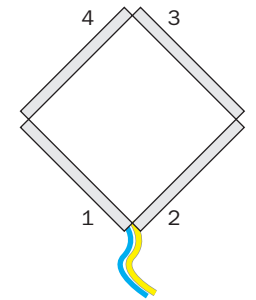

Fix frames with 4 brackets on the top and 4 brackets on the bottom



Connect Air connection pipes



# DISPLAY-36

## Mounting Frame Gimatic logo on demo display

- A: DISPLAY36 logo mounted in the lower part of the frame for the transport
- B: Knobs to unscrew to remove the logo
- C: Pull up carefully (use two hands)

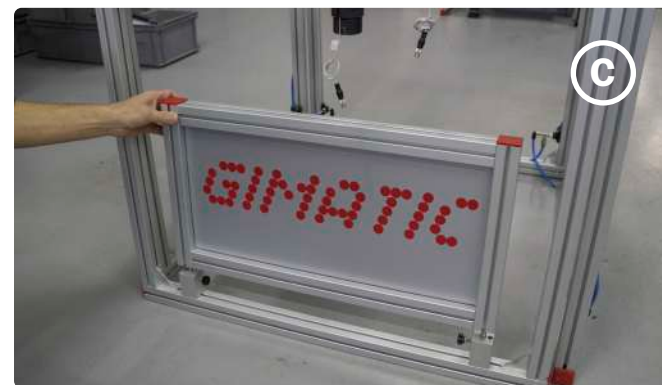

- D: Locking pin
- E: Place the logo on the top of the frame by aligning the pins with the holes
- F: DISPLAY36 logo mounted in the right mode for the exhibition



# DISPLAY-42

## Bumper demo display

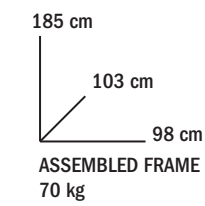

Free for exhibition

€ 2000,00 (in case of buying)

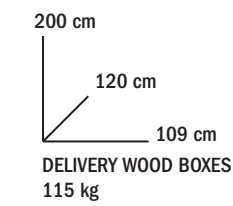

Phytosanitary treatment is not necessary due to the plywood material (ISPM-15)

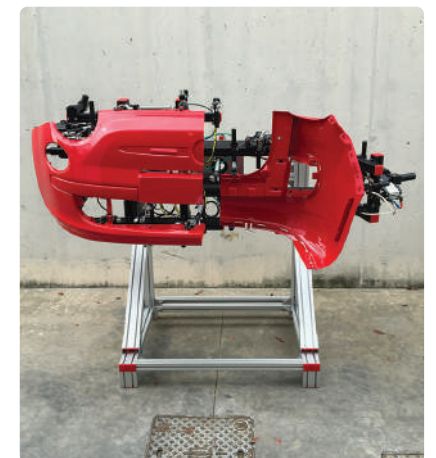
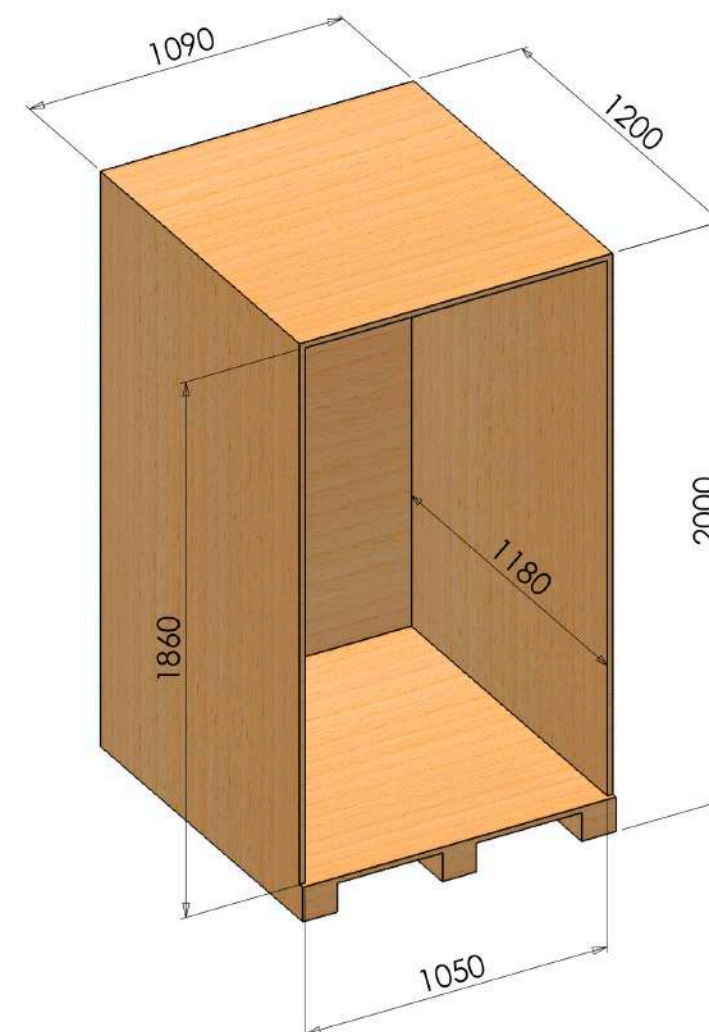



# DISPLAY-42

Bumper demo display

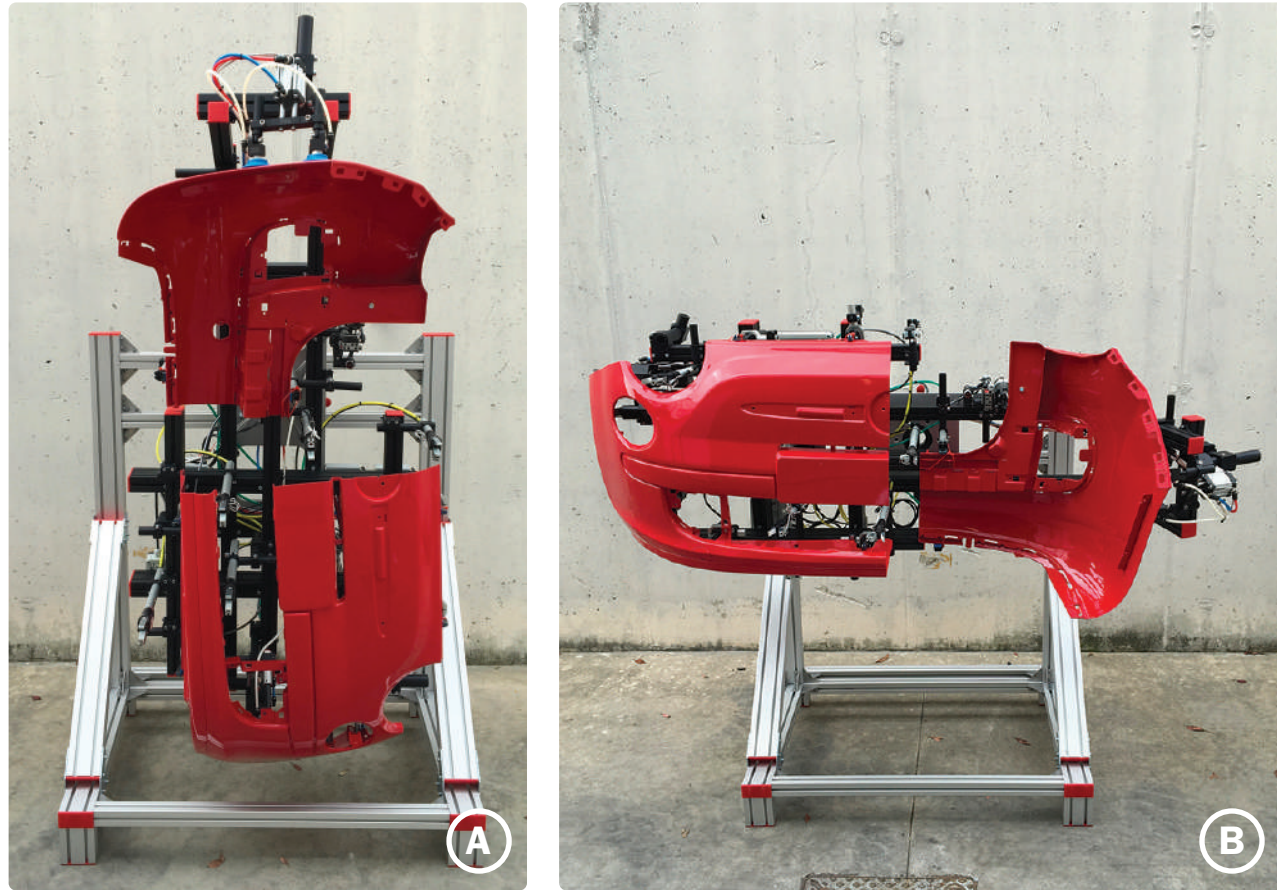

It's possible to show this display in two position, vertical or landscape mode.

The default position is vertical but it is possible to change it unscrewing the screws placed between the quick changer and the frame.

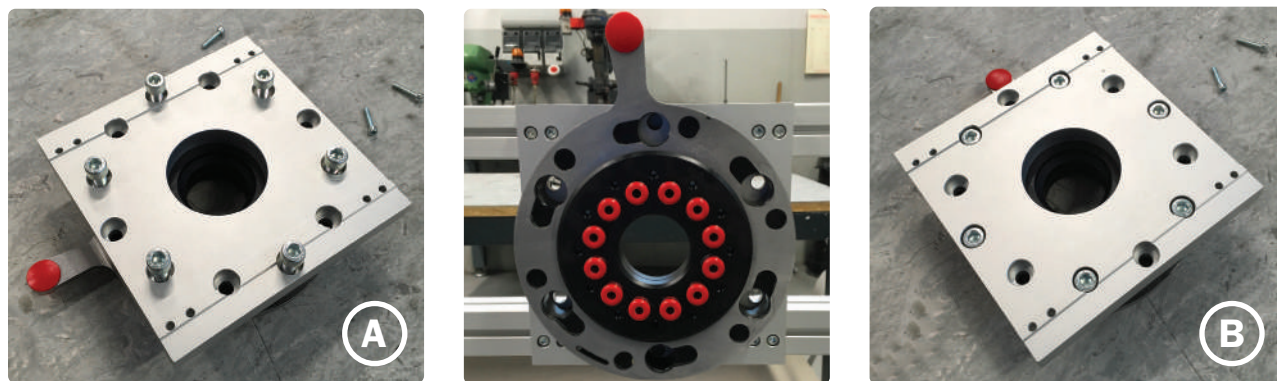

A: Vertical Config.

B: Landscape Config.

# DISPLAY-46

Bumper demo display

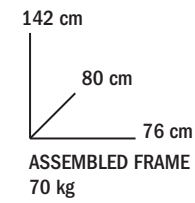

Free for exhibition

€ 2000,00 (in case of buying)

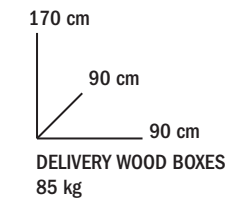

Phytosanitary treatment is not necessary due to the plywood material (ISPM-15)

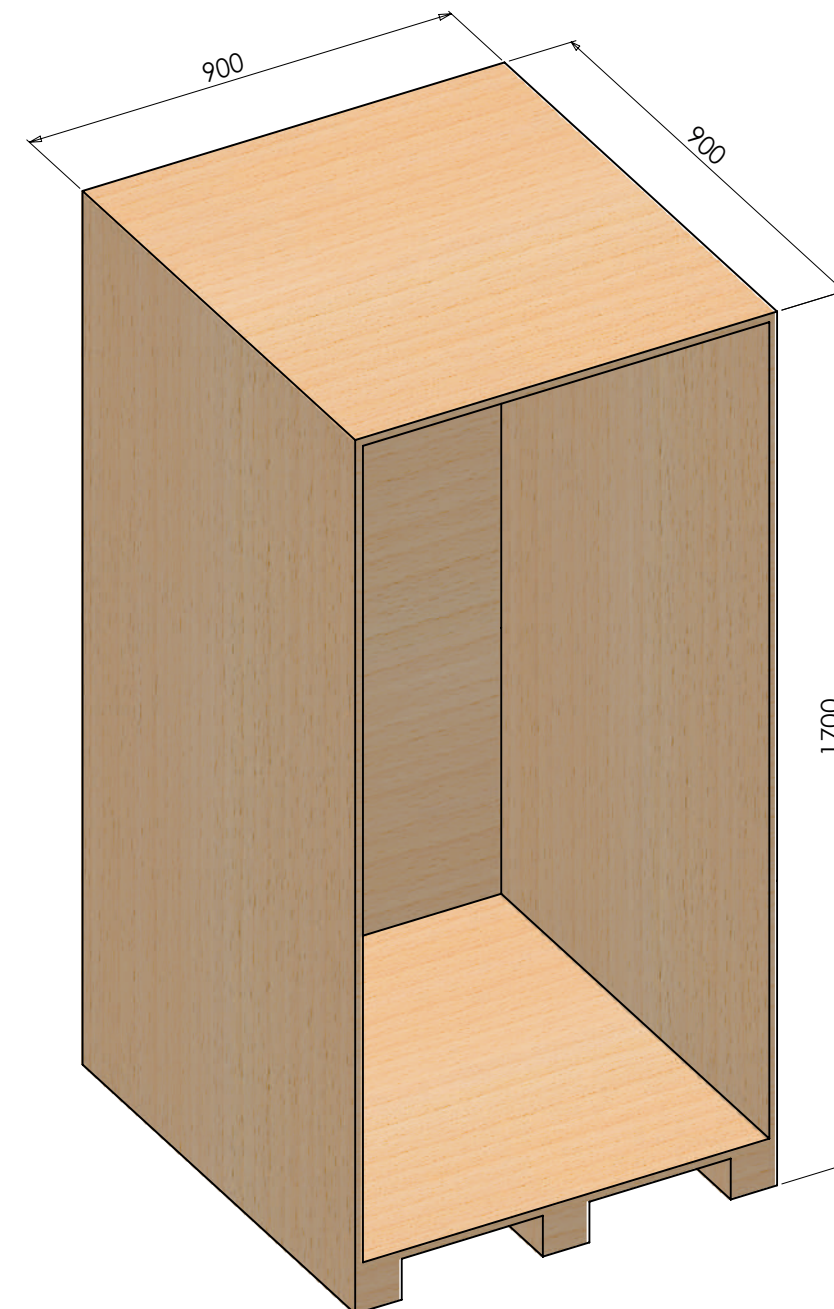



# DISPLAY-46

Bumper demo display

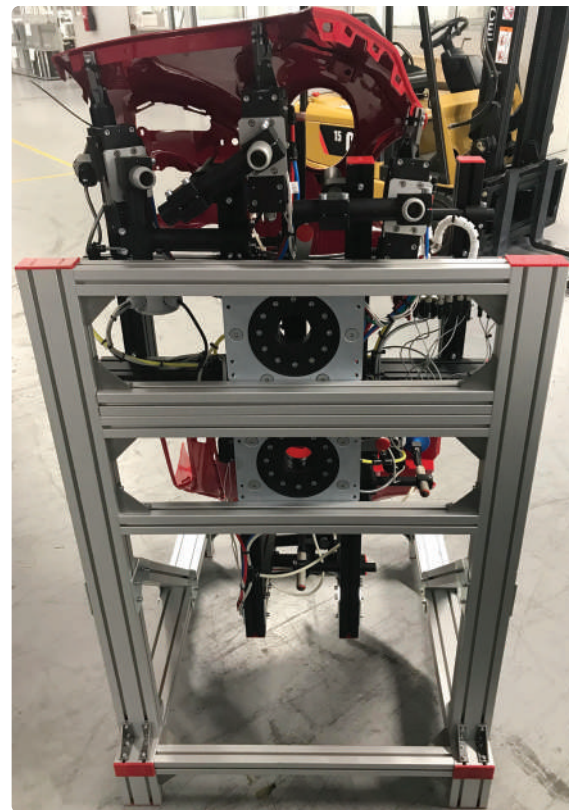
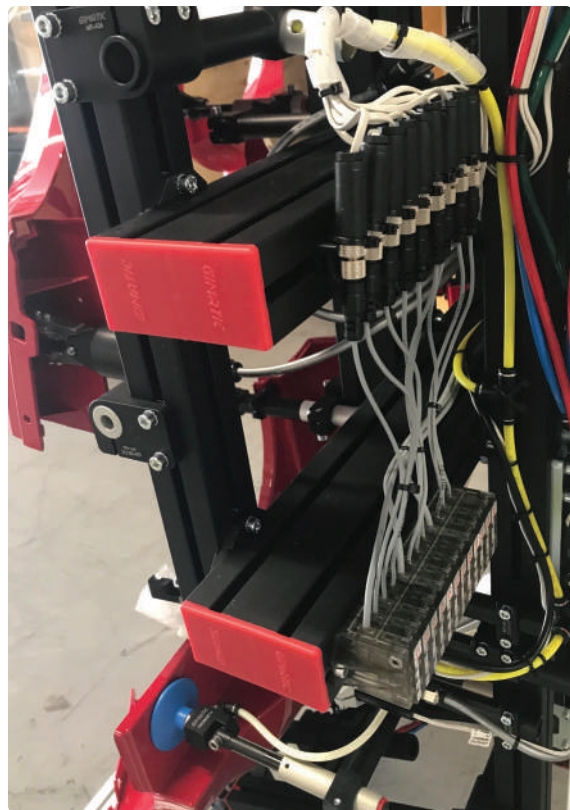
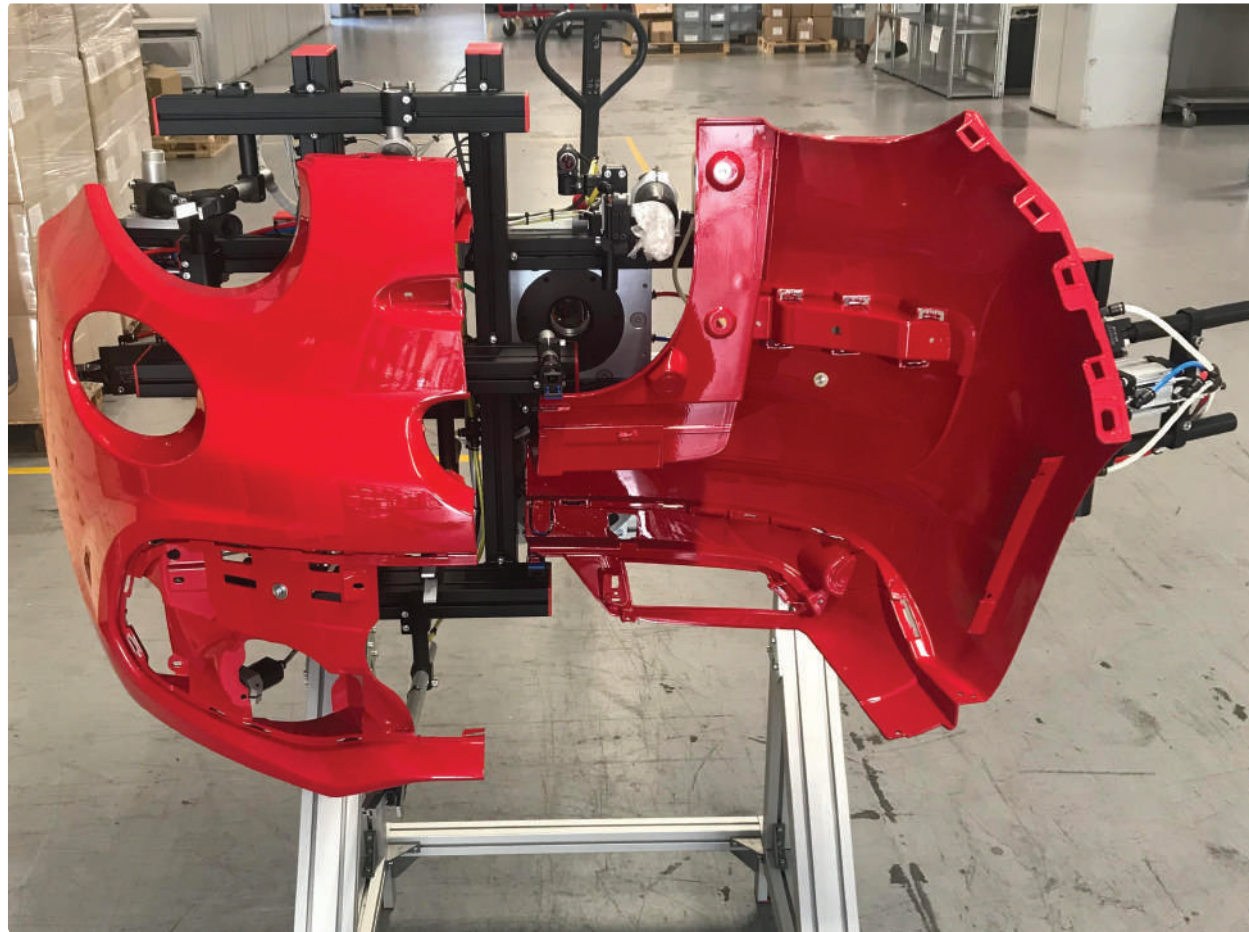

# DISPLAY-48

Display new products Gimatic

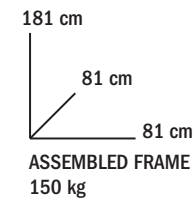

Free for exhibition

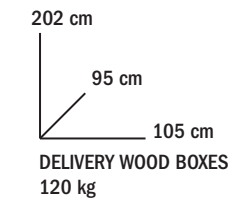

Phytosanitary treatment is not necessary due to the plywood material (ISPM-15)

Power supply	220 Vac
Air Connection	Pipe Ø8

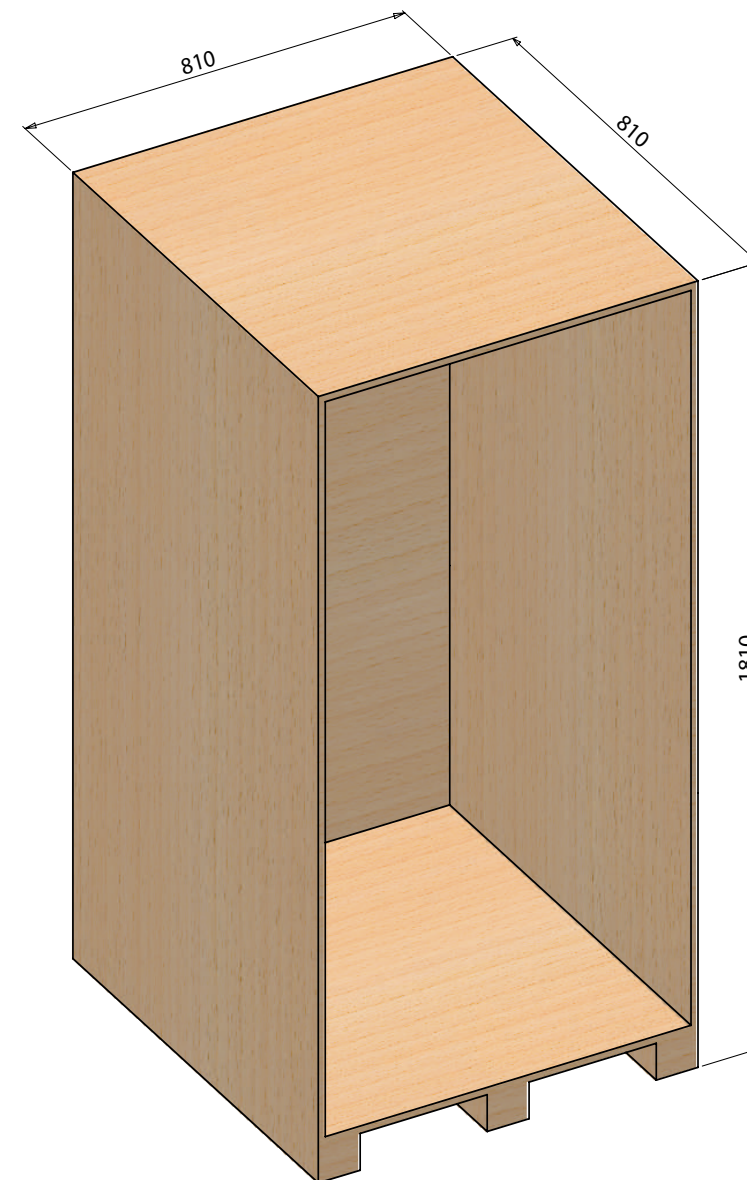



# DISPLAY-48

Display new products Gimatic



SQCP160-B	1
SQCP160-A	1
EQC100-A	1
QC75-A	1
QC75-B	1
EQC100-B	1
ZL16100	1
ZL25100	1
EQC20-A	1
EQC20-B	1
EQC20-K63	1
MFI-A43	1
MFM-A122	1
EQC100-K63	1

OFR20-95G	1
MFI-A252	4
PB-0170	1
MFI-A250	1
OFC14-10	1
MFI-A356	1
MFI-A11	1
MFI-A384	1
MFI-A379	1
OFP14A-25	1
OFP21A-20	1
PT30S	1
PT23N	1
VSNTF2050-NO	1
VAB18M18F-NO	1
VSD2025D10	1
OFN20-90SD	1
OFN30-90SD	1
VS.PFG60SI55N009	1

COJ05	1
COJ12	1
COJ30	1
MCD124	1
MFI-A38	4
GN-20	1
G.N20AE	1
GN-20S	1
G.N20AJ	1
MFI-A39	1
OFE30DX	1
KIT-GMP32	1
KIT-UR-J	1
MPLF3270	1
SGP-32S	1
PQ2012	1
AA-25-NO	1
HS-2518	1
PB0009-S2	1
PB-0007	1
PB-0002	1
PB-0187-S2	1
PB-0180-S2	1
DA20-16E	1
DD20-16M2	1
DD20-16L2	1
OFR20-95-16	1
PB-0170-05	4
PB-0170-02	2
OFR30-95-16F	2
SS4N225-G	4
SSY4N225-G	1

IOLBOX	1
CM12CF12CF8T4	2
CM1200400TERM	1
MLS-CR-G	1
MFI-514	1
MPTM1606IOL	1
MPPM1606IOL	1
QC90-A	2
QC90-B	1
QCA90-A	2
QCA90-B	2
QCP90-B	1
MLD-S001-01	1
SGP-25S	1
SZ16	1
SOQ8M2-G	1
RAQC	1
RBQC	1
MAQC	1
MBQC	1
SU9N2-G	1
SR1C	1
MFI-A118	1
PRO-SN4M225-G	1
PRO-SS4N225-G	1
SBMK	1
SBMM	1
SBMS	3

# DISPLAY-49

robot UR5+RPF

Robot not Included

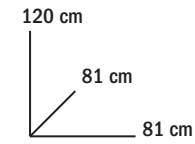

ASSEMBLED FRAME  
150 kg

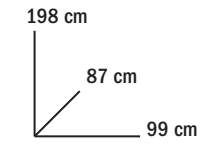

DELIVERY WOOD BOXES  
120 kg

Phytosanitary treatment is not necessary due to the plywood material (ISPM-15)

Free for exhibition

FULL DISPLAY  
€ 2000,00 (in case of buying)

DISPLAY without actuators and cables  
€ 1000,00 (in case of buying)

Power supply	220 Vac
--------------	---------



\*It can be used with UR5 robot too.

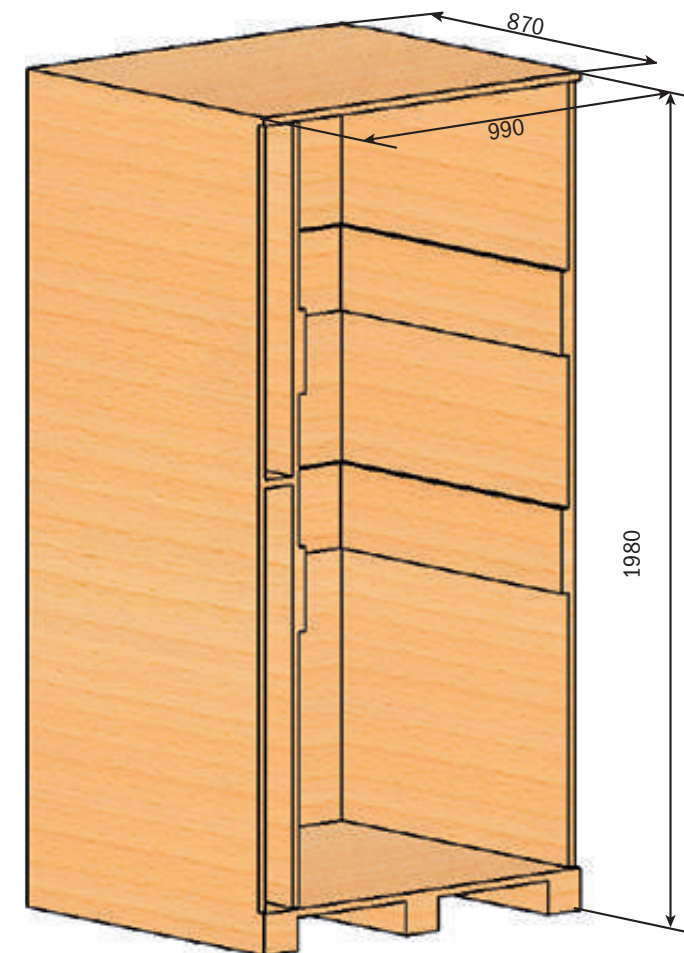



# DISPLAY-51

## EOAT demo display

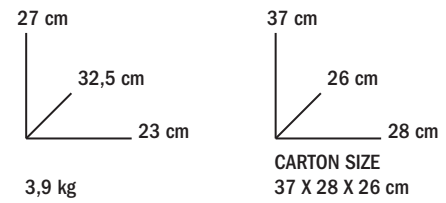

Free for exhibition

FULL DISPLAY  
€ 1000,00 (in case of buying)



MFI-A11	4
MFI-A204	4
VSNF2050-NC	4
VAB18M18F-NO	4
MFI-A379	3
MFI-A239	4
SS3N203-G	4
MBQC	1
RBQC	1
SBMK	1
SBMM	1
SBMS	4
QC90-A	1
RAQCN	1
MAQC	1
VS.PFG50HT160N008	4
AVS.N008G18AG240	4

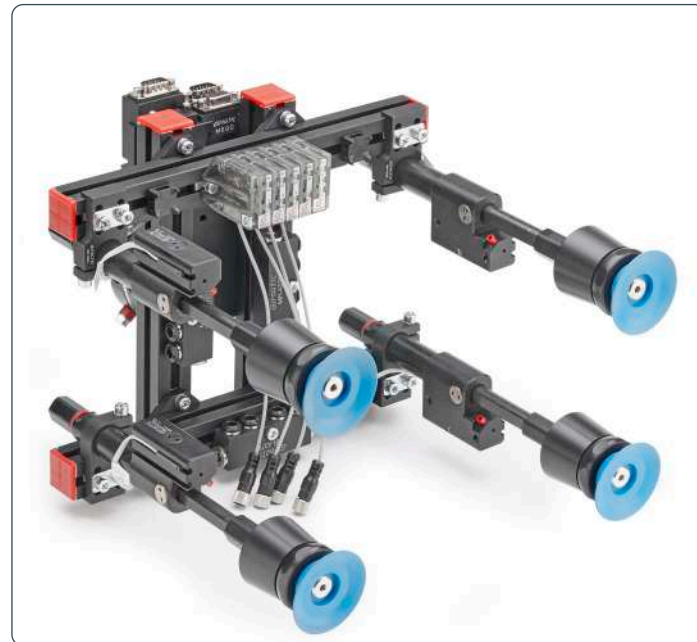

# DISPLAY-50

## Robot Display

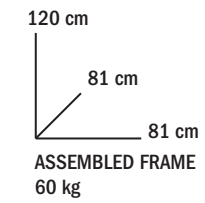

Free for exhibition

FULL DISPLAY  
€ 2000,00 (in case of buying)

DISPLAY without actuators and cables  
€ 1000,00 (in case of buying)

Power supply	220 Vac
Air Connection	pipe Ø8

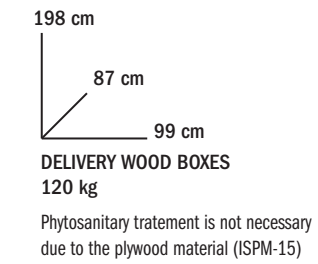

Robot not Included

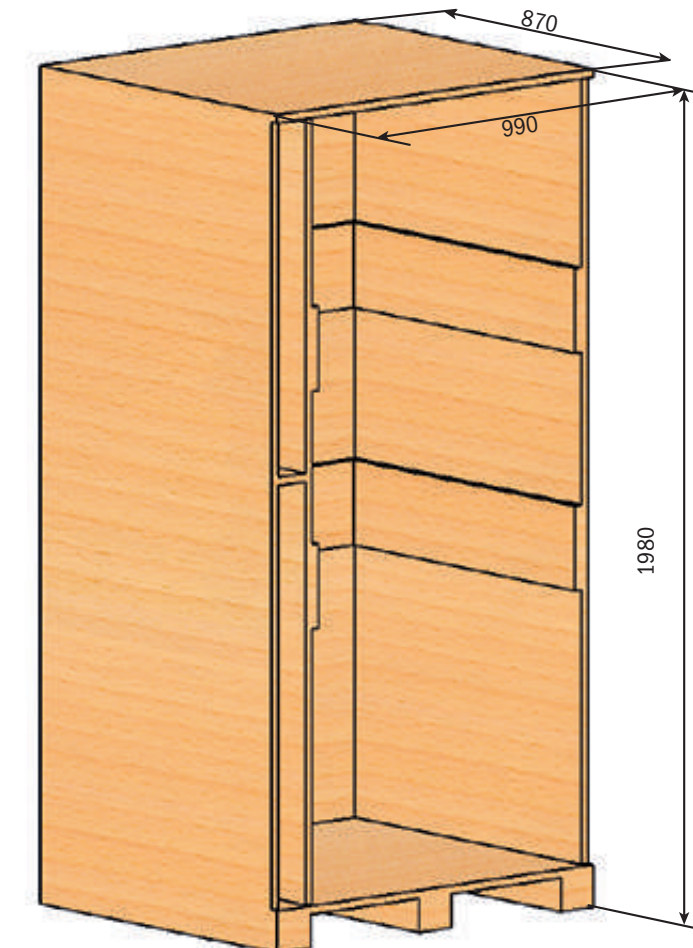

# DISPLAY-50

Mounting parts



# TOOL BOX

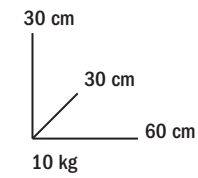

10 kg

Free for exhibition



Fuse 10.3 X 38 500 Vac 2 A	10
Fuse 10.3 X 38 500 Vac 4 A	10
Fuse 10.3 X 38 500 Vac 6 A	10
Air Distributor (MFI-A67)	1
Manual Valve (FEM - FEM 3/8)	1
Digital Multimeter	1
Meter (5 m)	1
Nylon cable ties black 200x2.5mm	100
Insulating tape 25m 15x0.15 mm Black	1
3-pin power strip	1
Extension (220 V)	1
Screwdrivers	5
Wrenches (6-22)	8
Hex Key Sets	1
Rubber mallet with wooden handle	1
Hammer	1
Scissors	1
Tongs	1
Cutter	1
Pipe wrench	1
Pack of Feltre	1

Teflon	1
Biadhesive	1
Scotch tape	1
Paper tape	1
Paper Roll Hands	1
Degreasing	1
Reduction (MAL - MAL 3/8 - 1/4)	1
Reduction (MAL - MAL 1/2 - 3/8)	1
Reduction (MAL - FEM 1/2 - 3/8)	1
Elbows swing (ø 1/4 Tube 8)	2
Elbows swing (ø 3/8 Tube 8)	1
Straight coupling (ø 1/4 Tube 8)	1
Plug 1/4	1
Nipple 1/2	1
Straight male adaptor (ø 1/8 Tube 8)	2
Swiveling elbow male adaptor (ø 1/8 Tube 8)	2
Reducer (ø 1/8 - 1/4)	2
Welder tin	1
Tin roll	1
T connector (ø 8)	10



# START-CASE

8 cm  
32 cm  
45 cm  
10 kg

Free for exhibition  
€ 249,60 (in case of buying)



AV0118M13	4
AV0118M16	4
EMF-2525-0250	2
EMF-2525-0400	2
MFI-A06	4
MFI-A11	4

MFI-A145	4
MFI-A21	1
MFI-A37	4
MFI-A43	1
MFI-A49	4
MFI-A68	1

MFI-A71	4
V0211S01	4
V0233S01	4
VALIGIA-ARTPLAST	1

# SB2T

45 cm  
24.5 cm  
57.5 cm  
1.5 kg

Free for exhibition  
€ 286,00 (in case of buying)



SS4N225-G	2
POWER SUPPLY	1
SG3A2-G	1
SG3N2-G	1
CFGM800325	1
BATTERY	1

# VACUUM-CASE

VACUUM-CASE  
€1.200,00

38 cm  
23 cm  
54 cm  
13 kg



VACUUM-BLISTER-01

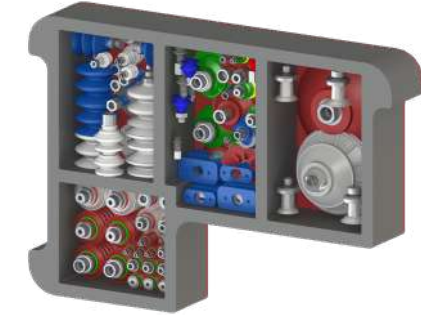

VACUUM-BLISTER-02



## VACUUM-BLISTER-01

3330132	1
3330131	1
VAB18M18F-NO	1
VAQN1820	1
VSRT1025	1
VSRT1010	1
3100028	1
3100029	1
3030125	2

3330061	1
3330075	1
3330057	1
3030132	1
3030139	1
3330088	1
3330086	1
3330119	1
3330130	1

3330094	1
VSNTF2050-NO	1
3300042	1
3300046	1
3300050	1
3300012	2
3030152	1
3030120	1
3330072	1

3330082	1
3330115	1
3330106	2
3300008	2
3300002	2

## VACUUM-BLISTER-02

0000001	1
0000005	1
0000007	1
0000009	1
0000011	1
0000013	1
0321545	2
0321552	2
0321560	2
0321575	2
1010005	2
1011005	2
1020005	2
1510005	2
1511005	2
2010016	2
2021016	2
2321403	2
2321495	2
2321500	2
2321519	2

2321580	2
2321592	2
2321593	2
2321605	2
2321609	2
2321694	1
2321700	2
2321715	2
2321731	2
2321733	2
2321747	2
2321756	4
2321825	2
2321846	2
2321856	2
2321899	2
2321906	2
2321909	2
2321917	1
2321952	3
2321988	1

2322029	1
2322029	1
2322045	1
2322053	4
2322055	4
2322066	2
2322067	2
2322070	4
2322072	4
2322075	2
2322077	2
2322083	2
2322119	2
2322120	2
2322121	2
2322122	2
2322123	2
2322124	2
2322131	2
2322136	2
2322142	2

2322143	2
2322145	2
2322153	1
2322156	1
2322157	1
2322164	1
2322165	2
2322170	2
2510016	2
2511018	2
3100042	1
3100050	1
3100055	1
3510018	2
3511038	2
5210038	2
5221038	2
7521038	1

# HANDLING-MECHA-CASE



**HANDLING-MECHA-CASE**  
Complete demo-case with blisters and products (handling and mechatronics).

€ 3.000,00  
\*Empty case is available, 250 €

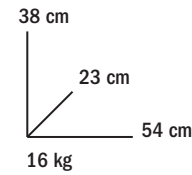

# PLASTICS-CASE

BLISTER 01



BLISTER 02



BLISTER 03

**PLASTICS-CASE**  
€2.000,00  
\* Empty case is available, 250 €

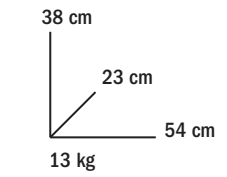

**PLASTICS-BLISTER-01**  
€ 300,00  
2,6 Kg  
47,5 x 32,5 x 4,2 cm  
Empty blister KIT-BLISTER-51-73, 20 €

**PLASTICS-BLISTER-02**  
€ 650,00  
2,4 Kg  
47 x 32,5 x 4,2 cm  
Empty blister KIT-BLISTER-52-73, 20 €

**PLASTICS-BLISTER-03**  
€ 400,00  
4,3 Kg  
45 x 32,5 x 4,4 cm  
Empty blister KIT-BLISTER-53-74, 20 €

\* - VAL: demo sample without internal moving parts



**HANDLING-BLISTER**  
Blister with Handling products.

€ 1.200,00  
Empty blister KIT-BLISTER-71-73, 20 €

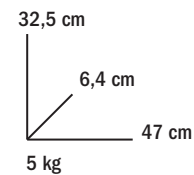

DH2208	1	SS3N203-G	1
TH5404	1	SL3N203-G	1
PQ3015	1	SN3N203-G	1
MGX3210	1	RTD-10	1
SGP-25S	1	CB3N2-G	1
SX4020	1	IFU05S01RT	1
PT25	1	ZE1010P	1
GW-10	1	XP-20	1
TFA14-25	1	PE-1640	1
MFU33E02CL	1	GM-0025	1
Z-0825	1	SZ16	1
GX-16S	1	GS-16	1
MFC33	1	ZA0830	1
RT-10	1	ALLENKEY	1

\* - VAL: demo sample without internal moving parts



**MECHA-BLISTER**  
Blister with Mechatronics products.

€ 1.300,00  
Empty blister KIT-BLISTER-72-74, 20 €

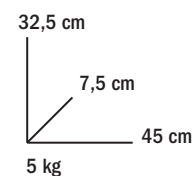

MPPM1606-VAL	1	EQC20-A	1
MPTM1606-VAL	1	EQC20-B	1
MRE16180-VAL	1	CHT10	1
MPRM1690-VAL	1	MPRJ2553	1
MPBM1640-VAL	1	MPLF1630-VAL	1
MPS24-1-S-PNP	1		
ML4070X4-VAL	1		
ML20X10L238-VAL	1		
MPXM1612-VAL	1		
MTRE3204-VAL	1		
SS3N203-G	1		
MPBS1630X-VAL	1		
CFGM2200700	1		

\* - VAL: demo sample without internal moving parts

BLISTER 01

MFI-A329	2	PT23N	2	CAQC	1	RBQC	1
MFI-235	4	MFI-A11	1	CBQC	1	SBMM	1
MFI-A41	1	MFI-A16	1	SBMS	1	SQC100-A	1
MFI-A130	1	MFI-A353	1	SBMK	1	PMAQC	1
MFI-A141	1	QCY90-A	1	RAQC	1	PMBQC	1
MFI-A140	1	QC90-B	1	KIT-ESTRUSI	1	MFI-A372	1
QCA90-A	1	CQC-013	1	QCP50-B	1	VITE-496	6
QCA90-B	1	QC9065	1	SI4N225-G	1		

BLISTER 02

DD20-16P	1	PB-0013	1	WF25040G14	1	VVX1420F	1
VSE2050F18	1	PB-0150	1	OFA20-35	1	VSS2025	1
V0233H04	1	BB-12-NO	1	OFR20-95G	1	VSN1010	1
PAAT16R	1	GS-10	1	DC20-16C	1	VSR1010	1
SZ12	1	GW-10	1	OFX20-10	1	VAM18M18G	1
MFI-A98	1	V0233H04	1	OFD20	1	VSN1420	1
PQ1608	1	AA-35	1	VMK14	1	AV0118F16	1
OFL2010	1	SGP-25S	1	MFI-A260	1	VS.FGA22HT160N016	1
AF10G18M	1	MFI-A98	1	VSE1420F18	1	2011000	1
PB-0170	1	OFC20-20	1	PT28	1		

BLISTER 03

SOQ8N2-G	1	MFI-A02	1	MFI-A66	1	MFU27S01CL	1
AGG19-B	1	MFI-A03	1	MFI-A39	1	GN-05S	1
AGG21-C	1	MFI-A252	1	MFP-A02	1	G.N5AP	1
MFI-A332	1	MFI-A117	1	MFI-A38	1	MFM-A30	2
MFC22	1	MFI-A106	1	MFI-A78	1	ZG-16S-NO	1
MFD22E02CL	1	MFI-A53	1	MFI-A64	1	ZL160	1
GNS-05-NO	1	MFI-A55	1	MFI-A34	1		
MFI-A310	1	MFI-A46	1	MFI-A10	1		
SU9N2-G	1	MFI-A68	1	IFU05S01RT	1		



# CONTACT DOCUMENT

Ask excel version to Gimatic

Messebericht / Fair



vom/date:



Bitte Visitenkarte anheften/ Please pin BC

Bitte schön schreiben! / Please write clearly!

Oder deutlich schreiben + komplette Adresse angeben! / Please fix here the BC or write clearly the address

Name/Name \_\_\_\_\_  
Firma/ Company \_\_\_\_\_  
Position \_\_\_\_\_  
Straße/ Address \_\_\_\_\_  
PLZ/ Cap \_\_\_\_\_  
Land/ Country \_\_\_\_\_  
Tel. \_\_\_\_\_  
Fax \_\_\_\_\_  
E-Mail \_\_\_\_\_  
Webseite/Website \_\_\_\_\_

Messtag / Fair day  
1 2 3  
07.05 08.05 09.05

**Interesse:** bitte ankreuzen/make a x  
 Handling  Greifer/grippers  
 Plastic  Sensoren/sensor  
 Mecha  Kundenspez/ customized  
 Linearmotoren  Carbon  
 Sonstiges/Others  Systeme

Bearbeiter / \_\_\_\_\_  
Who collect the info \_\_\_\_\_  
Eingegeben in CRM/ \_\_\_\_\_  
enter in CRM \_\_\_\_\_  
ProdSpez/ \_\_\_\_\_  
Product Specialist \_\_\_\_\_

**1 Level – Kategorie (deutsch/english)**

- Direktkunde / Direct
- Divers / Various
- Endverbraucher / End User
- Händler / Distributor
- kundenspez. Produkte / Private Label
- OEM Hersteller / OEM Manufacturer
- Wettbewerb / Competitor

**2 Level – Branche (deutsch/english)**

- Montage Autom. allg. / Assembly autom. Equip.
- Blechbearb. Maschinen / Sheet Metal M. Prod.
- Chem. Maschinen / Chemical Machines
- Diverse / Others
- Elektr. Geräte / Electrical Devices
- Elektr. Systeme / Electrical Systems
- Formenbauer / Mould Manufacturer
- Holzmaschinen / Wood Machines
- Konstruktionsbüro / Engineering Office
- Konstruktionsb.Plastic / Engin. Plastic
- Kunststoffspr. / Plastics Inject
- Maschinenbau WZM / Tools Machines
- Mechan. Betrieb / Mechanical Workshop
- Medical/Pharma / Medica /Pharma Mach.
- Produktionsausst. / Prod.
- Rob. Herst. Anw. / Rob. U.
- Schuhmasch. / Shoes
- Sonderm. / Special Machines
- Verpackungsma. / Pack. Mach.
- Zuführ. Handling / Handling-Feeding or Handling-Conveyor

**3 Level - Segmente (deutsch/english)**

- Agrartechnik / Agriculture
- Automotive / Automotive
- Blechverarbeitung / Sheeting
- Chemische Industrie / Chemical
- Elektrische Apparate / Electrical Devices
- Elektrische Systeme / Electrical Systems
- Elektrogeräte / Electrics
- Filter Systeme / Filtration Systems
- Glasverarbeitung / Glasses
- Gummi Herstellung / Rubber Moulding
- Haustechnologie/Building Technology
- Hygiene / Hygiene
- Inmold Labeling / IMM
- Kosmetik & Haushalt / Beauty & Home
- Labor Automation / Lab Automation
- Medical / Medical
- Nahrungsm. & Getr. / Food & Bever.
- Pharma / Pharma
- Polymer Processing / Polymer Proc.
- Reinraum / Clean Room
- Roboter / Robotics
- Rohr Systeme / Pyping Sys.
- Sicherh. Sys. / Security Sys.
- Sonstiges / Others
- Spielwaren / Toys
- Spritzgußformen / Moulding
- Textil / Textile
- Vakuum / Vacuum
- Verpackung / Packaging
- Weißware / Home App.

Potential:  null/no  gering/low  mittel/medium  hoch/high

# CONTACT DOCUMENT

Ask excel version to Gimatic

Messebericht / Fair



vom/date:



Informationsunterlagen (bitte ankreuzen): / Document needed (please make a x):  
erhalten/ zusenden/ship erhalten zusenden

- |   |                          |                          |  |                          |                          |
|---|--------------------------|--------------------------|--|--------------------------|--------------------------|
| <input type="checkbox"/> Cat.Handling       | <input type="checkbox"/> | <input type="checkbox"/> | <input type="checkbox"/> Flyer Handling      | <input type="checkbox"/> | <input type="checkbox"/> |
| <input type="checkbox"/> Cat. Plastic       | <input type="checkbox"/> | <input type="checkbox"/> | <input type="checkbox"/> Flyer Plastic       | <input type="checkbox"/> | <input type="checkbox"/> |
| <input type="checkbox"/> Sensoren/ Sensors  | <input type="checkbox"/> | <input type="checkbox"/> | <input type="checkbox"/> CD Plastik/Handling | <input type="checkbox"/> | <input type="checkbox"/> |
| <input type="checkbox"/> PDF Mechatr./Flyer | <input type="checkbox"/> | <input type="checkbox"/> |  |                          |                          |

... und wie geht's weiter:/ what's the costumer needs after the fair **Bis wann?/ When?**  
– bitte ankreuzen/ please check – bitte Datum eingeben/ write a date

- telefonische Kontaktaufnahme/ telephone contact
- Besuch/ visit
- Angebot/ offer

**Gesprächsinhalt:/ Interview:**

- Skizze Rückseite
- Draw on the back site

.....

.....

.....

.....

.....

.....

.....

.....

.....

.....

.....

.....

.....

.....

.....

.....

.....

.....

.....

.....

# EXHIBITION BOOTH EXAMPLES

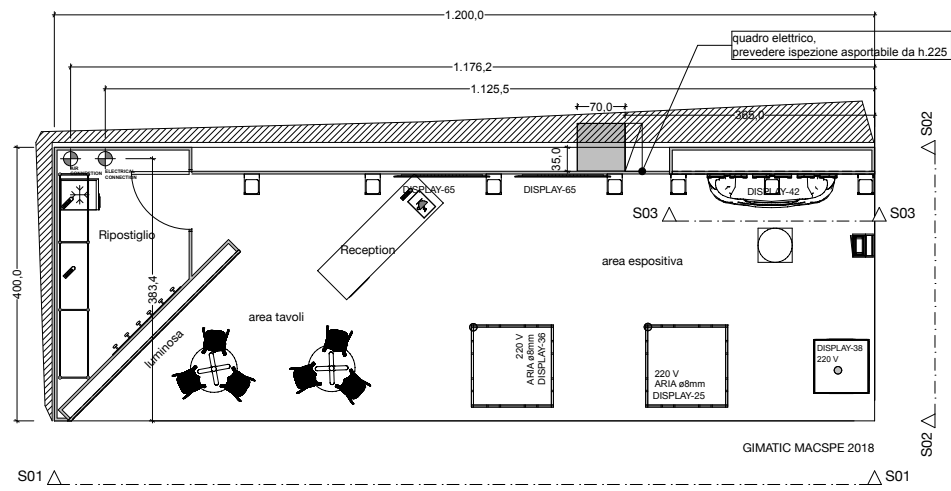

# EXHIBITION REPORT

Ask excel version to Gimatic

## EXHIBITION

Name	
WebSite	
Date (dd/mm/yy)	
Days (n°)	
Country	
Type (Plastics; Handling; Mecha; Sensors)	
N° visitors (Previous Edition)	
N° expositors (Previous Edition)	
Hold by	
Note	

## CONTACTS

N° of contacts all exhibition	
N° of contacts per day	
N° of new contacts	
Nationality	
Type of customer (Direct, EndUser, Distributors, ...)	
Main segments	
Main interest (Plastics, Handling, Mecha, Sensors)	
Sales and technical main request	
Main competitors	
Note	

## COSTS

€/space	
€/stand	
€/delivery	
€/fees	
€/people	
€/services	
€/exhibition advertaising	
€/Total costs	
Note	





# EXHIBITION REPORT

## BOOTH

Construction manufacturer	
Square meters booth	
Positioning	
Dimension	
Facilities	
Lighting	
General layout	
Note	

## DEMO MATERIAL

Catalogue	
Brochure	
Demo static display (DISPLAY-...)	
Demo dynamic display (DISPLAY-...)	
Demo static display (PAN-...)	
Gimatic bags	
Gimatic pens	
USB	
CD-ROM	
Others...	
Note	

## NEXT YEAR EXHIBITION

Name	
Note	

Write by	
Date	
Final Note	

# PAPER MARKETING

## COVER STORY (Examples)



## INTERNAL ADVERTISE (Examples)

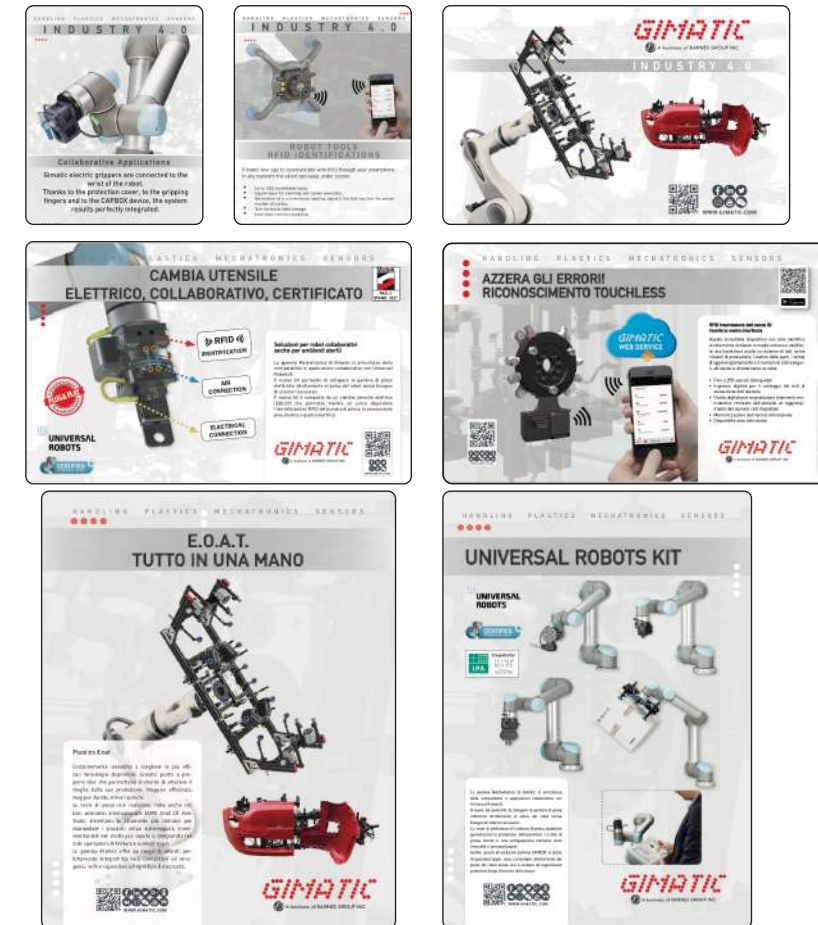

## CASE HISTORY (Examples)



## EDITORIAL (Examples)





# PAPER MARKETING CHECK LIST

Our goal is to define the best successful points for succesful advertaising campaign:

- Have you defined best techical magaziene for our Market in your area?
- Have you found any of our competitors on these magazines?
- Have you checked how many copies they print?
- Have you checked how many release they do during a year?
- Have you checked if their publishing house provide different trade magazines?
- Have you get best offer for your advertaising campain?
- Have you defined best Month to make advertaise (better previous or the same as exhibition)?
- Have you asked Gimatic to provide you advertaise template (cover, internal magazine, ...)?
- Have you asked Gimatic to provide you editorial about our newest products?
- Have you asked or shared with Gimatic succesful case history?

# PAPER MARKETING PLAN

Ask excel version to Gimatic



ADVERTISING PLAN (rev.2015-01)	
<b>PAPER MARKETING</b>	
Trade Magazine	
Publishing house	
Type of magazine (H;P;M;S)	
n°copies	
Yearly release	
Competitors on this Trade magazine	
<b>GIMATIC PAPER RELEASE</b>	
Month release	
Type of release (cover, editorial, internal adv..)	
Subject of release (ask Gimatic material)	
Main Language of release	
Free option web release (case history, editorial..)	
€/release	
€/people (external adv. service)	
<b>€/Total costs</b>	
<b>€/TOTAL ADVERTAISING COSTS</b>	
<b>DATE</b>	
<b>WRITTEN BY</b>	
<b>NOTE</b>	

# WEB MARKETING SOCIAL



These are our current social networks:

- Facebook
- LinkedIn
- Twitter
- Instagram
- Youtube

Follow us on social networks and share the latest news.

# PORTALS



A portal that shows our products and where the customers can make they requests.

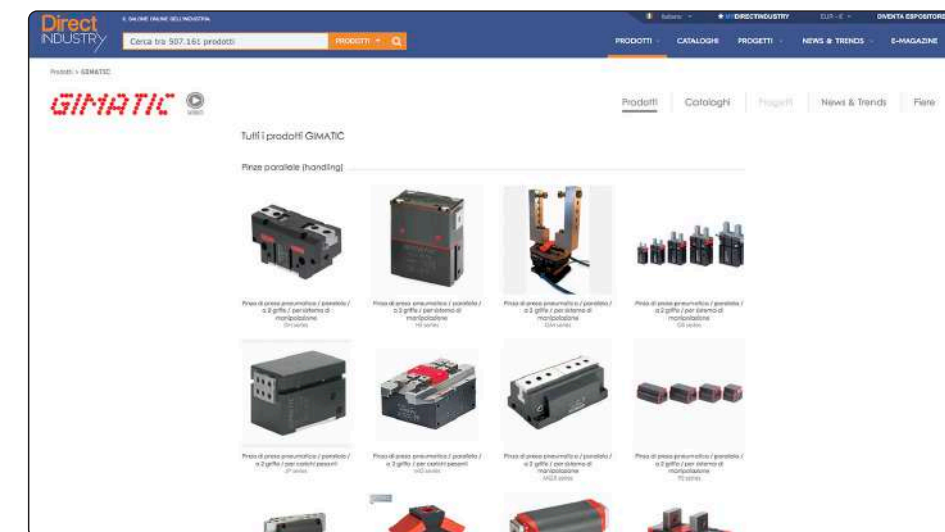

# WEB MARKETING CHECK LIST

**Our goal is to define the best succesful points for succesful advertaising campaign:**

- Have you defined best techical web portal for our Market in your area?
- Have you found any of our competitors on these web portal?
- Have you get best offer for your banner advertaising campain?
- Have you defined best Month to make banner advertaise (around as exhibition)?
- Have you checked if they provide mailing?
- How many contact leeds they can reach by e-mail?
- Have you asked Gimatic to provide you Banner advertaise template?
- Have you asked Gimatic to provide you editorial about our newest products?
- Have you asked or shared with Gimatic succesful case history?

# WEB MARKETING PLAN

Ask excel version to Gimatic

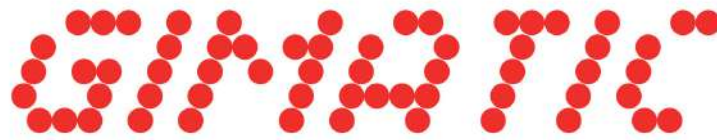

 A business of BARNES GROUP INC

ADVERTAISING PLAN (rev.2014-12)	
<b>WEB MARKETING</b>	
Web Portal	
Website	
Type of web portal (H;P;M;S)	
Ranking	
Yearly release	
Competitors on this Web Portal	
<b>GIMATIC WEB RELEASE</b>	
Month release	
Type of release (banner, editorial, web shop..)	
Subject of release (ask Gimatic material)	
Main Language of release	
Free option web release (case history, editorial..)	
€/web release	
€/people (external adv. service)	
<b>€/Total costs</b>	
<b>€/TOTAL ADVERTAISING COSTS</b>	
<b>DATE</b>	
<b>WRITTEN BY</b>	
<b>NOTE</b>	





Via Enzo Ferrari, 2/4  
25030 Roncadelle (BS) ITALY  
tel. +39 030 2584655  
fax +39 030 2583886  
info@gimatic.com  
www.gimatic.com