



Metasol

Meta Solution

Contactors and Overload relays



Metasol Contactors and Overload Relays

*New generation of Contactors
from LS Industrial Systems*



Metasol Contactors

Metasol Contactors

■ **Designed to show superior technology:
The Metasol series**

Sealed structure has improved its safety features so that no arc flash is exposed. In order to emphasize its durability as an industrial device, Metasol series adopt simple design form and sophisticated shape applying diamond cut concepts on product surface.



LSIS META SOLUTION CONTACTORS

Contents :



Metasol MC

Table of specifications	10
Type numbering system	12
Environment	16
Connections	17
Control coil characteristics	18
Marking	20
Internal structure	21
Contactors (18~800AF)	22
Motor starters	40
Reversing contactors	44
Capacitive contactors	46
Accessory	48
Overload relays	58
Overload relay trip curves	74
Type 2 Coordination	82
Rated short circuit breaking capacity of installation	85
Dimension	86
Contact arrangement	104

Mini Contactor

EMPR

Manual Motor Starters

Catalogue numbers

.....	107
.....	141
.....	154
.....	170

Metasol Series completion

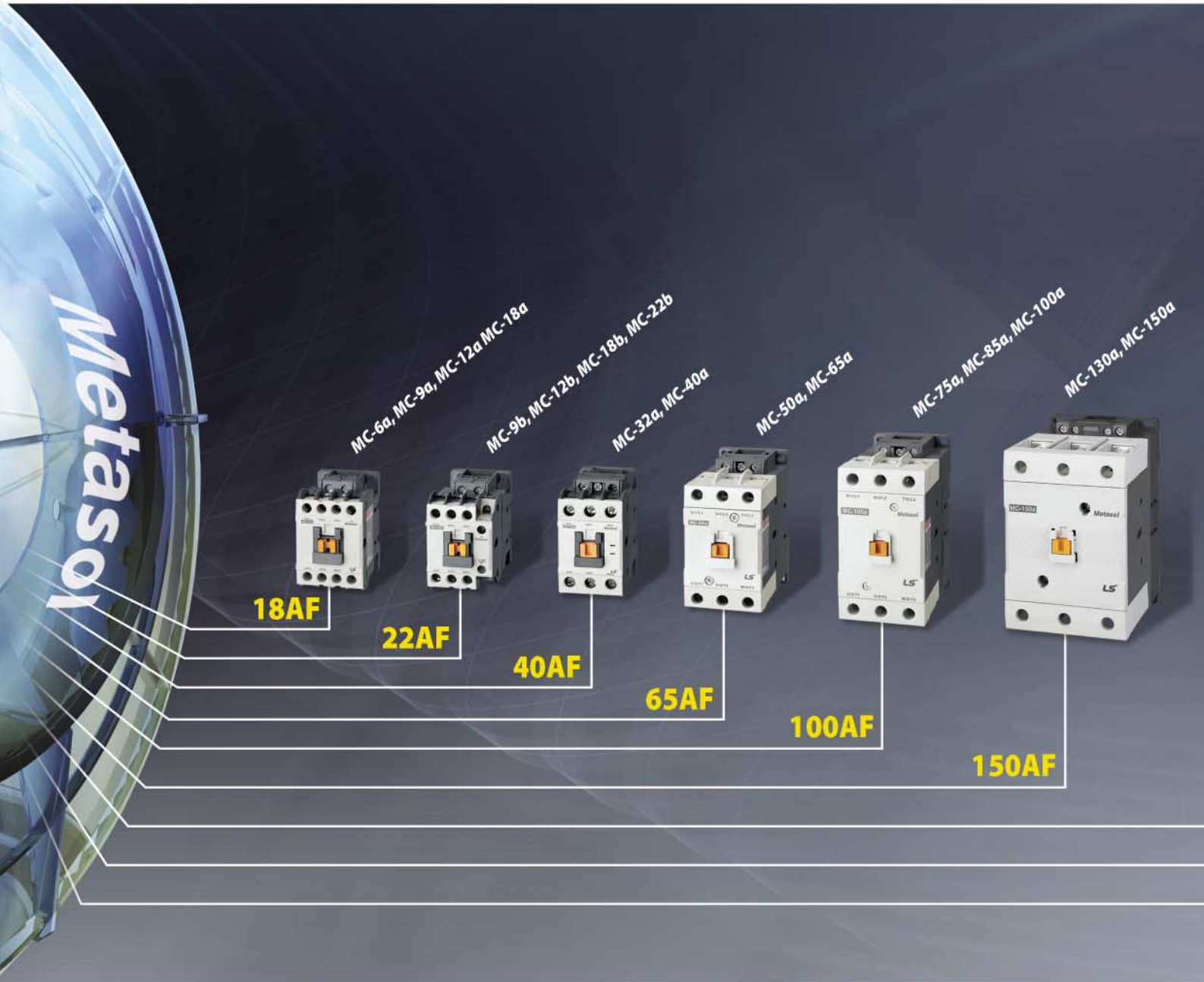

More Safe,
More Valuable



Contactors & Overload Relays



- *Advanced technology & Expert solution*
- *Offering economical solution with compact size & easy connection*
- *Ensure reliability in the system: Type II Coordination*
- *Perfect system with peripheral devices.*
- *Environment friendly product: complies with International environment standard RoHS.*
- *25 Models in 9 Frames*



MC/TOR

25 Models in 9 Frames

High reliability from optimum design

Metasol

Meta solution

- Compact design for space saving
- DIN rail and screw mountable
- Directly mountable overload relays provided separately
- Easy to combine with manual motor starters by using adapter and wiring kit
- Finger-proof design
- Broad range of accessories
- World class products conforming to IEC and UL standards

18AF

Contactor
MC-6a, 9a, 12a, 18a
 Rated current: 6, 9, 12, 18A
 Rated insulation voltage: 690V
 Type II : 150kA @415V Max.

Overload relay MT-12
 Current range: 0.1~18A
 Trip class: Class10, 20



22AF

Contactor
MC-9b, 12b, 18b, 22b
 Rated current: 9, 12, 18, 22A
 Rated insulation voltage: 690V
 Type II : 150kA @415V Max.

Overload relay MT-32
 Current range: 0.1~40A
 Trip class: Class10, 20



800AF

Contactor

MC-500a, 630a, 800a

Rated current: 500, 630, 800A
Rated insulation voltage: 690V
Type II : 150kA @415V Max.

Overload relay MT-800

Current range: 200~800A
Trip class: Class10, 20



400AF

Contactor

MC-265a, 330a, 400a

Rated current: 265, 330, 400A
Rated insulation voltage: 690V
Type II : 150kA @415V Max.

Overload relay MT-400

Current range: 85~400A
Trip class: Class10, 20



225AF

Contactor

MC-185a, 225a

Rated current: 185, 225A
Rated insulation voltage: 690V
Type II : 150kA @415V Max.

Overload relay MT-225

Current range: 65~240A
Trip class: Class10, 20



40AF

Contactor

MC-32a, 40a

Rated current: 32, 40A
Rated insulation voltage: 690V
Type II : 150kA @415V Max.

Overload relay MT-32

Current range: 0.1~40A
Trip class: Class10, 20



65AF

Contactor

MC-50a, 65a

Rated current: 50, 65A
Rated insulation voltage: 690V
Type II : 150kA @415V Max.

Overload relay MT-63

Current range: 4~65A
Trip class: Class10, 20



100AF

Contactor

MC-75a, 85a, 100a

Rated current: 75, 85, 100A
Rated insulation voltage: 690V
Type II : 150kA @415V Max.

Overload relay MT-95

Current range: 7~100A
Trip class: Class10, 20



150AF

Contactor

MC-130a, 150a

Rated current: 120, 150A
Rated insulation voltage: 690V
Type II : 150kA @415V Max.

Overload relay MT-150

Current range: 34~150A
Trip class: Class10, 20





MC/TOR Accessories

Perfect combination of peripheral
devices and various accessories

Offering economical solution with compact size & easy connection



Perfect system with other devices and accessories

■ One-touch connection

- Din Rail connection without any special tools
- Direct combine a surge unit

■ Simple wiring

- Mounting unit, Adapter
- Reversing wire set

■ Easy Maintenance

- 4-terminal type: Easy wiring of operation coil
- Module type of Screw terminal
- Interlock unit with built-in auxiliary contacts(2NO built-in)

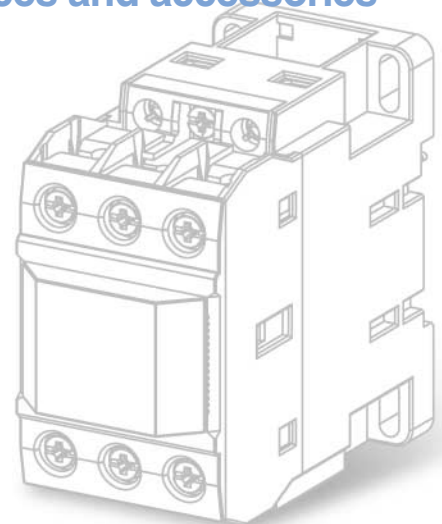

Advanced accessories for Metasol contactors

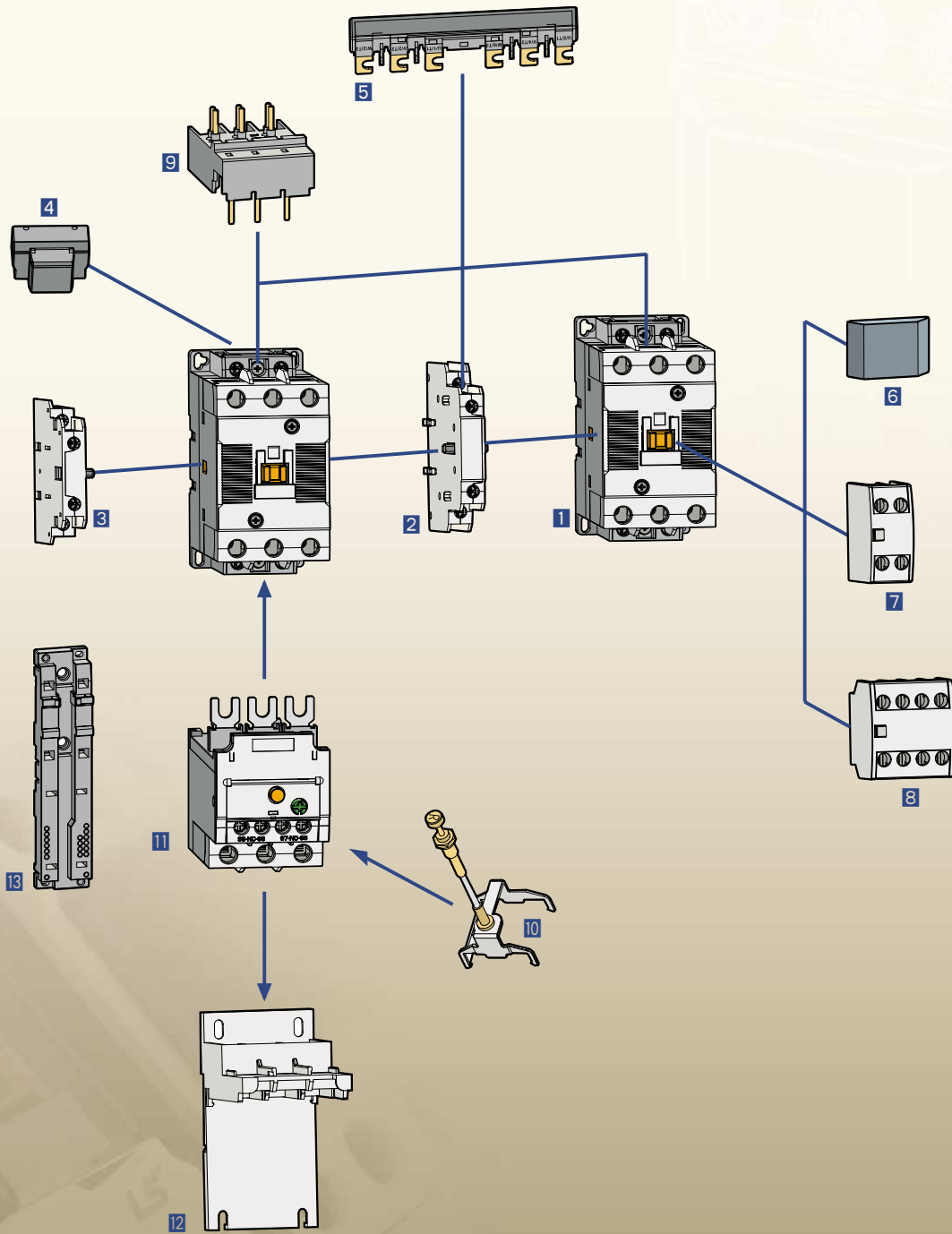

Accessory layout upto 150AF

- | | | |
|---|--|--|
| 1 Contactor | 6 Safety cover (Option) | 10 Remote reset unit |
| 2 Interlock unit | 7 Auxiliary contact unit
- front mount(2p) | 11 Overload relay |
| 3 Auxiliary contact unit
- side mount | 8 Auxiliary contact unit
- front mount(4p) | 12 Separate mounting unit |
| 4 Surge unit | 9 Direct adaptor to MMS | 13 Mounting unit for use with MMS |
| 5 Wire kit | | |

Table of specifications

MC type Magnetic Contactors



Frame size			18AF				22AF				
Type	screws clamp terminals		MC-6a	MC-9a	MC-12a	MC-18a	MC-9b	MC-12b	MC-18b	MC-22b*	
Number of poles			3pole				3pole				
Rated operational voltage, Ue			690V				690V				
Rated insulation voltage, Ui			690V				690V				
Rated frequency			50/60Hz				50/60Hz				
Rated impulse withstand voltage, Uimp			6kV				6kV				
Maximum operating rate in operating cycles per hour(AC3)			1800 operations per hour				1800 operations per hour				
Durability	Mechanical		15 mil. operations				15 mil. operations				
	Electrical		2.5 mil. operations				2.5 mil. operations				
Current and power	AC-1, Thermal current	A	25	25	25	32	25	25	32	40	
		AC-3	200/240V	kW	2.2	2.5	3.5	4.5	2.5	3.5	4.5
			A	9	11	13	18	11	13	18	22
		380/440V	kW	3	4	5.5	7.5	4	5.5	7.5	11
			A	7	9	12	18	9	12	18	22
		500/550V	kW	3	4	7.5	7.5	4	7.5	7.5	15
			A	6	7	12	13	7	12	13	20
		690V	kW	3	4	7.5	7.5	4	7.5	7.5	15
		A	4	5	9	9	6	9	9	18	
UL rating (50/60Hz)	Continuous current		A	25	25	25	32	25	25	40	40
	Single phase	110~120V	HP	0.5	0.5	0.75	1	0.5	0.75	1	2
		220~240V	HP	1.5	1.5	2	3	1.5	2	3	3
	Three phase	200~208V	HP	2	2	3	5	2	3	5	7.5
		220~240V	HP	3	3	5	7.5	3	5	7.5	10
		440~480V	HP	5	5	7.5	10	5	7.5	10	15
		550~600V	HP	7.5	7.5	10	15	7.5	10	15	20
NEMA size			00	00	0	0	00	00	0	1	
Size and weight	AC control	Weight	0.33				0.34				
		Size(W × H × D) mm	45 × 73.5 × 82				45 × 73.5 × 86				
	DC control	Weight	0.5				0.51				
		Size(W × H × D) mm	45 × 83 × 113.7				45 × 73.5 × 117.7				
Auxiliary(standard)			1a or 1b				1a1b				
Auxiliary	Side mount		UA-1				UA-1				
	Front mount		AU-2, AU-4				AU-2, AU-4				

Note) Minimum conduct current of Auxiliary contactor is DC 17V 5mA.

MT type Thermal Overload Relays



Type	Screws clamp terminals		MT-12/□		MT-32/□	
Rated operational voltage, Ue			690V		690V	
Rated insulation voltage, Ui			690V		690V	
Rated impulse withstand voltage, Uimp			6kV		6kV	
Trip class			10A, 20		10A, 20	
Setting range			0.1~18A		0.1~40A	
Size and weight	Weight	kg	0.1		0.17	
		Size(W × H × D) mm	45 × 73.2 × 63.7		45 × 75 × 90	

* The safety cover of magnetic contactor and thermal overload relay is optional.



40AF	
MC-32a	MC-40a
●	●
3pole	
690V	
1000V	
50/60Hz	
8kV	
1800 operations per hour	
12 mil. operations	
2 mil. operations	
50	60
7.5	11
32	40
15	18.5
32	40
18.5	22
28	32
18.5	22
20	23
50	60
2	3
5	7.5
7.5	15
10	15
20	30
25	30
1	1
0.55	
69 × 83 × 93	
0.77	
69 × 83 × 120	
UA-1	
AU-2, AU-4	



MT-32/□
●
690V
690V
6kV
10A, 20
0.1~40A
0.17
45 × 75 × 90



65AF	
MC-50a	MC-65a
●	●
3pole	
690V	
1000V	
50/60Hz	
8kV	
1800 operations per hour	
12 mil. operations	
2 mil. operations	
70	100
15	18.5
55	65
22	30
50	65
30	33
43	60
30	33
28	35
70	100
3	5
10	15
20	25
25	30
40	50
50	60
2	2
1.05	
79 × 106 × 122	
1.3	
79 × 106 × 149	
UA-1	
AU-2, AU-4	



MT-63/□
●
690V
690V
6kV
10A, 20
4~65A
0.31/0.33
55 × 81 × 100



100AF		
MC-75a	MC-85a	MC-100a
●	●	●
3pole		
690V		
1000V		
50/60Hz		
8kV		
1800 operations per hour		
12 mil. operations		
2 mil. operations		
110	135	160
22	25	30
75	85	105
37	45	55
75	85	105
37	45	55
64	75	85
37	45	45
42	45	65
110	135	160
5	7.5	10
15	15	20
25	30	30
30	40	40
50	60	75
60	75	75
2	3	3
1.93		
94 × 140 × 137		
2.8		
94 × 140 × 174		
UA-1		
AU-2, AU-4		



MT-95/□
●
690V
690V
6kV
10A, 20
7~100A
0.48/0.5
70 × 97 × 110

Table of specifications

MC type Magnetic Contactors



Frame size			150AF		225AF		
Type	screws clamp terminals		MC-130a	MC-150a	MC-185a	MC-225a	
Number of poles			3pole		3pole		
Rated operational voltage, Ue			690V		690V		
Rated insulation voltage, Ui			1000V		1000V		
Rated frequency			50/60Hz		50/60Hz		
Rated impulse withstand voltage, Uimp			8kV		8kV		
Maximum operating rate in operating cycles per hour(AC3)			1200 operations per hour		1200 operations per hour		
Durability	Mechanical		5 mil. operations		5 mil. operations		
	Electrical		1 mil. operations		1 mil. operations		
Current and power	AC-1, Thermal current	A	160	210	230	275	
	AC-3	200/240V kW	37	45	55	75	
		A	130	150	185	225	
		380/440V kW	60	75	90	132	
		A	130	150	185	225	
		500/550V kW	60	70	110	132	
	A	90	100	180	200		
	690V kW	55	55	110	140		
	A	60	60	120	150		
UL rating (50/60Hz)	Continuous current		160	210	230	275	
	Single phase	110~120V	HP	10	15	15	15
		220~240V	HP	20	25	30	40
	Three phase	200~208V	HP	40	40	60	60
		220~240V	HP	40	50	60	75
		440~480V	HP	75	100	125	150
	550~600V	HP	75	75	125	150	
	NEMA size		3	4	4	4	
Size and weight	AC control	Weight kg	2.4		5.4		
	DC control	Weight kg	2.3		138 × 203 × 181		
	Size(W × H × D) mm		95 × 158 × 132				
	Size(W × H × D) mm		95 × 158 × 132				
Auxiliary(standard)					2a2b		
Auxiliary	Side mount		UA-1		AU-100 (Max.4NO4NC)		
	Front mount		AU-2, AU-4		-		

MT type Thermal Overload Relays



Type			MT-150/□	MT-225/□
Screws clamp terminals			●	●
Rated operational voltage, Ue			690V	690V
Rated insulation voltage, Ui			690V	690V
Rated impulse withstand voltage, Uimp			6kV	6kV
Trip class			10A, 20	10A, 20
Setting range			34~150A	65~240A
Size and weight	Weight	kg	0.67	2.5
	Size(W × H × D) mm		95 × 109 × 113	147 × 141 × 184

* The safety cover of magnetic contactor and thermal overload relay is optional.



400AF

MC-265a	MC-330a	MC-400a
●	●	●
3pole		
690V		
1000V		
50/60Hz		
8kV		
1200 operations per hour		
5 mil. operations		2.5 mil. operations
1 mil. operations		0.5 mil. operations
300	350	450
80	90	125
265	330	400
147	160	200
265	330	400
147	160	225
225	280	350
160	200	250
185	225	300
300	350	450
-	-	-
-	-	-
75	100	125
100	125	150
200	250	300
200	250	300
5	5	5

9.2
163 × 243 × 198

2a2b

AU-100 (Max.4NO4NC)



MT-400/□

●

690V

690V

6kV

10A, 20

85~400A

2.6

151 × 171 × 198



800AF

MC-500a	MC-630a	MC-800a
●	●	●
3pole		
690V		
1000V		
50/60Hz		
8kV		
1200 operations per hour		
2.5 mil. operations		0.5 mil. operations
580	660	900
147	190	220
500	630	800
265	330	440
500	630	800
265	330	500
400	500	720
300	400	500
380	420	630
580	660	900
-	-	-
-	-	-
150	200	200
200	250	300
400	500	600
400	500	600
6	6	7

22.4
285 × 312 × 242

2a2b

AU-100 (Max.4NO4NC)



MT-800/□

●

690V

690V

6kV

10A, 20

200~800A

11.5

360 × 530 × 212

Type numbering system

Contactors

MC-6a / **R** / **AC220** **60Hz** **1a1b**

Rated current		Version		Coil voltage		Frequency		Auxiliary contact	
6a	6A	-	Standard	AC 220	AC 220V	60	60Hz	00	None
⋮	⋮	R	Reversing	⋮	⋮	50	50Hz	11	1a1b
800a	800A			DC 24	DC 24V			22	2a2b
								10	1a(1NO)
								01	1b(1NC)

Note) See page 18, 19 for details.

Starters

MS-6a / **R** **2H** / **AC220** **60Hz** **10** / **0.1**

Rated current		Contactor version		Relay version		Coil voltage		Frequency		Auxiliary contact		Relay setting current	
6a	6A	-	Standard	2H	Non-differential (2-heater)	AC 220	AC 220V	60	60Hz	00	None	0.1	0.1A
⋮	⋮	R	Reversing	3H	Non-differential (3-heater)	⋮	⋮	50	50Hz	11	1a1b	⋮	⋮
800a	800A			3K	Differential	DC 24	DC 24V			22	2a2b	800	800A
				3D	Class 20					10	1a(1NO)		
										01	1b(1NC)		

Note) See page 18, 19 for details.

Thermal Overload Relay

MT-12 / **2H** **0.1**

Frame size		Relay version		Relay setting current	
12	12AF	2H	Non-differential (2-heater)	0.1	0.1A
32	32AF	3H	Non-differential (3-heater)	⋮	⋮
63	63AF	3K	Differential	800	800A
95	95AF	3D	Class 20		
⋮	⋮				
800	800AF				

Optional Accessories

Auxiliary contact unit

UA1

11

Version	
UA-1	Side mount
AU-100	
AU-2	Front mount(2P)
AU-4	Front mount(4P)

Contact composition	
11	1NO+1NC
20	2NO
02	2NC
40	4NO
31	3NO+1NC
22	2NO+2NC
13	1NO+3NC
04	4NC

Surge absorber

US11

Composition and voltage		
1	Varistor+RC	AC/DC 24~48V
2	Varistor+RC	AC/DC 100~125V
3	Varistor+RC	AC/DC 200~240V
4	Varistor+RC	AC 380~440V
5	Varistor+RC	AC 24~48V
6	Varistor+RC	AC 100~125V
11	Varistor	AC 200~240V
12	Varistor	DC 24~48V
13	Varistor	DC 100~125V
14	Varistor	DC 200~220V
22	RC	AC 100~125V

Note) See page 52 for details.

Interlock unit

UR02

Contact composition	
02	2NC
00	None

Wire kit for Interlocking

UW32

Frame size	
18	18AF
22	22AF
32	32AF
63	63AF
95	95AF

Interlock set (UR+UW)

RK32

Frame size	
32	32AF
63	63AF
95	95AF

Separate mounting unit (For relay)

UZ32

Frame size	
32	32AF
63	63AF
95	95AF
150	150AF

Remote reset unit (For relay)

UM

Cable length	
4R	400
5R	500
6R	600



















Environment



Standards	IEC/EN 60947-1, IEC/EN 60947-4-1, UL508, K60947
Certifications	CE, UL
Rated insulation voltage (Ui)	1000V
Rated impulse withstand voltage (Uimp)	8kV
Degree of protection	IP20 (Conforming to IEC60529)
Ambient air temperature	Storage: -50° C ~ +80° C
	Operation: -5° C ~ +60° C
Operating altitude	3000m (8900ft)
Operating positions	
Shock resistance (1/2 sine wave =11ms)	Opened: 8G
	Closed: 10G
Vibration resistance (Conforming to IEC68-2-6) (5...300 Hz)	Opened: 2G
	Closed: 4G
Flame resistance	Conforming to UL 94: Vo
	Conforming to IEC 695-2-1: 960° C

Connections

Connections

Wire type									Torque
		(mm ² /AWG)							[Nm][lb-in]
MC-18AF		1~6/18~10	1~6/18~10	1~6/18~10	1~6/18~10	1~6/18~10	1~10/18~8	up to 1.13/10	
MC-22AF		1~6/18~10	1~6/18~10	1~6/18~10	1~6/18~10	1~6/18~10	1~10/18~8	up to 2.25/20	
MC-40AF		1~6/18~10	2.5~10/14~8	2.5~10/14~8	2.5~10/14~8	2.5~10/14~8	1~10/18~8	up to 4/35	
MC-65AF		-	-	-	-	-	1~25/12~4	up to 4/35	
MC-100AF		-	-	-	-	-	1~25/12~4	up to 4/35	
MC-150AF		-	-	-	-	-	1~25/12~4	up to 9.8/87	
Coil terminal		0.5~2.5/20~14	0.75~25/18~12			0.5~25/20~12		up to 2.25/20	
MC-225AF		-	-	-	-	-	2.5~150/8~300	up to 14.7/130	
MC-400AF		-	-	-	-	-	2.5~200/8~700	up to 22.6/200	
MC-800AF		-	-	-	-	-	80~325/ 2/0~Busbar	up to 26.5/500	
Coil terminal		1.25~5.5/16~10	1.25~5.5/16~10			1.25~5.5/16~10		up to 1.75/15	

Control coil characteristics



Frame size			18AF	22AF	40AF	65AF	100AF	150AF
Type			MC-6a	MC-9b	MC-32a	MC-50a	MC-75a	MC-130a
			MC-9a	MC-12b	MC-40a	MC-65a	MC-85a	MC-150a
			MC-12a	MC-18b			MC-100a	
			MC-18a	MC-22b				
AC coil								
Control voltage	[Uc]		24, 32, 36, 42, 48, 80, 100, 110, 220, 230, 240, 380, 400, 415, 440, 500, 550V					
	50Hz	[V]	24, 48, 100, 110, 120, 200, 208, 220, 230, 240, 277, 380, 440, 480, 600V					
	60Hz	[V]	24, 48, 100, 110, 120, 200, 220, 230, 240, 380, 415, 440, 500, 550V					
Voltage limit	[Uc]		85 ~ 110% (50Hz)					
	Pick-up		85 ~ 110% (60Hz)					
	Drop-out		30 ~ 60%					
Coil consumption at 20°C								
AC 220V	Inrush	[VA]	58/56	58/56	53/50	110/104	229/216	108/104
	50/60Hz	Holding	[VA]	9.0/6.0	9.0/6.0	12.0/9.0	13.0/10.0	17.0/13.0
Heat dissipation		[W]	2.1/1.5	2.1/1.5	2.7/2.2	2.8/2.4	5.4/4.7	2.7/3.6
Operating time								
Closing	[ms]		12 ... 22	12 ... 22	12 ... 22	12 ... 22	15 ... 30	20 ... 40
	Opening	[ms]	4 ... 19	4 ... 19	4 ... 19	4 ... 19	10 ... 30	60 ... 70
DC coil								
Control voltage		[Uc]	12, 20, 24, 48, 60, 80, 100, 110, 125, 200, 220, 250					
Voltage limit	[Uc]		70 ~ 110%					
	Pick-up		10 ~ 30%					
Coil consumption at 20°C								
DC 110V	Inrush	[W]	9	9	7	9	18	213
	Holding	[W]	9	9	7	9	18	7.5
Time constant (L/R)		[ms]	28	28	28	65	75	
Operating time								
Closing	[ms]		35 ... 50	35 ... 50	50 ... 65	50 ... 65	100 ... 120	70 ... 80
	Opening	[ms]	4 ... 19	4 ... 19	4 ... 19	4 ... 19	10 ... 25	60 ... 70

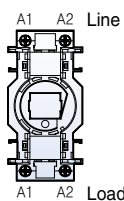

Note) A1(A2) in line side is internally connected to A1(A2) in load side.



Frame size		225AF	400AF	800AF
Type		MC-185a	MC-265a	MC-500a
		MC-225a	MC-330a MC-400a	MC-630a MC-800a
AC/DC common coil				
Control voltage [Uc]				
	AC/DC	24/24	-	-
	AC/DC	48/48	-	100/100
	AC/DC	100~240/100~220	100~240/100~220	200/200
	AC	300	300	300
	AC	400	400	400
	AC	500	500	500
Voltage limit [Uc]				
	Pick-up		86~110%	
	Drop-out		30~60%	
Coil consumption at 20°C				
AC 220V	Inrush [VA]	380	571	1000
50/60Hz	Holding [VA]	11.6	14	29
Heat dissipation [W]		4.7	5	7.8
Operating time				
	Closing [ms]	70	55	75
	Opening [ms]	70	55	75

Marking

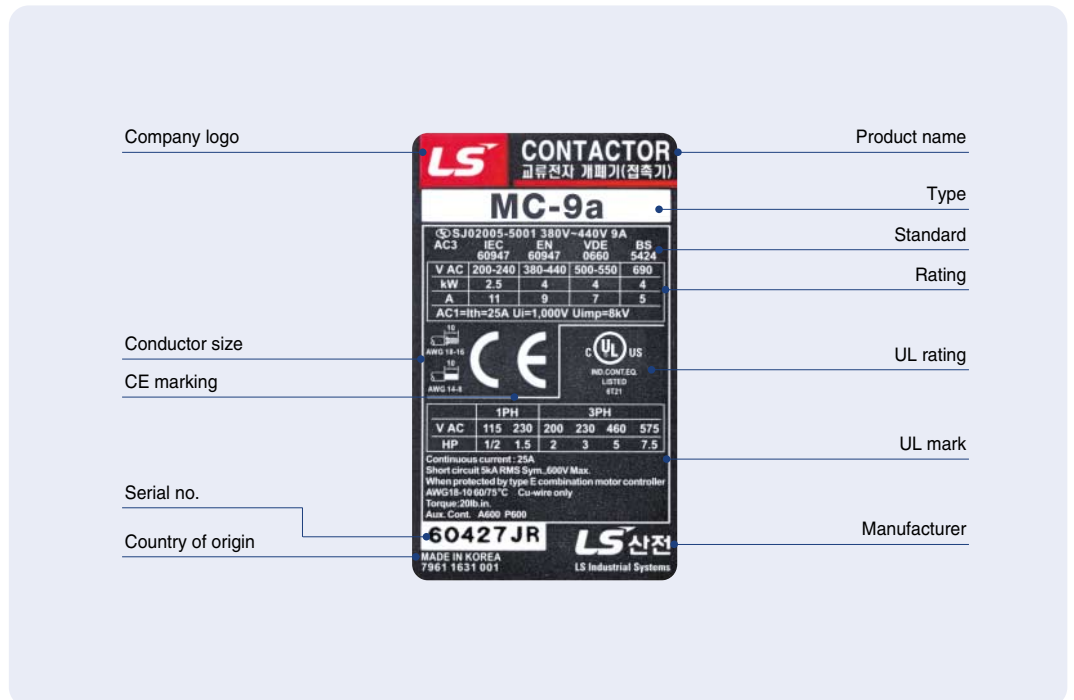
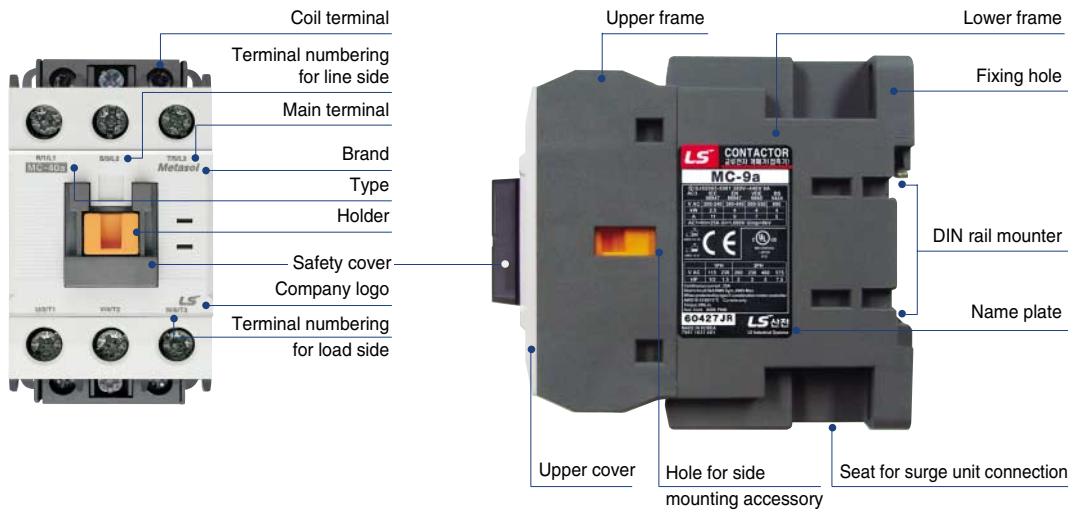

Internal structure

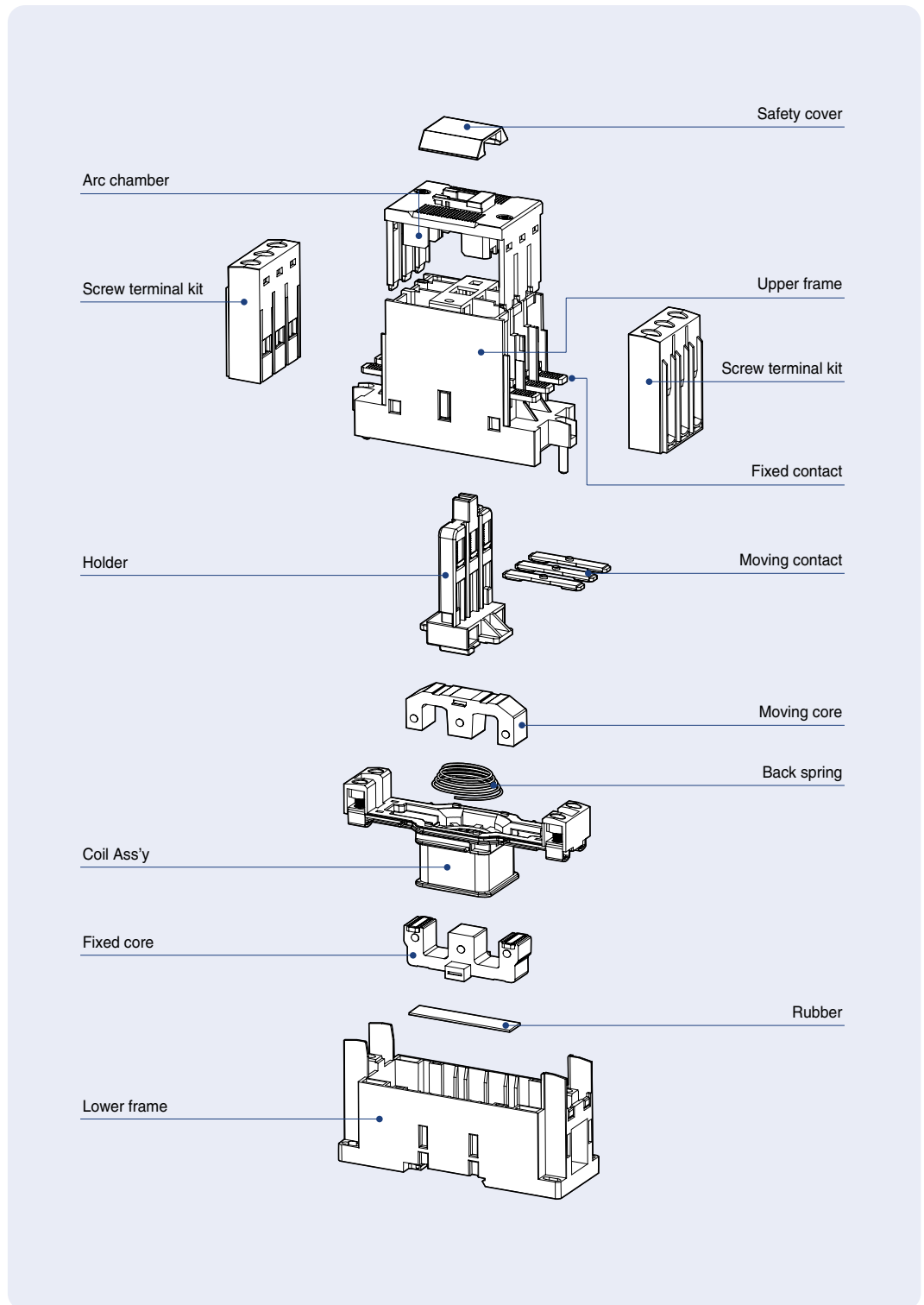

Contactors (18AF)

Description

- 3-pole(NO) main contact
- Finger proof design
- DIN rail or screw mountable
- AC or DC control in different physical size
- Front/side mountable accessories available
- Direct mountable overload relay available Rating
- 1NO or 1NC Auxiliary contact built-in as standard.

Rating



MC-18a

Contactor type			MC-6a		MC-9a		MC-12a		MC-18a		
			kW	A	kW	A	kW	A	kW	A	
AC duty	AC3	200/240V	2.2	9	2.5	11	3.5	13	4.5	18	
		380/440V	3	7	4	9	5.5	12	7.5	18	
		500/550V	3	6	4	7	7.5	12	7.5	13	
		690V	3	4	4	5	7.5	9	7.5	9	
	AC4	200/240V	1.5	7	1.5	8	2.2	11	3.7	16	
		380/440V	2.2	5	2.2	6	4	9	4	11	
AC1		-	25	-	25	-	25	-	32		
DC1 duty (L/R=1ms)	2-pole	24V	-	18	-	18	-	18	-	18	
		in series	48V	-	17	-	17	-	17	-	17
		110V	-	12	-	12	-	12	-	12	
	3-pole	24V	-	20	-	20	-	20	-	20	
		in series	48V	-	20	-	20	-	20	-	20
		110V	-	15	-	15	-	15	-	15	
DC2, 4 duty (L/R=15ms)	2-pole	24V	-	15	-	15	-	15	-	15	
		in series	48V	-	12	-	12	-	12	-	12
		110V	-	8	-	8	-	8	-	8	
	3-pole	24V	-	18	-	18	-	18	-	18	
		in series	48V	-	15	-	15	-	15	-	15
		110V	-	12	-	12	-	12	-	12	
Directly mountable Overload relay			MT-12								
Conductor size (solid, stranded) (the max. number of conducts: 2)	AWG		18~10		16~10		16~8		14~8		
	mm ²		1~4		1.5~4		1.5~10		2.5~10		
Conductor type			65/75°C Cu-wire only								



Coil voltage

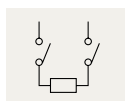

2-pole in series

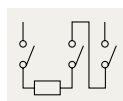

3-pole in series

AC	50Hz	24, 32, 42, 48, 80, 100, 110, 220, 230, 240, 380, 400, 500, 550V
	60Hz	24, 48, 110, 110, 12, 200, 208, 220, 230, 240, 277, 380, 480, 600V
	50/60Hz	24, 48, 100, 110, 120, 200, 220, 230, 240, 380, 415, 440, 500, 550V
DC	DC	12, 20, 24, 48, 60, 80, 100, 110, 125, 200, 220, 250V

Certification

- CE(IEC)
- UL508

Accessories



Surge unit, US
connecting to coil terminals
▶ 54 page

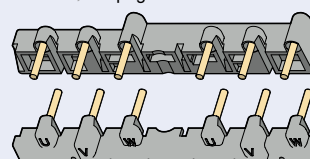

Wire kit, UW
for use with Interlock unit
▶ 50 page

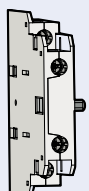

Auxiliary contact unit, UA1
side mount, 1NO+1NC
▶ 48 page

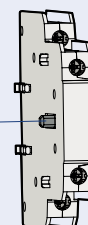
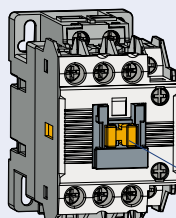

Interlock unit, UR
side mount
▶ 52 page

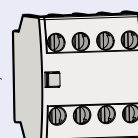

Auxiliary contact unit, AU-4
front mount, 4P
▶ 46 page



Auxiliary contact unit, AU-2
front mount, 2P
▶ 46 page

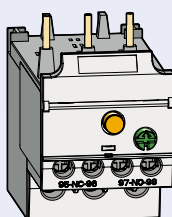

Overload relay, MT
directly mountable to MC type
contactor
▶ 60 page



Safety cover, A7
▶ 56 page

Contactors (22AF)

Description

- 3-pole(NO) main contact
- Finger proof design
- DIN rail or screw mountable
- AC or DC control in different physical size
- Front/side mountable accessories available
- Direct mountable overload relay available Rating
- 1NO or 1NC Auxiliary contact built-in as standard.



MC-22b

Rating

Contactor type			MC-9b		MC-12b		MC-18b		MC-22b		
			kW	A	kW	A	kW	A	kW	A	
AC duty	AC3	200/240V	2.5	11	3.5	13	4.5	18	5.5	22	
		380/440V	4	9	5.5	12	7.5	18	11	22	
		500/550V	4	7	7.5	12	7.5	13	15	20	
		690V	4	5	7.5	9	7.5	9	15	18	
	AC4	200/240V	1.5	8	2.2	11	3.7	16	3.7	18	
		380/440V	2.2	6	4	9	4	11	5.5	13	
AC1		-	25	-	25	-	32	-	40		
DC1 duty (L/R=1ms)	2-pole	24V	-	18	-	18	-	18	-	32	
		in series	48V	-	17	-	17	-	17	-	30
		110V	-	12	-	12	-	12	-	23	
	3-pole	24V	-	20	-	20	-	20	-	32	
		in series	48V	-	20	-	20	-	20	-	32
		110V	-	15	-	15	-	15	-	27	
DC 2,4 duty (L/R=15ms)	2-pole	24V	-	15	-	15	-	15	-	25	
		in series	48V	-	12	-	12	-	12	-	20
		110V	-	8	-	8	-	8	-	15	
	3-pole	24V	-	18	-	18	-	18	-	30	
		in series	48V	-	15	-	15	-	15	-	30
		110V	-	12	-	12	-	12	-	20	
Directly mountable Overload relay			MT-32								
Conductor size (solid, stranded)	AWG		16~10		16~8		14~8		14~8		
	(the max. number of conducts: 2)	mm ²	1.5~4		1.5~10		2.5~10		2.5~10		
Conductor type			65/75°C Cu-wire only								



Coil voltage

AC	50Hz	24, 32, 42, 48, 80, 100, 110, 220, 230, 240, 380, 400, 500, 550V
	60Hz	24, 48, 110, 110, 12, 200, 208, 220, 230, 240, 277, 380, 480, 600V
	50/60Hz	24, 48, 100, 110, 120, 200, 220, 230, 240, 380, 415, 440, 500, 550V
DC	DC	12, 20, 24, 48, 60, 80, 100, 110, 125, 200, 220, 250V

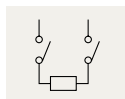

2-pole in series

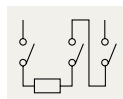

3-pole in series

Certification

- CE(IEC)
- UL508

Accessories

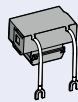

Surge unit, US
connecting to coil terminals
▶ 54 page

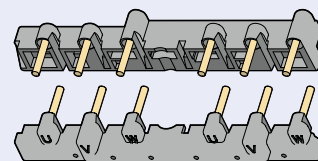

Wire kit, UW
for use with Interlock unit
▶ 52 page

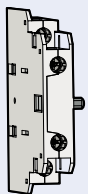

Auxiliary contact unit, UA1
side mount, 1NO+1NC
▶ 48 page

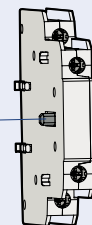
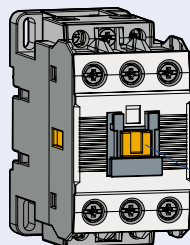

Interlock unit, UR
side mount
▶ 52 page

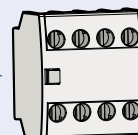

Auxiliary contact unit, AU-4
front mount, 4P
▶ 48 page



Auxiliary contact unit, AU-2
front mount, 2P
▶ 48 page

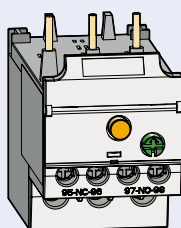

Overload relay, MT
directly mountable to MC type
contactor
▶ 61 page

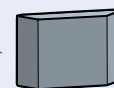

Safety cover, A7
▶ 57 page

Contactors (40AF)

Description

- 3-pole(NO) main contact
- Finger proof design
- DIN rail or screw mountable
- AC or DC control in different physical size
- Front/side mountable accessories available
- Direct mountable overload relay available Rating



MC-40a

Rating

Contactor type			MC-32a		MC-40a		
			kW	A	kW	A	
AC duty	AC3	200/240V	7.5	32	11	40	
		380/440V	15	32	18.5	40	
		500/550V	18.5	28	22	32	
		690V	18.5	20	22	23	
	AC4	200/240V	4.5	20	5.5	25	
		380/440V	7.5	17	11	24	
	AC1		-	50	-	60	
DC1 (L/R=1ms)	2-pole	24V	-	32	-	55	
		in series	48V	-	30	-	55
		110V	-	25	-	40	
	3-pole	24V	-	32	-	55	
		in series	48V	-	32	-	55
		110V	-	27	-	45	
DC2,4 (L/R=15ms)	2-pole	24V	-	25	-	30	
		in series	48V	-	20	-	25
		110V	-	15	-	20	
	3-pole	24V	-	30	-	45	
		in series	48V	-	30	-	40
		110V	-	20	-	30	
Directly mountable Overload relay			MT-32				
Conductor size (solid, stranded)		AWG	12~8		10~6		
(the max. number of conducts: 2)		mm ²	2.5~10		4~16		
Conductor type			65/75°C Cu-wire only				



Coil voltage

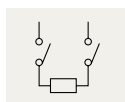

2-pole in series

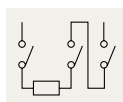

3-pole in series

AC	50Hz	24, 32, 42, 48, 80, 100, 110, 220, 230, 240, 380, 400, 500, 550V
	60Hz	24, 48, 110, 110, 12, 200, 208, 220, 230, 240, 277, 380, 480, 600V
	50/60Hz	24, 48, 100, 110, 120, 200, 220, 230, 240, 380, 415, 440, 500, 550V
DC	DC	12, 20, 24, 48, 60, 80, 100, 110, 125, 200, 220, 250V

Certification

- CE(IEC)
- UL508

Accessories

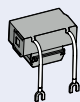

Surge unit, US
connecting to coil terminals
▶ 54 page

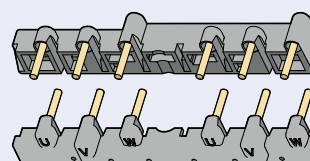

Wire kit, UW
for use with Interlock unit
▶ 52 page

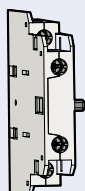

Auxiliary contact unit, UA1
side mount, 1NO+1NC
▶ 48 page

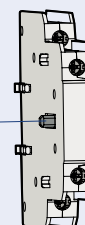
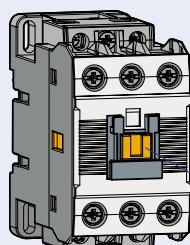

Interlock unit, UR
side mount
▶ 52 page

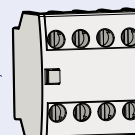

Auxiliary contact unit, AU-4
front mount, 4P
▶ 48 page



Auxiliary contact unit, AU-2
front mount, 2P
▶ 48 page

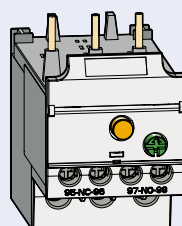

Overload relay, MT
directly mountable to MC type
contactor
▶ 61 page



Safety cover, A7
▶ 57 page

Contactors (65AF)

Description

- 3-pole(NO) main contact
- Finger proof design
- DIN rail or screw mountable
- AC or DC control in different physical size
- Front/side mountable accessories available
- Direct mountable overload relay available Rating



MC-65a

Rating

Contactor type			MC-50a		MC-65a		
			kW	A	kW	A	
AC duty	AC3	200/240V	15	55	18.5	65	
		380/440V	22	50	30	65	
		500/550V	30	43	33	60	
		690V	30	28	33	35	
	AC4	200/240V	7.5	35	11	50	
		380/440V	15	32	22	47	
	AC1		-	70	-	100	
DC1 duty (L/R=1ms)	2-pole	24V	-	70	-	90	
		in series	48V	-	70	-	90
			110V	-	50	-	75
	3-pole	24V	-	70	-	90	
		in series	48V	-	70	-	90
			110V	-	60	-	80
DC2, 4 duty (L/R=15ms)	2-pole	24V	-	45	-	55	
		in series	48V	-	40	-	45
			110V	-	25	-	38
	3-pole	24V	-	55	-	75	
		in series	48V	-	50	-	65
			110V	-	35	-	55
Directly mountable Overload relay			MT-63				
Conductor size (solid, stranded) (the max. number of conducts: 2)	AWG		10~4		8~3		
	mm ²		6~25		10~35		
Conductor type			65/75°C Cu-wire only				



Coil voltage

AC	50Hz	24, 32, 42, 48, 80, 100, 110, 220, 230, 240, 380, 400, 500, 550V
	60Hz	24, 48, 110, 110, 12, 200, 208, 220, 230, 240, 277, 380, 480, 600V
	50/60Hz	24, 48, 100, 110, 120, 200, 220, 230, 240, 380, 415, 440, 500, 550V
DC		12, 20, 24, 48, 60, 80, 100, 110, 125, 200, 220, 250V

Certification

- CE(IEC)
- UL508

Accessories



Surge unit, US
connecting to coil terminals
▶ 54 page

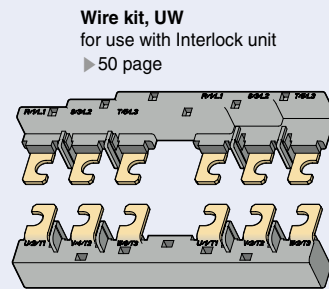

Wire kit, UW
for use with Interlock unit
▶ 50 page

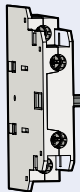

Auxiliary contact unit, UA1
side mount, 1NO+1NC
▶ 48 page

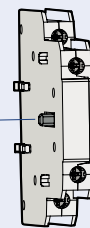
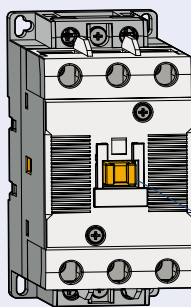

Interlock unit, UR
side mount
▶ 52 page

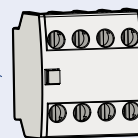

Auxiliary contact unit, AU-4
front mount, 4P
▶ 48 page

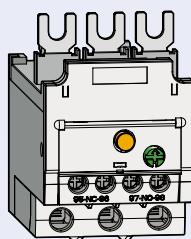

Overload relay, MT
directly mountable to MC type
contactor
▶ 61 page



Auxiliary contact unit, AU-2
front mount, 2P
▶ 48 page



Safety cover, A7
▶ 57 page

Contactors (100AF)

Description

- 3-pole(NO) main contact
- Finger proof design
- DIN rail or screw mountable
- AC or DC control in different physical size
- Front/side mountable accessories available
- Direct mountable overload relay available Rating



MC-100a

Rating

Contactor type			MC-75a		MC-85a		MC-100a		
			kW	A	kW	A	kW	A	
AC duty	AC3	200/240V	22	75	25	85	30	105	
		380/440V	37	75	45	85	55	105	
		500/550 V	37	64	45	75	55	85	
		690V	37	42	45	45	45	65	
	AC4	200/240V	13	55	15	65	19	80	
		380/440V	25	52	30	62	37	75	
	AC1		-	110	-	135	-	160	
DC1 duty (L/R=1ms)	2-pole	24V	-	90	-	100	-	100	
		in series	48V	-	90	-	100	-	100
		110V	-	75	-	80	-	80	
	3-pole	24V	-	90	-	100	-	100	
		in series	48V	-	90	-	100	-	100
		110V	-	80	-	85	-	85	
DC2, 4 duty (L/R=15ms)	2-pole	24V	-	55	-	60	-	60	
		in series	48V	-	45	-	50	-	50
		110V	-	38	-	40	-	40	
	3-pole	24V	-	75	-	80	-	80	
		in series	48V	-	65	-	70	-	70
		110V	-	55	-	60	-	60	
Directly mountable Overload relay			MT-95						
Conductor size (solid, stranded)	AWG		8~2		8~00		8~0		
	(the max. number of conducts: 2)	mm ²	10~35		10~50		10~70		
Conductor type			65/75°C Cu-wire only						



Coil voltage

AC	50Hz	24, 32, 42, 48, 80, 100, 110, 220, 230, 240, 380, 400, 500, 550V
	60Hz	24, 48, 110, 110, 12, 200, 208, 220, 230, 240, 277, 380, 480, 600V
	50/60Hz	24, 48, 100, 110, 120, 200, 220, 230, 240, 380, 415, 440, 500, 550V
DC	DC	12, 20, 24, 48, 60, 80, 100, 110, 125, 200, 220, 250V

Certification

- CE(IEC)
- UL508

Accessories

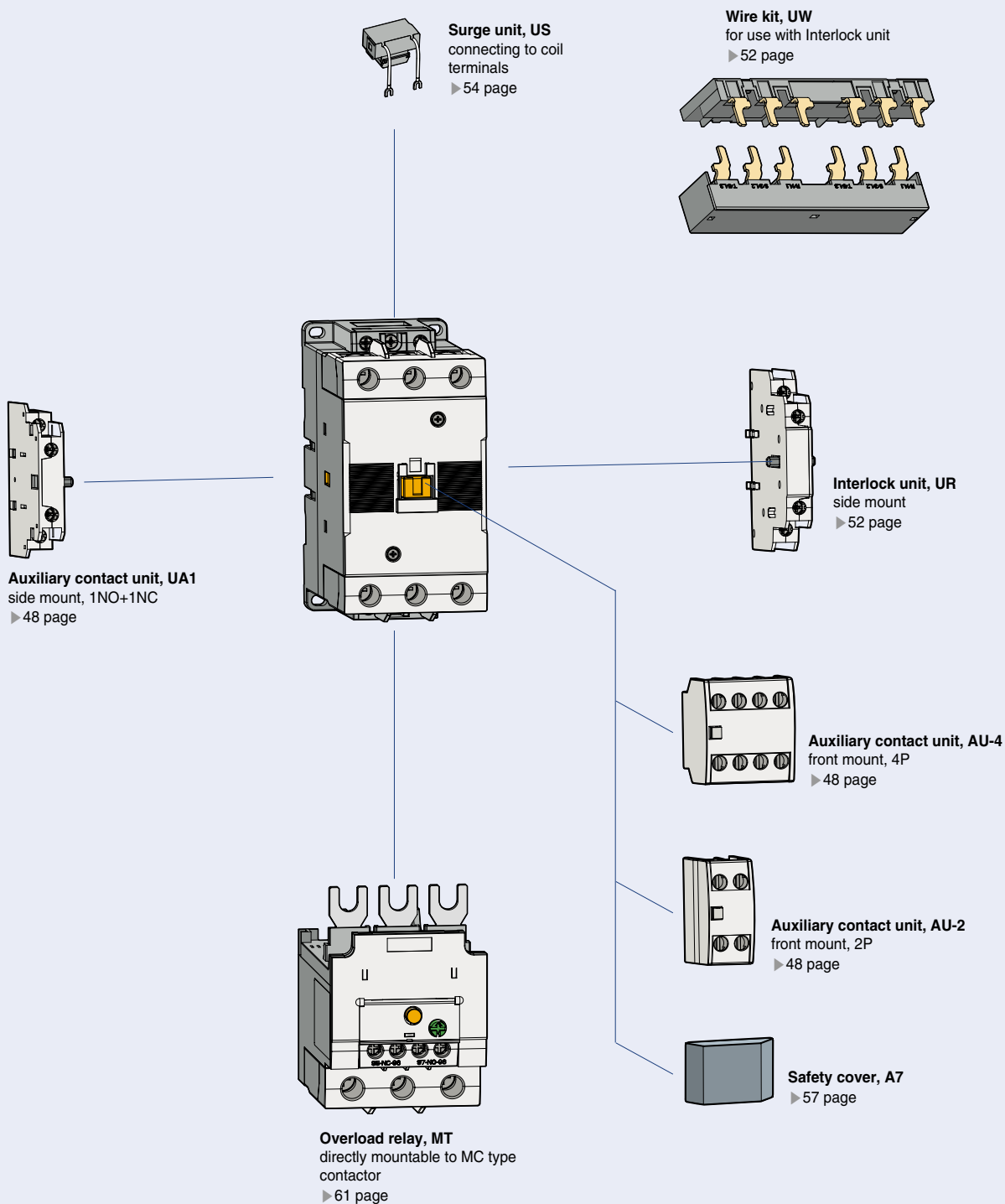

Contactors (150AF)

Description

- 3-pole(NO) main contact
- Finger proof design
- DIN rail or screw mountable
- AC or DC control in the same physical size
- Front/side mountable accessories available
- Direct mountable overload relay available

Rating



MC-150a

Contactor type			MC-130a		MC-150a		
			kW	A	kW	A	
AC duty	AC3	200/240V	37	130	45	150	
		380/440V	60	130	75	150	
		500/550V	60	90	70	100	
		690V	55	60	55	60	
	AC4	200/240V	22	93	30	120	
		380/440V	45	90	55	110	
	AC1		-	160	-	210	
DC1 duty (L/R=1ms)	2-pole	24V	-	120	-	150	
		in series	48V	-	100	-	120
		110V	-	80	-	100	
	3-pole	24V	-	120	-	150	
		in series	48V	-	120	-	150
		110V	-	100	-	150	
DC2, 4 duty (L/R=15ms)	2-pole	24V	-	120	-	150	
		in series	48V	-	60	-	100
		110V	-	40	-	80	
	3-pole	24V	-	120	-	150	
		in series	48V	-	90	-	130
		110V	-	80	-	120	
Directly mountable Overload relay			MT-150				
Conductor size (solid, stranded) (the max. number of conducts: 2)	AWG		3-00		3-00		
	mm ²		35-70		35-95		
Conductor type			65/75°C Cu-wire only				



Coil voltage

Control	Frequency	Voltages
AC	50/60Hz	24, 48, 110, 220, 300, 400, 500V
DC	DC	24, 48, 110, 220V

Certification

- CE(IEC)
- UL508

Accessories

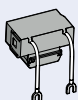

Surge unit, US
connecting to coil terminals
▶ 54 page

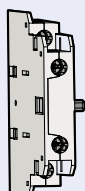

Auxiliary contact unit, UA1
side mount, 1NO+1NC
▶ 48 page

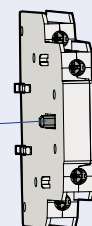
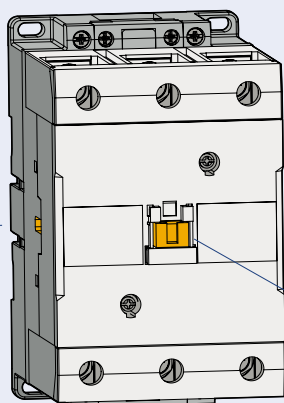

Interlock unit, UR
side mount
▶ 52 page

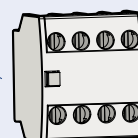

Auxiliary contact unit, AU-4
front mount, 4P
▶ 48 page



Auxiliary contact unit, AU-2
front mount, 2P
▶ 48 page

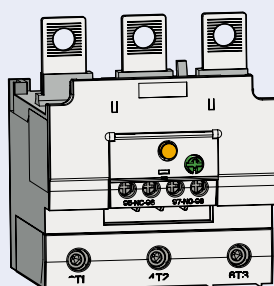

Overload relay, MT
directly mountable to MC type
contactor
▶ 62 page

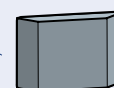

Safety cover, A7
▶ 57 page

Contactors (225AF)

Description

- 3-pole main contact
- AC/DC common use coil built
- Wide coil operation voltage
- Screw mountable
- 2NO+2NC Auxiliary contacts built-in as standard
- Top/side mountable accessories available
- Direct mountable overload relays available



MC-225a

Rating

Contactor type			MC-185a		MC-225a		
			kW	A	kW	A	
AC duty	AC3	200/240V	55	185	75	225	
		380/440V	90	185	132	225	
		500/550V	110	180	132	200	
		690V	110	120	140	150	
	AC4	200/240V	37	150	45	180	
		380/440V	75	150	90	180	
	AC1		-	230	-	275	
DC1 duty (L/R=1ms)	2-pole	24V	-	180	-	220	
		in series	48V	-	180	-	180
		110V	-	150	-	150	
	3-pole	24V	-	180	-	220	
		in series	48V	-	180	-	220
		110V	-	180	-	220	
DC2, 4 duty (L/R=15ms)	2-pole	24V	-	180	-	220	
		in series	48V	-	150	-	150
		110V	-	120	-	120	
	3-pole	24V	-	180	-	220	
		in series	48V	-	180	-	220
		110V	-	150	-	150	
Directly mountable Overload relay			MT-225				
Conductor size (solid, stranded) (the max. number of conducts: 2)	AWG		1~410		110~300		
	mm ²		50~95		50~150		
Conductor type			75°C Cu stranded wire				



Coil voltage, AC/DC common

Nominal(ordering) voltage	AC 50/60Hz	DC
24V	24 - 25V	24V
48V	48 - 50V	48V
100/200V	100 - 240V	100 - 220V
300V	265 - 347V	-
400V	380 - 450V	-
500V	440 - 575V	-

Certification

- CE(IEC)
- UL508

Accessories



AD-100
Delayed opening device
▶ 51 page



Safety cover, A7
▶ 57 page



AP-220
Terminal cover
▶ 51 page



AI-225
Insulation barrier
▶ 51 page



AU-100, 100E
Auxiliary contact unit
side mount, 1NO+1NC
▶ 49 page



AR-180
Interlock unit
side mount
▶ 53 page



MT-225
Overload relay
directly mountable to the contactor
Current range 65-240A
▶ 63 page

Contactors (400AF)

Description

- 3-pole main contact
- AC/DC common use coil built
- Wide coil operation voltage
- Screw mountable
- 2NO+2NC Auxiliary contacts built-in as standard
- Top/side mountable accessories available
- Direct mountable overload relays available



MC-400a

Rating

Contactor type			MC-265a		MC-330a		MC-400a		
			kW	A	kW	A	kW	A	
AC duty	AC3	200/240V	80	265	90	330	125	400	
		380/440V	147	265	160	330	200	400	
		500/550V	147	225	160	280	225	350	
		690V	160	185	200	225	250	300	
	AC4	200/240V	50	200	55	220	75	300	
		380/440V	102	200	110	220	150	300	
AC1		-	300	-	350	-	450		
DC1 duty (L/R=1ms)	2-pole	24V	-	220	-	300	-	400	
		in series	48V	-	180	-	240	-	240
		110V	-	150	-	200	-	200	
	3-pole	24V	-	220	-	300	-	400	
		in series	48V	-	220	-	300	-	400
		110V	-	220	-	300	-	400	
DC2, 4 duty (L/R=15ms)	2-pole	24V	-	220	-	300	-	400	
		in series	48V	-	150	-	200	-	200
		110V	-	120	-	150	-	150	
	3-pole	24V	-	220	-	300	-	400	
		in series	48V	-	220	-	280	-	280
		110V	-	150	-	200	-	200	
Directly mountable Overload relay			MT-400						
Conductor size (solid, stranded)	AWG		310~500		410~500		350~700		
	(the max. number of conducts: 2)	mm ²	95~240		95~240		185~370		
Conductor type			75°C Cu stranded wire						



Coil voltage, AC/DC common

Nominal(ordering) voltage	AC 50/60Hz	DC
100/200V	100 - 240V	100 - 220V
300V	265 - 347V	-
400V	380 - 450V	-
500V	440 - 575V	-

Certification

- CE(IEC)
- UL508

Accessories



AD-300
Delayed opening device
► 51 page

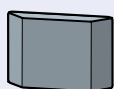

Safety cover, A7
► 57 page



AP-400
Terminal cover
► 51 page



AI-400
Insulation barrier
► 51 page



AU-100, 100E
Auxiliary contact unit
side mount, 1NO+1NC
► 49 page



AR-180
Interlock unit
side mount
► 53 page

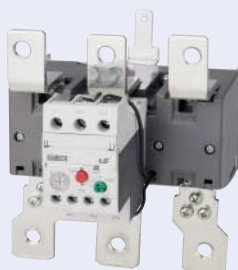

MT-400
Overload relay
directly mountable to the contactor
Current range 85–400A
► 63 page

Contactors (800AF)

Description

- 3-pole main contact
- AC/DC common use coil built
- Wide coil operation voltage
- Screw mountable
- 2NO+2NC Auxiliary contacts built-in as standard
- Top/side mountable accessories available
- Overload relays available



Rating

Contactor type			MC-500a		MC-630a		MC-800a		
			kW	A	kW	A	kW	A	
AC duty	AC3	200/240V	147	500	190	630	220	800	
		380/440V	265	500	330	630	440	800	
		500/550V	265	400	330	500	500	720	
		690V	300	380	400	420	500	630	
	AC4	200/240V	90	350	110	400	160	630	
		380/440V	176	350	200	400	300	630	
AC1		-	580	-	660	-	900		
DC1 duty (L/R=1ms)	2-pole	24V	-	400	-	630	-	800	
		in series	48V	-	240	-	630	-	800
		110V	-	200	-	630	-	630	
	3-pole	24V	-	400	-	630	-	800	
		in series	48V	-	400	-	630	-	800
		110V	-	400	-	630	-	800	
DC2, 4 duty (L/R=15ms)	2-pole	24V	-	400	-	630	-	800	
		in series	48V	-	200	-	630	-	630
		110V	-	150	-	630	-	630	
	3-pole	24V	-	400	-	630	-	800	
		in series	48V	-	280	-	630	-	630
		110V	-	200	-	630	-	630	
Directly mountable Overload relay			MT-800						
Conductor size (solid, stranded)	AWG		350~800		600~2000		1700~Busbar		
	(the max. number of conducts: 2)	mm ²	185~480		-		-		
Conductor type			75°C Cu stranded wire						



Coil voltage, AC/DC common

Nominal(ordering) voltage	AC 50/60Hz	DC
100V	100 - 127V	100 - 110V
200V	200 - 240V	200 - 220V
300V	265 - 347V	-
400V	380 - 450V	-
500V	440 - 575V	-

Certification

- CE(IEC)
- UL508

Accessories

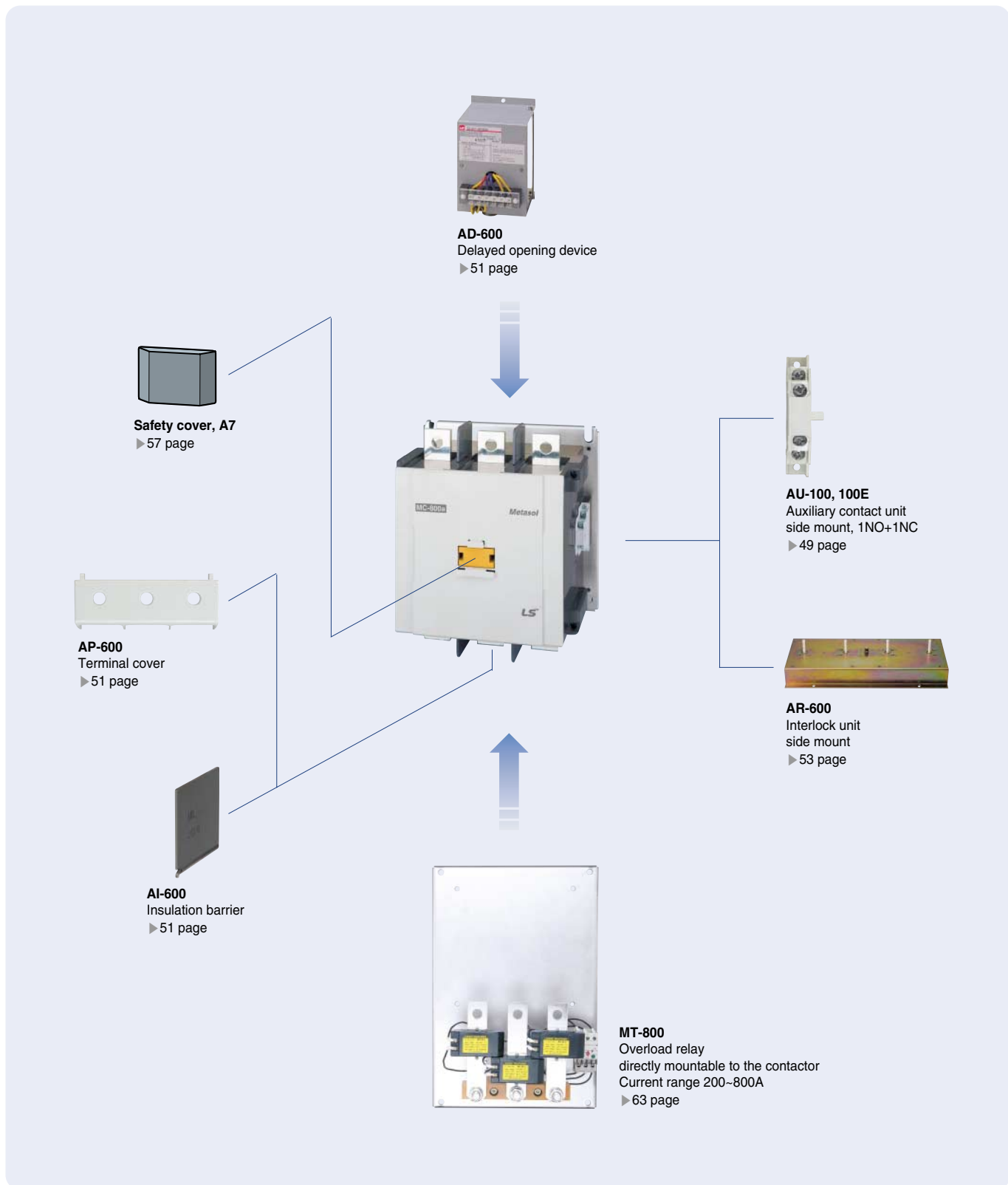

Motor starters

Description

- Opened direct motor starter
- 3-pole(NO) main contact
- Finger proof design
- DIN rail or screw mountable
- AC or DC control contactor selectable
- Front/side mountable accessories available
- Overload relay is directly mounted to the contactor



Rating

Starter type	18AF				22AF			
	MS-6a	MS-9a	MS-12a	MS-18a	MS-9b	MS-12b	MS-18b	MS-22b
Number of poles	3				3			
Rated operational voltage (Ue)	Up to 690V				Up to 690V			
Degree of pollution (IEC60529)	IP20				IP20			
Rated operational current Ie ($\theta \leq 40^\circ\text{C}$)								
AC-1 Ue max 690V A	25	25	25	32	25	25	32	40
AC-3 200/240V A	9	11	13	18	11	13	18	22
380/400V A	7	9	12	18	9	12	18	22
415V A	7	9	12	18	9	12	18	22
440V A	7	9	12	18	9	12	18	22
500V A	6	7	12	13	7	12	13	20
690V A	4	5	9	9	6	9	9	18
Rated operational power ($\theta \leq 40^\circ\text{C}$)								
AC-3 200/240V kW	2.2	2.5	3.5	4.5	2.5	3.5	4.5	5.5
380/400V kW	3	4	5.5	7.5	4	5.5	7.5	11
415V kW	3	4	5.5	7.5	4	5.5	7.5	11
440V kW	3	4	5.5	7.5	4	5.5	7.5	11
500V kW	3	4	7.5	7.5	4	7.5	7.5	15
690V kW	3	4	7.5	7.5	4	7.5	7.5	15
According to IEC60947-4-1								
Rated making capacity AC-3	70	90	120	180	90	120	180	220
Rated breaking capacity AC-3	56	72	96	144	72	96	144	176
Electrical life for Ie/AC-3 Max in millions of operating cycles	2.5	2.5	2.5	2.5	2.5	2.5	2.5	2.5
Maximum operating rate in operating cycles per hour	1800	1800	1800	1800	1800	1800	1800	1800

Devices usable in the starter combination

Contactors		18AF				22AF			
		MC-6a	MC-9a	MC-12a	MC-18a	MC-9b	MC-12b	MC-18b	MC-22b
with AC or DC control coil									
with coil in common use for AC and DC		-	-	-	-	-	-	-	-
Thermal Overload Relays									
Class 10A Differential type		MT-12/3K				MT-32/3K			
Non-differential type		MT-12/3H				MT-32/3H			
Non-differential type(2-heater)		MT-12/2H				MT-32/2H			
Class 20 Differential type		MT-12/3D				MT-32/3D			
Setting range	A	0.1~18A				0.1~40A			



40AF	
MS-32a	MS-40a
3	
Up to 690V	
IP20	
50	60
32	40
32	40
32	40
32	40
28	32
20	23
7.5	11
15	18.5
15	18.5
15	18.5
18.5	22
18.5	22
320	400
256	320
2	2
1800	1800

65AF	
MS-50a	MS-65a
3	
Up to 690V	
IP20	
70	100
55	65
50	65
50	65
50	65
43	60
28	35
15	18.5
22	30
22	30
22	30
30	33
30	33
500	650
400	520
2	2
1800	1800

100AF		
MS-75a	MS-85a	MS-100a
3		
Up to 690V		
IP20		
110	135	160
75	85	105
75	85	105
75	85	105
75	85	105
64	75	85
42	45	65
22	25	30
37	45	55
37	45	55
37	45	55
37	45	55
37	45	45
750	850	1050
600	650	840
2	2	2
1800	1800	1800

MC-32a	MC-40a
-	-
MT-32/3K	
MT-32/3H	
MT-32/2H	
MT-32/3D	
0.1~40A	

MC-50a	MC-65a
-	-
MT-63/3K	
MT-63/3H	
MT-63/2H	
MT-63/3D	
4~65A	

MC-75a	MC-85a	MC-100a
-	-	-
MT-95/3K		
MT-95/3H		
MT-95/2H		
MT-95/3D		
7~100A		

Motor starters

Description

- Opened direct motor starter
- 3-pole(NO) main contacts
- Screw mountable
- AC/DC common use control contactor used (from 225AF)
- Additional accessories available
- Overload relay is directly mounted to the contactor



Rating

Starter type	150AF		225AF	
	MS-130a	MS-150a	MS-185a	MS-225a
Number of poles	3		3	
Rated operational voltage (Ue)	Up to 690V		Up to 690V	
Degree of pollution (IEC60529)	IP20		IP20	
Rated operational current Ie ($\theta \leq 40^\circ\text{C}$)				
AC-1 Ue max 690V A	160	210	230	275
AC-3 200/240V A	130	150	185	225
380/400V A	130	150	185	225
415V A	130	150	185	225
440V A	130	150	185	225
500V A	90	100	180	200
690V A	60	60	120	150
Rated operational power ($\theta \leq 40^\circ\text{C}$)				
AC-3 200/240V kW	37	45	55	75
380/400V kW	60	75	90	132
415V kW	60	75	90	132
440V kW	60	75	90	132
500V kW	60	70	110	132
690V kW	55	55	110	140
According to IEC60947-4-1				
Rated making capacity AC-3	1200	1500	1850	2250
Rated breaking capacity AC-3	960	1200	1480	1800
Electrical life for Ie/AC-3 Max in millions of operating cycles	1	1	1	1
Maximum operating rate in operating cycles per hour	1200	1200	1200	1200

Devices usable in the starter combination

Contactors		150AF		225AF	
		MC-130a	MC-150a	-	-
with AC or DC control coil		MC-130a	MC-150a	-	-
with coil in common use for AC and DC		-	-	MC-185a	MC-225a
Thermal Overload Relays		150AF		225AF	
Class 10A Differential type	Non-differential type	MT-150/3K		MT-225/3K	
	Non-differential type	MT-150/3H		MT-225/3H	
	Non-differential type(2-heater)	MT-150/2H		MT-225/2H	
Class 20 Differential type	MT-150/3D		MT-225/3D		
Setting range	A	34-150A		65-240A	



400AF		
MS-265a	MS-330a	MS-400a
3		
Up to 690V		
IP20		
300	350	450
265	330	400
265	330	400
265	330	400
265	330	400
225	280	350
185	225	300
80	90	125
147	160	200
147	160	200
147	160	200
147	160	225
160	200	250
2650	3300	4000
2120	2640	3200
1	1	1
1200	1200	1200

800AF		
MS-500a	MS-630a	MS-800a
3		
Up to 690V		
IP20		
580	660	900
500	630	800
500	630	800
500	630	800
500	630	800
400	500	720
380	420	630
147	190	220
265	330	440
265	330	440
265	330	440
265	330	500
300	400	500
5000	6300	8000
4000	5040	6400
0.5	0.5	0.5
1200	1200	1200

-	-	-
MC-265a	MC-330a	MC-400a
MT-400/3K		
MT-400/3H		
MT-400/2H		
MT-400/3D		
85~400A		

-	-	-
MC-500a	MC-630a	MC-800a
MT-800/3K		
MT-800/3H		
MT-800/2H		
MT-800/3D		
200~800A		

Reversing contactors

Description

- Two AC or DC control contactors are interlocked mechanically and electrically
- 3-pole(NO) main contact in each contactor
- Finger proof design
- DIN rail or screw mountable
- Front/side mountable accessories available
- Overload relay can be directly mounted to the contactor if necessary

Circuit diagram

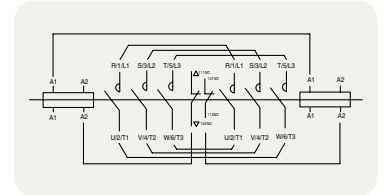

Rating

Type	AC-3 duty						Current (AC3)	Weight (AC control)
	200 ~ 240V	380 ~ 400V	415V	440V	500V	690V	440V	
	kW	kW	kW	kW	kW	kW	A	
MC-6a/R	2.2	3	3	3	3	3	7	0.63kg
MC-9a/R	2.5	4	4	4	4	4	9	0.63kg
MC-12a/R	3.5	5.5	5.5	5.5	7.5	7.5	12	0.63kg
MC-18a/R	4.5	7.5	7.5	7.5	7.5	7.5	18	0.63kg
MC-9b/R	2.5	4	4	4	4	4	9	0.75kg
MC-12b/R	3.5	5.5	5.5	5.5	7.5	7.5	12	0.75kg
MC-18b/R	4.5	7.5	7.5	7.5	7.5	7.5	18	0.75kg
MC-22b/R	5.5	11	11	11	15	15	25	0.75kg
MC-32a/R	11	18.5	18.5	18.5	22	22	32	0.95kg
MC-40a/R	11	18.5	18.5	18.5	22	22	40	0.95kg
MC-50a/R	15	22	22	22	30	30	50	1.7kg
MC-65a/R	18.5	30	30	30	33	33	65	1.7kg
MC-75a/R	22	37	37	37	37	37	75	3.3kg
MC-85a/R	25	45	45	45	45	45	85	3.3kg
MC-100a/R	30	55	55	55	55	45	100	3.3kg



MC-40a/R



MC-65a/R



MC-100a/R

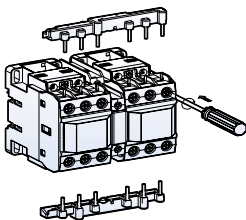

Coil voltage

AC	50Hz	24, 32, 42, 48, 80, 100, 110, 220, 230, 240, 380, 400, 500, 550V
	60Hz	24, 48, 110, 110, 12, 200, 208, 220, 230, 240, 277, 380, 480, 600V
	50/60Hz	24, 48, 100, 110, 120, 200, 220, 230, 240, 380, 415, 440, 500, 550V
DC	DC	12, 20, 24, 48, 60, 80, 100, 110, 125, 200, 220, 250V

Certification

- CE(IEC)
- UL508

Description

- 3-pole main contact
- Mechanically interlocked
- AC/DC common use coil built (from MC-185a/R)
- Wide coil operation voltage
- Screw mountable
- 2NO+2NC Auxiliary contacts built-in as standard
- Top/side mountable accessories available



Rating

Type	AC-3 duty						Current (AC3)	Weight (AC control)
	200 ~ 240V	380 ~ 400V	415V	440V	500 ~ 550V	690V	440V	
	kW	kW	kW	kW	kW	kW	A	
MC-130a/R	37	60	60	60	60	55	120	4.3kg
MC-150a/R	45	75	75	75	75	55	150	4.3kg
MC-185/R	55	90	90	90	110	110	185	13kg
MC-225a/R	75	132	132	132	132	140	225	13kg
MC-265a/R	80	147	147	147	147	160	265	21.4kg
MC-330a/R	90	160	160	160	160	200	330	21.4kg
MC-400a/R	125	200	200	200	225	250	400	21.4kg
MC-500a/R	147	265	265	265	265	300	500	60kg
MC-630a/R	190	330	330	330	330	400	630	60kg
MC-800a/R	220	440	440	440	440	500	800	60kg



Coil voltage

For MC130/R and MC-150a/R

AC	50/60Hz	24, 48, 110, 220, 300, 400, 500V
DC	DC	24, 48, 110, 220V

For MC-185a/R and up

- 24, 48, 100/200, 300, 400, 500V for types MC-185a/R, 225/R
- 100/200, 300, 400, 500V for types MC-265a/R, 330/R, 400/R
- 100, 200, 300, 400, 500V for types MC-500a/R, 600/R, 800/R

Nominal(ordering) voltage	AC 50/60Hz	DC
24V	24 - 25V	24V
48V	48 - 50V	48V
100V	100 - 127V	100 - 110V
200V	200 - 240V	200 - 220V
100/200V	100 - 240V	100 - 220V
300V	265 - 347V	-
400V	380 - 450V	-
500V	440 - 575V	-

Capacitive contactors

Description

Capacitor unit(Pre-loading resistor) is connected to the terminals of the contactor to reduce the high inrush current exceeding $20 \times I_n$.

- AC or DC control coil on selection
- 3-pole(NO) main contact
- Finger proof design
- DIN rail or screw mountable

Rating

Type	Maximum operating power (kvar)			Rated current (A)	Capacitor unit type
	220 ~ 240V	400 ~ 440V	500 ~ 550V		
MC-9a/9b(D)	5	9.7	14	14	AC-9
MC-12a/12b(D)	6.7	12.5	18	18	AC-9
MC-18a/18b(D)	8.5	16.7	24	24	AC-9
MC-22b(D)	10	18	26	26	AC-9
MC-32a(D)	15	25	36	36	AC-9
MC-40a(D)	20	33.3	48	48	AC-9
MC-50a(D)	20	40	58	58	AC-50
MC-65a(D)	25	45.7	66	66	AC-50
MC-75a(D)	29.7	54	78	78	AC-50
MC-85a(D)	35	60	92	92	AC-50
MC-100a(D)	37	62	94	94	AC-50

Note) - When the switch is closed condenser must be discharged before recharged. (Maximum residual voltage at terminals $\leq 50V$)
 - To prevent short current, gG type fuse must be 1.5-2 times than rated current.



Coil voltage

50Hz	24, 32, 42, 48, 80, 100, 110, 220, 230, 240, 380, 400, 500, 550V
AC	60Hz 24, 48, 110, 110, 12, 200, 208, 220, 230, 240, 277, 380, 480, 600V
	50/60Hz 24, 48, 100, 110, 120, 200, 220, 230, 240, 380, 415, 440, 500, 550V
DC	DC 12, 20, 24, 48, 60, 80, 100, 110, 125, 200, 220, 250V

These capacitive contactors are suitable for switching single-step or multiple-step condenser bank.

It is standardized by IEC-60947-4941, UL and CSA.

Features of capacitor unit(Pre-loading resistor)

- Damping resistor that can limit the inrush current upto $60 \times I_n$ is connected to the mechanism that closed earlier than the main contact of the contactor
- No heat loss by the serial resistor
- Eliminate the switching surge
- Improving the performance of the capacitor system

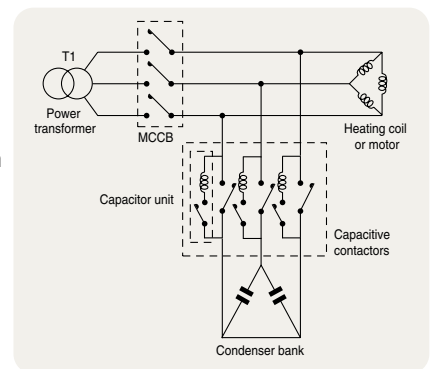

Example

Metasol Accessories

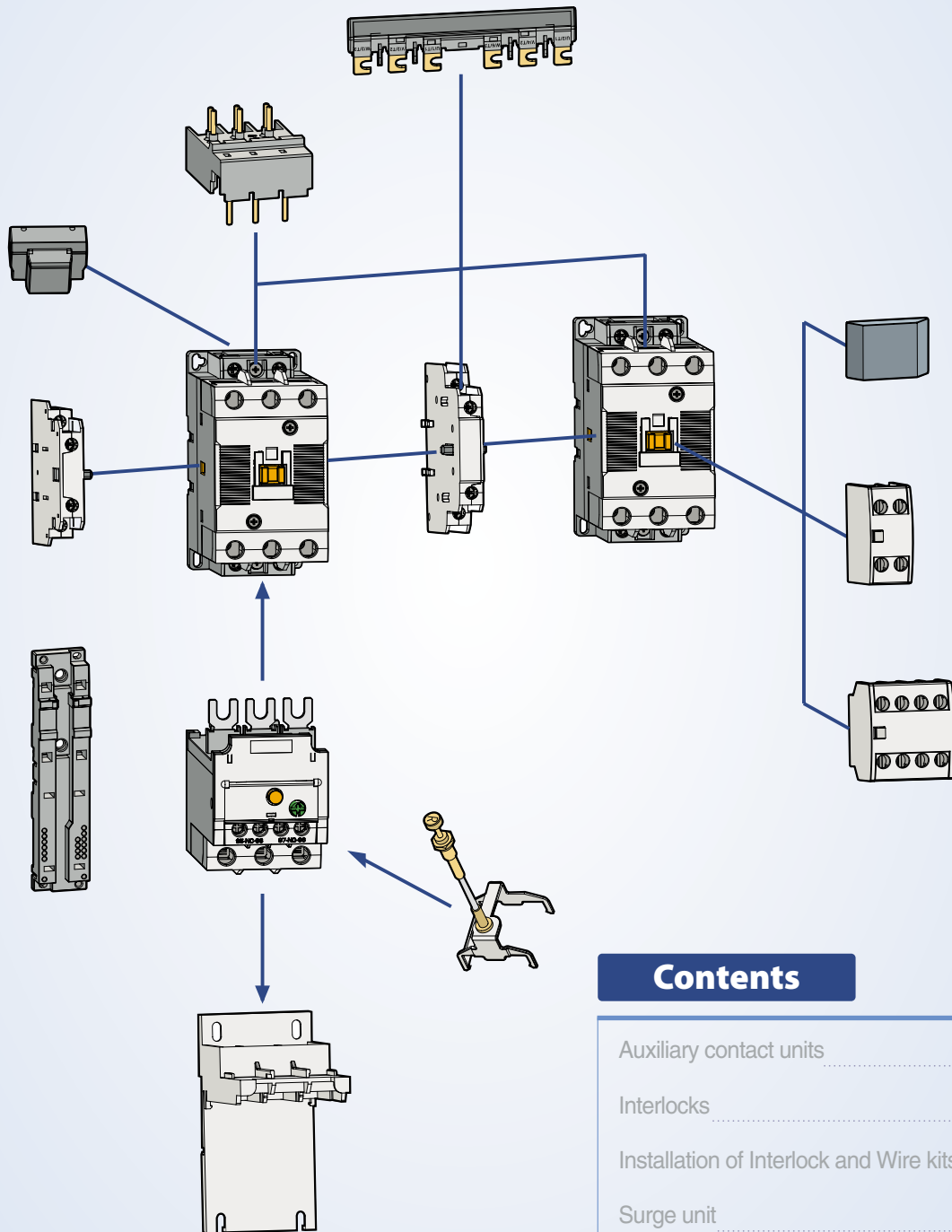

Contents

Auxiliary contact units	48
Interlocks	52
Installation of Interlock and Wire kits	53
Surge unit	54
Capacitor unit	55
Replacement coils	56
Safety cover (Option)	57

Auxiliary contact units

- 2 and 4 pole
- Side or front mountable
- Common use for Metasol contactors from MC-6 to MC-150a

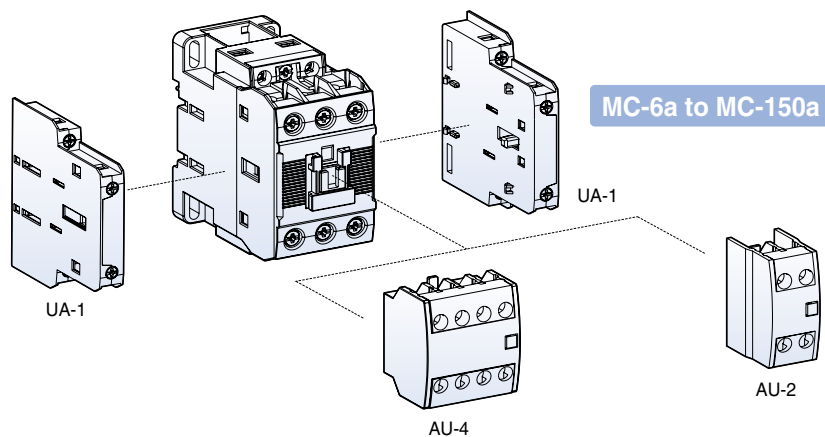

Selection

Type	Appearance	Pole	Composition		Contact arrangement	Mount	Weight
			NO	NC			
UA-1		2	1	1		Side	53g
AU-2		2	2 1 -	- 1 2		Front	28g
AU-4		4	4 3 2 1 -	- 1 2 3 4		Front	50g

Maximum combination of contact units

For contactors with AC coils	For contactors with DC coils
AU-4(on front)+UA-1 × 4EA (2EA on both sides)	AU-4(on front)+UA-1 × 2EA (1EA on both sides)
AU-2(on front)+UA-1 × 4EA (2EA on both sides)	AU-2(on front)+UA-1 × 2EA (1EA on both sides)

- 2 pole
- Side mountable
- MC MC Common use for Metasol contactors from MC-185a to MC-800a

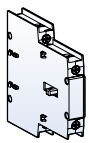
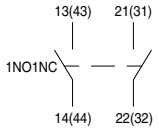
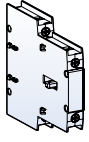
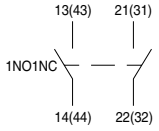

Selection

Type	Appearance	Pole	Composition		Contact arrangement	Mount	Weight
			NO	NC			
AU-100		2	1	1		Side	53g
AU-100E		2	1	1		Side	53g

Auxiliary contact units

Rating

Type		UA-1	AU-2, 4	AU-100	AU-100E
Rated operation voltage (Ue)		600V	600V	600V	60V
Rated insulation voltage (Ui)		600V	600V	600V	600V
Rated impulse withstand voltage (Uimp)		6kV	6kV	6kV	6kV
Rated frequency		50/60Hz	50/60Hz	50/60Hz	50/60Hz
Contact sensibility					
	Voltage	DC 17V	DC 24V	DC 24V	DC 7V
	Current	DC 5mA	DC 10mA	DC 10mA	DC 5mA
Rated thermal current (Ith, AC12 duty)		10A	16A	16A	1A
Rated operation current					
AC15 duty (A600)	120V	6A	6A	6A	AC/DC 24V 0.1A AC/DC 50V 0.01A
	240V	3A	3A	3A	
	380V	1.9A	1.9A	1.9A	
	480V	1.5A	1.5A	1.5A	
	500V	1.4A	1.4A	1.4A	
	600V	1.2A	1.2A	1.2A	
DC13 duty (P600)	125V	1.1A	1.1A	1.1A	
	250V	0.55A	0.55A	0.55A	
	400V	0.31A	0.31A	0.31A	
	500V	0.27A	0.27A	0.27A	
	600V	0.2A	0.2A	0.2A	
Electrical lifetime (mil. operations)					
AC15 duty	220V	0.5	0.5	0.5	AC/DC 24V 1A AC/DC 50V 1A
	440V	0.5	0.5	0.5	
DC13 duty	220V	0.5	0.5	0.5	
	440V	0.5	0.5	0.5	
Maximum operating cycles per hour		1800	1800	1800	1200
Conductor size (Solid, stranded)	AWG	18~10	18~10	18~10	18~10
	(the max. number of conducts: 2) mm ²	1~2.5	1~2.5	1~2.5	1~2.5

Installation

UA-1

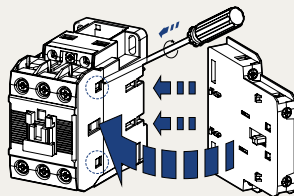

To install side mounting unit remove the indicated part in the circle in the fig. first. And then fit each part as shown. To separate push forward and pull.

AU-2, 4

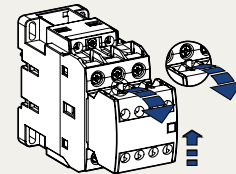

To install front mounting unit fit it on the upper part of the front of the contactor and push it down. To separate pull the lever of the unit and push the unit upward.

Delayed opening devices



Delayed opening device prevents the inadvertent opening of a contactor in the event of a wide voltage drop or brief supply voltage interruptions of control power for 1 to 4 seconds.

Applying contactors	Type	Control voltage	
		Delayed opening device coil	Contactor device coil
MC-185a, 225a (225AF)	AD-100	AC100~110V	DC100/110V
MC-265a, 330a, 400a (400AF)	AD-300	AC200~220V	DC200/220V
MC-500a, 630a, 800a (800AF)	AD-600		

Terminal cover units for contactors



Applying contactors	Type	Remarks
MC-185a, 225a (225AF)	AP-220	
MC-265a, 330a, 400a (400AF)	AP-400	2 pcs included
MC-500a, 630a, 800a (800AF)	AP-800	

Insulation barrier units



Applying contactors	Type	Remarks
MC-185a, 225a (225AF)	AI-180	
MC-265a, 330a, 400a (400AF)	AI-180	4 pcs required per contactor
MC-500a, 630a, 800a (800AF)	AI-600	

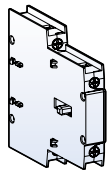

Interlock unit

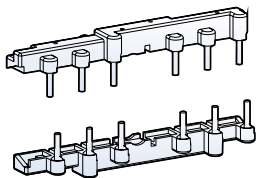

Wire kit

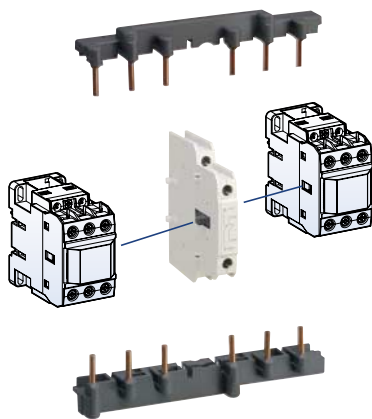

Interlocks

Component parts for assembling by customer

Interlock unit, UR-02

UR-02 is a mechanical interlock unit and provides 2NC contacts for use in electrical interlocking

Wire kit, UW

UW is used for making reversing circuit between two contactors.

Contactor	Wire kit		Interlock unit	
	Type	Weight	Type	Weight
MC-6a~18a	UW-18	0.05kg	UR-02	0.06kg
MC-9b~22b	UW-22	0.04kg		
MC-32a~40a	UW-32	0.05kg		
MC-50a, 65a	UW-63	0.12kg		
MC-75a~100a	UW-95	0.33kg		

Rating of the contacts in the interlocks

Rated operation voltage	600V	
Rated insulation voltage	600V	
Rated frequency	50/60Hz	
Rated thermal current	10A	
Rated operation current		
AC15 duty	120V	6A
(A600)	240V	3A
	380V	1.9A
	480V	1.5A
	500V	1.4A
	600V	1.2A
DC13 duty	125V	0.55A
(Q300)	250V	0.27A

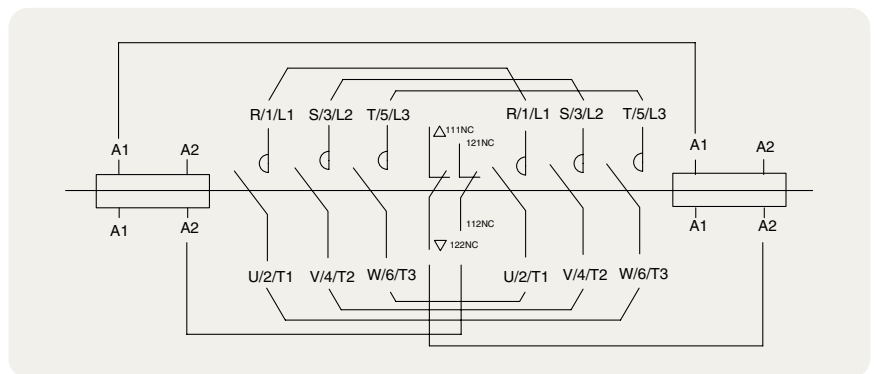

Typical circuit diagram for reversing contactor



AR-180

Interlock unit, AR-180 and AR-600

AR-180 and AR-600 are mechanical interlock units in which electrical contacts for use in electrical interlocking are not included. Please use the auxiliary contacts on the sides of the contactors for that purpose.



AR-600

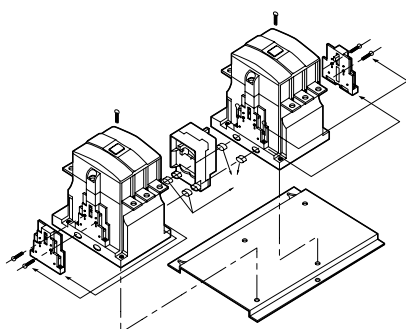

Contactor	Interlock unit	
	Type	Weight
MC-180a	AR-180	0.09kg
MC-225a		
MC-265a		
MC-330a		
MC-400a		
MC-500a	AR-600	15.2kg
MC-630a		
MC-800a		

Installation of Interlock and Wire kits

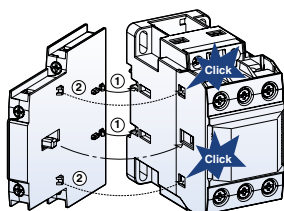

Install the interlock unit on the side of a contactor first. Fit each part as indicated in the fig.

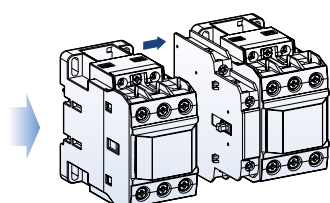

And then install the other contactor on the other side of the interlock unit as shown.

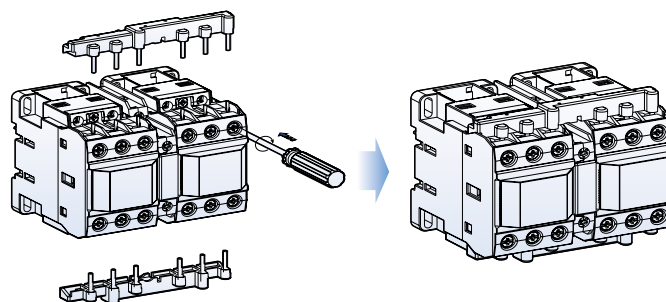

After installing interlock unit wiring kit can be assembled.

Wiring kit contains two molded wires - one for line side and the other for load side.

Surge unit

It absorbs the surge arisen out of the coil of the contactor.
It can be installed simply to the contactor.

- Rated operation voltage (Ue): AC 24 ~ 440V
DC 24 ~ 125V
- Rated insulation voltage (Ui): 1000V
- Rated impulse withstand voltage (Uimp): 8kV
- Degree of protection: IP20

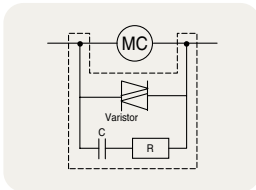

US-1-6

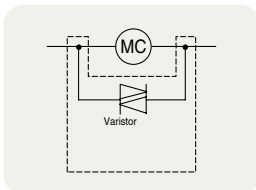

US-11-14

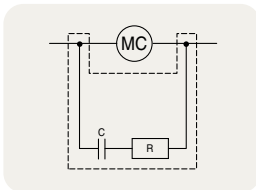

US-22

Surge unit		Rated voltage		Internal elements spec.			Weight
Type	Composition			V	R	C	
US-1	Varistor+RC	AC	24~48V	120V	100 Ω	0.1 μF	29g
US-2	Varistor+RC		100~125V	270V	100 Ω	0.1 μF	
US-3	Varistor+RC		200~240V	470V	100 Ω	0.1 μF	
US-4	Varistor+RC	DC	24~48V	120V	100 Ω	0.47 μF	
US-5	Varistor+RC		100~125V	270V	100 Ω	0.47 μF	
US-6	Varistor+RC		200~220V	470V	100 Ω	0.47 μF	
US-11	Varistor	AC/DC common	24~48V	120V	-	-	
US-12	Varistor		100~125V	270V	-	-	
US-13	Varistor		200~240V	470V	-	-	
US-14	Varistor		380~440V	1000V	-	-	
US-22	RC	AC	100~125V	-	56 Ω	1 μF	

Installation

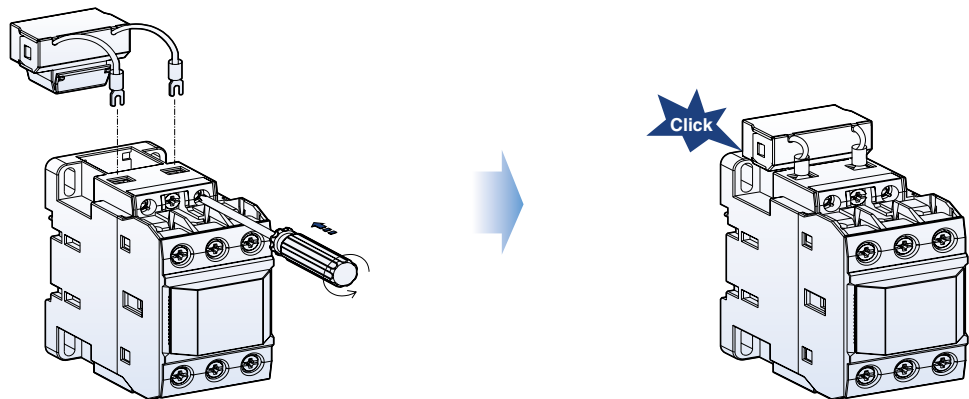

Connect the lead wires to the coil terminals of the contactor first.
And then insert the body into the space of the contactor as shown above.

Capacitor unit

Capacitor unit is connected to the terminals of the contactor to reduce the high inrush current.



Type	Contactor	Maximum operating power (kvar)			Rated current (A)
		220 ~ 240V	400 ~ 440V	500 ~ 550V	
AC-9	MC-9a/9b(D)	5	9.7	14	14
	MC-12a/12b(D)	6.7	12.5	18	18
	MC-18a/18b(D)	8.5	16.7	24	24
	MC-22b(D)	10	18	26	26
	MC-32a(D)	15	25	36	36
	MC-40a(D)	20	33.3	48	48
AC-50	MC-50a(D)	20	40	58	58
	MC-65a(D)	25	45.7	66	66
	MC-75a(D)	29.7	54	78	78
	MC-85a(D)	35	60	92	92
	MC-100a(D)	37	62	94	94

Note) - When the switch is closed condenser must be discharged before recharged. (Maximum residual voltage at terminals $\leq 50V$)
 - To prevent short current, gG type fuse must be 1.5~2 times than rated current.

Features of capacitor unit (Pre-loading resistor)

- Damping resistor that can limit the inrush current upto $60 \times I_n$ is connected to the mechanism that closed earlier than the main contact of the contactor
- No heat loss by the serial resistor
- Eliminate the switching surge
- Improving the performance of the capacitor system

Operation sequence

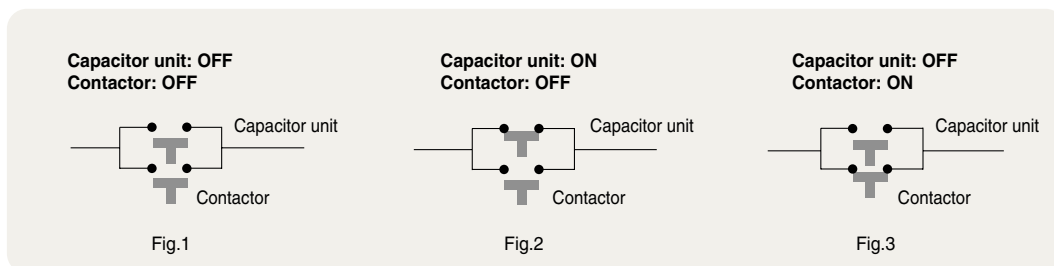

Note) Closing sequence: Fig.1 => Fig.2 => Fig.3
 Opening sequence: Fig.3 => Fig.1

Replacement coils

To replace the existing coil to change voltage or repair.

Contactor	Coil voltage							
	AC coil						DC coil	
	AC 60Hz (V)		AC 50Hz (V)		AC 50/60Hz (V)		DC (V)	
MC-6a MC-9a MC-12a MC-18a	24	230	24	230	24	240	12	110
	48	240	36	240	48	380	20	125
	100	277	42	380	100	415	24	200
	110	380	48	400	110	440	48	220
	120	440	80	415	120	500	60	250
	200	480	100	440	200	550	80	
	208	600	110	500	220		100	
	220		220	550	230			
MC-9b MC-12b MC-18b MC-22b	24	230	24	230	24	240	12	110
	48	240	36	240	48	380	20	125
	100	277	42	380	100	415	24	200
	110	380	48	400	110	440	48	220
	120	440	80	415	120	500	60	250
	200	480	100	440	200	550	80	
	208	600	110	500	220		100	
	220		220	550	230			
MC-32a MC-40a	24	230	24	230	24	240	12	110
	48	240	36	240	48	380	20	125
	100	277	42	380	100	415	24	200
	110	380	48	400	110	440	48	220
	120	440	80	415	120	500	60	250
	200	480	100	440	200	550	80	
	208	600	110	500	220		100	
	220		220	550	230			
MC-50a MC-65a	24	230	24	230	24	240	12	110
	48	240	36	240	48	380	20	125
	100	277	42	380	100	415	24	200
	110	380	48	400	110	440	48	220
	120	440	80	415	120	500	60	250
	200	480	100	440	200	550	80	
	208	600	110	500	220		100	
	220		220	550	230			
MC-75a MC-85a MC-100a	24	230	24	230	24	240	12	110
	48	240	36	240	48	380	20	125
	100	277	42	380	100	415	24	200
	110	380	48	400	110	440	48	220
	120	440	80	415	120	500	60	250
	200	480	100	440	200	550	80	
	208	600	110	500	220		100	
	220		220	550	230			
MC-130a MC-150a					24	300	24	110
					48	400	48	220
					110	500		
					220			



Replacement process

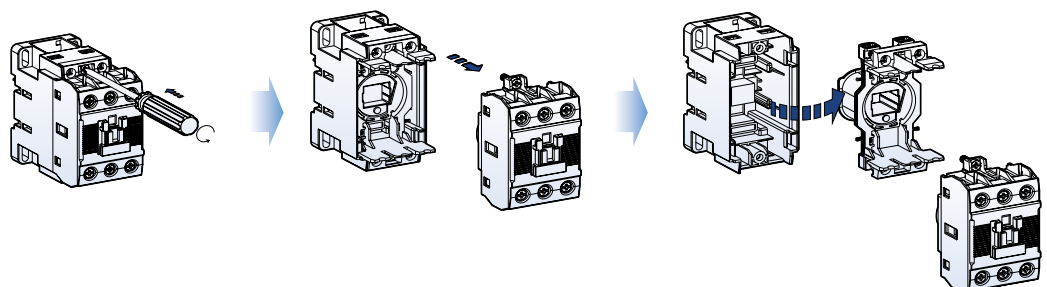

To replace the existing coil to change voltage or repair.



Contactor	Coil voltage	
	AC/DC common coil	AC coil
MC-185a MC-225a	24 48 100~240/100~220	300 400 500
MC-265a MC-300a MC-400a	100~240/100~220	300 400 500
MC-500a MC-630a MC-800a	100/100 200/200	300 400 500

Safety cover (Option)

- To prevent arc from coming out from the contactor
- To protect from unintended manual operation
- To prevent dust from entering into the inside of the contactor



Type	Contactor
AP-9	All types

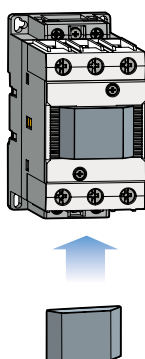

General descriptions

Type MT, bimetal-style, overload relays are designed to protect AC circuits and motors against overloads, phase failure, long starting times and prolonged stalling of the motor.

Four versions are available according to the protection function and trip class as below.

1. Non-differential: 3pole-2bimetal(heater) and trip class 10A
2. Non-differential: 3pole-3bimetal(heater) and trip class 10A
3. Differential: 3pole-3bimetal(heater) and trip class 10A
4. Differential: 3pole-3bimetal(heater) and trip class 20

Configuration of the front

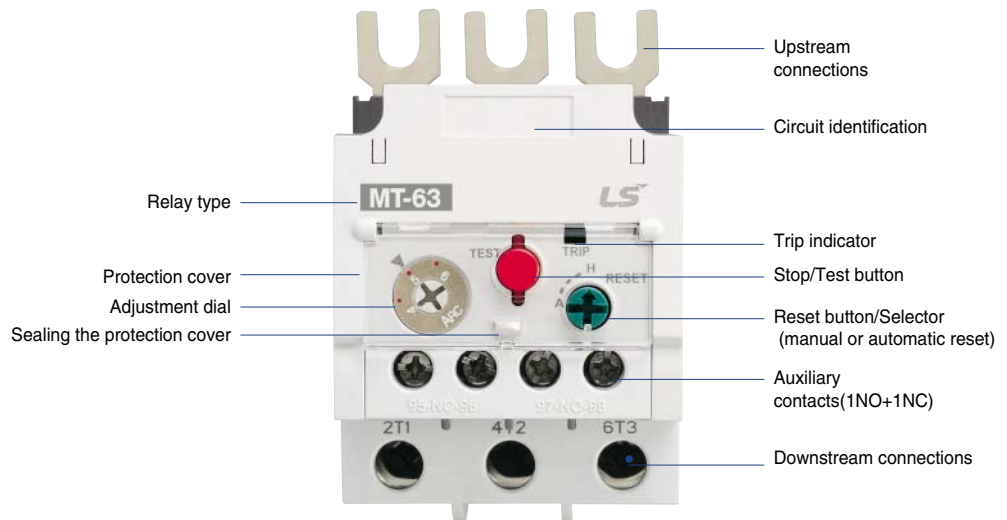

Environment and auxiliary circuit

Environment		MT-12-150	MT-225-800
Standards		IEC/EN 60947-1, IEC/EN 60947-4-1	IEC/EN 60947-1, IEC/EN 60947-4-1
Certifications		CE, CSA, UL	CE, CSA, UL
Rated operation voltage		Max. 690V	Max. 690V
Rated insulation voltage		690V	690V
Rated frequency		50/60Hz	50/60Hz
Degree of protection (Conforming to IEC 60 529)		IP 20	IP 20
Ambient air temperature	Storage	-55 ~ +80° C	-55 ~ +80° C
	Operation	-5 ~ +60° C	-5 ~ +60° C
Mounting position		Vertical plane	Vertical plane
Shock resistance (Conforming to IEC 68-2-7)		15gn - 11ms	15gn - 11ms
Vibration resistance (Conforming to IEC68-2-6)		6G	6G
Insulation strength (Conforming to IEC 255-5)		6kV	6kV
Rated impulse withstand voltage (Conforming to IEC 801-5)		6kV	6kV
Auxiliary contacts characteristics			
Composition		1a1b (1NO +1NC)	1NO+1NC
Rated thermal current		5A	5A
Rated operation current		C600, R300	C600, R300
AC15 duty (C600)	120V	1.5A	2.5A
	240V	0.75A	2A
	380V	0.47A	0.47A
	480V	0.375A	0.375A
	500V	0.35A	0.35A
	600V	0.3A	1A
DC13 duty (R300)	120V	0.22A	0.28A
	240V	0.1A	0.14A
Connecting conductor	Size	18AWG /1 mm ²	18AWG /1 mm ²
Connection to screw clamp terminals	Type	65/75° C Cu-wire	65/75° C Cu-wire

MT-150



MT-225



MT-400



MT-800



Overload relay specifications

MT type Thermal Overload Relays

Metasol



MT-12/3K□

Frame size		
Trip class		
Type	Non-differential(3P-2 heater) Non-differential(3P-3 heater) Differential type	
Terminal type		
Number of poles		
Rated operational voltage (Ue)		
Rated insulation voltage (Ui)		
Rated impulse voltage (Uimp)		
Degree of protection (IEC 60 529)		
Temperature compensation (° C)		
Functions	Trip indicating Stop Test Manual/Automatic Reset	
Setting range(A)		
Nominal current rating	Wire size	
	mm ²	AWG
0.14	1	18
0.21		
0.33		
0.52		
0.82		
1.3		
2.1		
3.3		
5		
6.5		
7.5	1~1.5	18~16
8.5	1.5~2.5	16~14
15	2.5	14~12
19	2.5~4	12~10
21.5		
27	4~6	10
30	4~10	10~8
34	6~10	10~8
42	10	8
54		
65	16~25	6~4
74		
83	25~35	4~3
90		
Applied contactors		
Separate mounting unit		

18AF	
10A	20
MT-12/2H□	-
MT-12/3H□	-
MT-12/3K□	MT-12/3D□
Screw clamp	
3	
690V	
Up to 690V	
6kV	
IP 20	
-5~+40°C	
■	
-	
■	
■	
0.1~18A	1~18A
0.1~0.16	
0.16~0.25	
0.25~0.4	
0.4~0.63	
0.63~1	
1~1.6	1~1.6
1.6~2.5	1.6~2.5
2.5~4	2.5~4
4~6	4~6
5~8	5~8
6~9	6~9
7~10	7~10
9~13	9~13
12~18	12~18
MC-6a, 9a, 12a, 18a	
-	



MT-32/3K□

40AF

10A	20
MT-32/2H□	-
MT-32/3H□	-
MT-32/3K□	MT-32/3D□
Screw clamp	
3	
690V	
Up to 690V	
6kV	
IP 20	
-5~+40°C	
■	
■	
■	
■	
■	
0.1~40A	1~40A
0.1~0.16	
0.16~0.25	
0.25~0.4	
0.4~0.63	
0.63~1	
1~1.6	1~1.6
1.6~2.5	1.6~2.5
2.5~4	2.5~4
4~6	4~6
5~8	5~8
6~9	6~9
7~10	7~10
9~13	9~13
12~18	12~18
16~22	16~22
18~25	18~25
22~32	22~32
-	-
28~40	28~40
MC-9b, 12b, 18b, 22b, 32a, 40a	
UZ-32	



MT-63/3K□S

65AF

10A	20
MT-63/2H□S	-
MT-63/3H□S	-
MT-63/3K□S	MT-63/3D□S
Screw clamp	
3	
690V	
Up to 690V	
6kV	
IP 20	
-5~+40°C	
■	
■	
■	
■	
■	
4~65A	
4~6	4~6
5~8	5~8
6~9	6~9
7~10	7~10
9~13	9~13
12~18	12~18
16~22	16~22
18~25	18~25
-	-
24~36	24~36
28~40	28~40
34~50	34~50
45~65	45~65
MC-50a, 65a	
UZ-63/S	



MT-95/3K□S

100AF

10A	20
MT-95/2H□S	-
MT-95/3H□S	-
MT-95/3K□S	MT-95/3D□S
Screw clamp	
3	
690V	
Up to 690V	
6kV	
IP 20	
-5~+40°C	
■	
■	
■	
■	
■	
7~100A	
7~10	7~10
9~13	9~13
12~18	12~18
16~22	16~22
18~25	18~25
-	-
24~36	24~36
28~40	28~40
34~50	34~50
45~65	45~65
54~75	54~75
63~85	63~85
70~95	70~95
80~100	80~100
MC-75a, 85a, 100a	
UZ-95/S	

Overload relay specifications

MT type Thermal Overload Relays

Metasol



Frame size		
Trip class		
Type	Non-differential(3P-2 heater)	
	Non-differential(3P-3 heater)	
	Differential type	
Terminal type		
Number of poles		
Rated operational voltage (Ue)		
Rated insulation voltage (Ui)		
Rated impulse voltage (Uimp)		
Degree of protection (IEC 60 529)		
Temperature compensation (°C)		
Functions	Trip indicating	
	Stop	
	Test	
	Manual/Automatic Reset	
Setting range(A)		
Nominal current rating	Wire size	
	mm ²	AWG
42	10	8
55	16	6
65	25	4
74	25	4
80	35	3
93	35	2
107	50	1
113	50	1
130	50	0
130	70	00
153	95	000
200	120	250
265	185	350
350	240	500
515	185 × 2n	350 × 2n
660	240 × 2n	300 × 3n
Applied contactors		
Separate mounting unit		

150AF	
10A	20
MT-150/2H□	-
MT-150/3H□	-
MT-150/3K□	MT-150/3D□
Screw clamp	
3	
690V	
690V	
6kV	
IP 20	
-5~+40°C	
■	
■	
■	
■	
34~150A	34~150A
34~50	
45~65	
54~75	
63~85	
-	
80~105	
-	
95~130	
110~150	
MC-130a, 150a	
UZ-150/S	



225AF

10A	20
MT-225/2H□	-
MT-225/3H□	-
MT-225/3K□	MT-225/3D□

Screw clamp	
3	
690V	
690V	
6kV	
IP 20	
-5~+40°C	
■	
■	
■	
■	

65~240A	65~240A
---------	---------

65~100
-
85~125
-
-
100~160
120~185
160~240

MC-185a, 225a
-

400AF

10A	20
MT-400/2H□S	-
MT-400/3H□S	-
MT-400/3K□S	MT-400/3D□S

Screw clamp	
3	
690V	
690V	
6kV	
IP 20	
-5~+40°C	
■	
■	
■	
■	

85~400A	85~400A
---------	---------

85~125
-
-
100~160
120~185
160~240
200~330
260~400

MC-265a, 330a, 400a
-

800AF

10A	20
MT-800/2H□S	-
MT-800/3H□S	-
MT-800/3K□S	MT-800/3D□S

Screw clamp	
3	
690V	
690V	
6kV	
IP 20	
-5~+40°C	
■	
■	
■	
■	

200~800A	200~800A
----------	----------

200~300
260~400
400~600
520~800

MC-500a, 630a, 800a
-

Overload relay operation

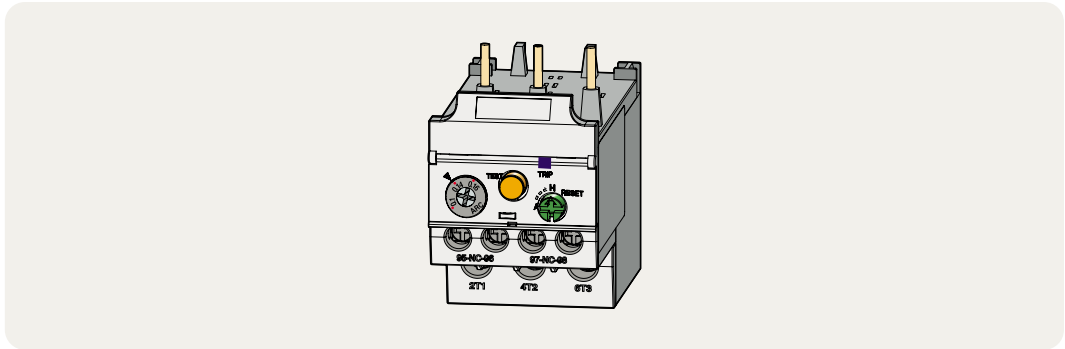
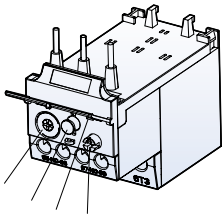

1. Adjustment dial



Before adjusting the dial open the protection cover.
Current setting can be done easily by using (+) or (-) driver.
Do not rotate the dial out of the setting range.

2. Stop/Test button

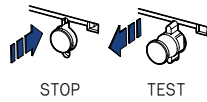

STOP function is executed by pushing the button, which causes the next sequence.
In case of operation test pull this button.

3. Trip indicator

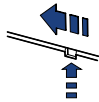

If relay is tripped it comes out.

4. Reset button/Selector

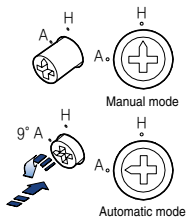

Using a driver the reset mode can be set.
In case of Manual mode(H) push the button to reset the relay.
To change to Automatic mode(A) from Manual mode push the button and rotate as shown in the fig.

5. Auxiliary contact operation

Terminal no.	Normal	STOP	TEST/TRIP	RESET
NC 95-96				
NO 97-98				

Accessories for overload relay

Separate mounting units

These accessories are used to mount the relays separately from contactors. If a relay is combined with a unit, it can be mounted on DIN rail or panel by fixing screws.



Relay	Unit	
	Type	Weight
MT-32/2H□ MT-32/3H□ MT-32/3K□ MT-32/3D□	UZ-32	38g
MT-63/2H□S MT-63/3H□S MT-63/3K□S MT-63/3D□S	UZ-63/S	134g
MT-95/2H□S MT-95/3H□S MT-95/3K□S MT-95/3D□S	UZ-95/S	230g
MT-150/2H□ MT-150/3H□ MT-150/3K□ MT-150/3D□	UZ-150/S	284g

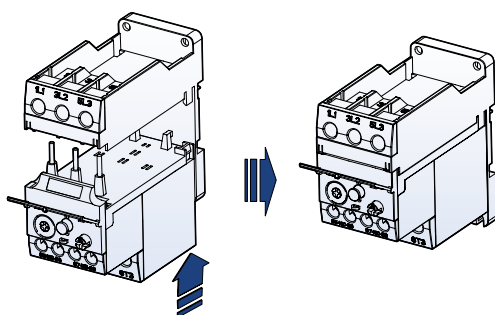

Terminal cover units for overload relays



Relay	Unit type	Remarks
MT-225	APT-225	2 pcs included
MT-400	APT-400	
MT-800	APT-600	

Accessories for overload relay

Remote reset units

These accessories are used to reset the relays on the panel door.



Type	Cable length (L)
UM-4R	400 mm
UM-5R	500 mm
UM-6R	600 mm

1. Make the reset bar straight at least 55mm from the panel door and 35mm from the bracket.
2. The bending radius of the flexible reset bar should not be less than 15mm.

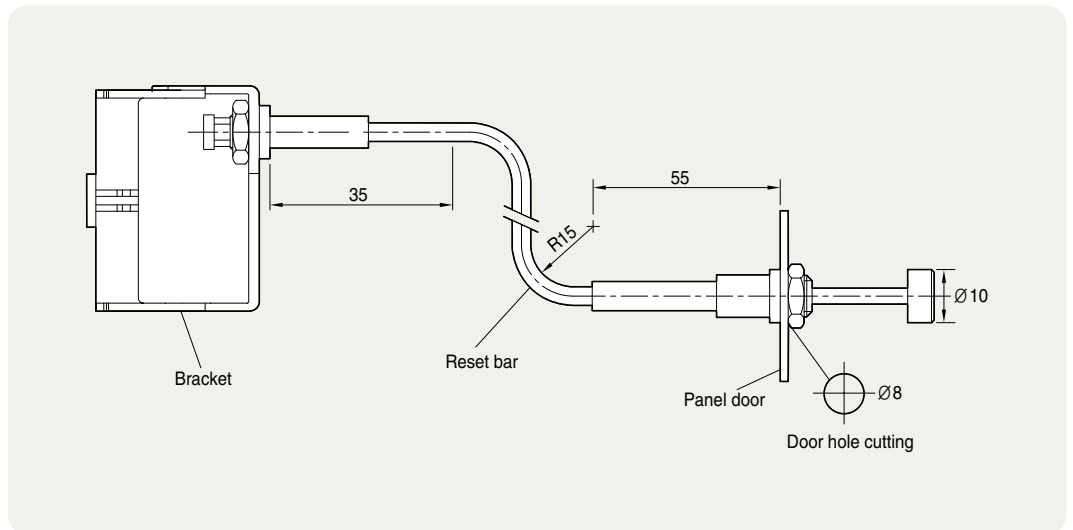

Installation

1. Fit the bracket with the relay as indicated(*1) below.
2. Separate Nut(*3) and Head cap(*4) from the reset bar first.
Insert the reset bar into the panel hole and then fix it with the Nut and Head.
3. To separate the bracket from the relay lift the *2 part as shown in the fig.

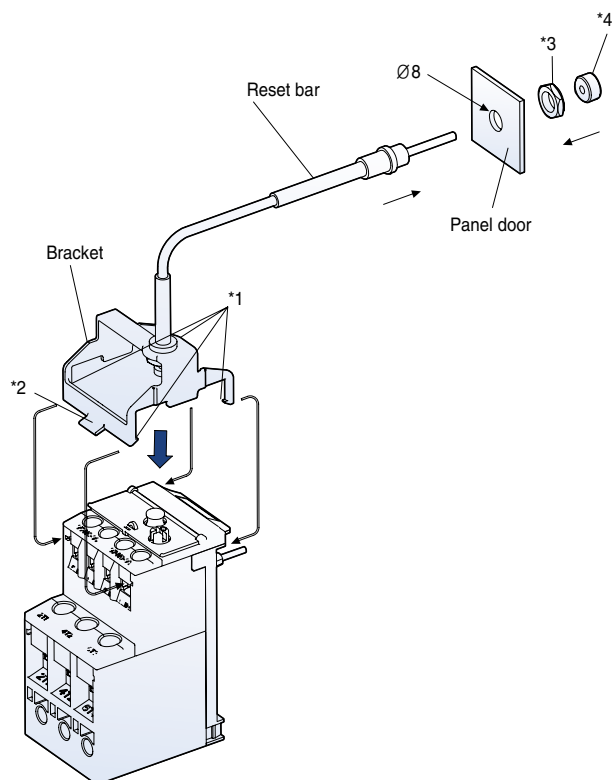
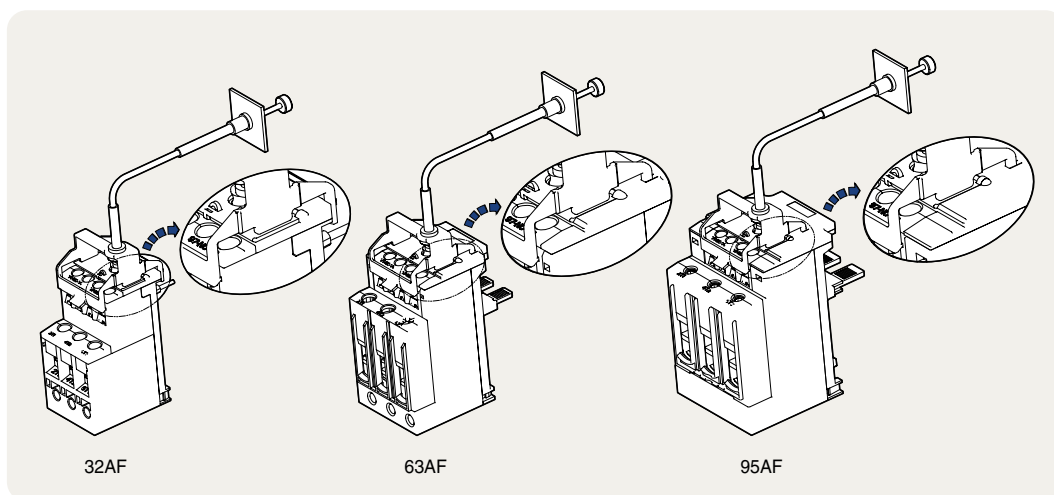

Overload relay ordering types

Trip class 10A

Direct mounting type



MT-12/□

Setting range (A)	Ordering type			Contactor	Separate mounting unit
	Non-differential (3P-2 heater)	Non-differential (3P-3 heater)	Differential		
0.1~0.16	MT-12/2H0.14	MT-12/3H0.14	MT-12/3K0.14	MC-6a MC-9a MC-12a MC-18a	
0.16~0.25	MT-12/2H0.21	MT-12/3H0.21	MT-12/3K0.21		
0.25~0.4	MT-12/2H0.33	MT-12/3H0.33	MT-12/3K0.33		
0.4~0.63	MT-12/2H0.52	MT-12/3H0.52	MT-12/3K0.52		
0.63~1	MT-12/2H0.82	MT-12/3H0.82	MT-12/3K0.82		
1~1.6	MT-12/2H1.3	MT-12/3H1.3	MT-12/3K1.3		
1.6~2.5	MT-12/2H2.1	MT-12/3H2.1	MT-12/3K2.1		
2.5~4	MT-12/2H3.3	MT-12/3H3.3	MT-12/3K3.3		
4~6	MT-12/2H5	MT-12/3H5	MT-12/3K5		
5~8	MT-12/2H6.5	MT-12/3H6.5	MT-12/3K6.5		
6~9	MT-12/2H7.5	MT-12/3H7.5	MT-12/3K7.5		
7~10	MT-12/2H8.5	MT-12/3H8.5	MT-12/3K8.5		
9~13	MT-12/2H11	MT-12/3H11	MT-12/3K11		
12~18	MT-12/2H15	MT-12/3H15	MT-12/3K15		



MT-32/□

Setting range (A)	Ordering type			Contactor	Separate mounting unit
	Non-differential (3P-2 heater)	Non-differential (3P-3 heater)	Differential		
0.1~0.16	MT-32/2H0.14	MT-32/3H0.14	MT-32/3K0.14	MC-9b MC-12b MC-18b MC-22b MC-32a MC-40a	UZ-32
0.16~0.25	MT-32/2H0.21	MT-32/3H0.21	MT-32/3K0.21		
0.25~0.4	MT-32/2H0.33	MT-32/3H0.33	MT-32/3K0.33		
0.4~0.63	MT-32/2H0.52	MT-32/3H0.52	MT-32/3K0.52		
0.63~1	MT-32/2H0.82	MT-32/3H0.82	MT-32/3K0.82		
1~1.6	MT-32/2H1.3	MT-32/3H1.3	MT-32/3K1.3		
1.6~2.5	MT-32/2H2.1	MT-32/3H2.1	MT-32/3K2.1		
2.5~4	MT-32/2H3.3	MT-32/3H3.3	MT-32/3K3.3		
4~6	MT-32/2H5	MT-32/3H5	MT-32/3K5		
5~8	MT-32/2H6.5	MT-32/3H6.5	MT-32/3K6.5		
6~9	MT-32/2H7.5	MT-32/3H7.5	MT-32/3K7.5		
7~10	MT-32/2H8.5	MT-32/3H8.5	MT-32/3K8.5		
9~13	MT-32/2H11	MT-32/3H11	MT-32/3K11		
12~18	MT-32/2H15	MT-32/3H15	MT-32/3K15		
16~22	MT-32/2H19	MT-32/3H19	MT-32/3K19		
18~25	MT-32/2H21.5	MT-32/3H21.5	MT-32/3K21.5		
22~32	MT-32/2H27	MT-32/3H27	MT-32/3K27		
28~40	MT-32/2H34	MT-32/3H34	MT-32/3K34		

Trip class 10A

Direct mounting type



MT-63/□

Setting range (A)	Ordering type			Contactor	Separate mounting unit
	Non-differential (3P-2 heater)	Non-differential (3P-3 heater)	Differential		
4~6	MT-63/2H5S	MT-63/3H5S	MT-63/3K5S	MC-50a MC-65a	UZ-63/S
5~8	MT-63/2H6.5S	MT-63/3H6.5S	MT-63/3K6.5S		
6~9	MT-63/2H7.5S	MT-63/3H7.5S	MT-63/3K7.5S		
7~10	MT-63/2H8.5S	MT-63/3H8.5S	MT-63/3K8.5S		
9~13	MT-63/2H11S	MT-63/3H11S	MT-63/3K11S		
12~18	MT-63/2H15S	MT-63/3H15S	MT-63/3K15S		
16~22	MT-63/2H19S	MT-63/3H19S	MT-63/3K19S		
18~25	MT-63/2H21.5S	MT-63/3H21.5S	MT-63/3K21.5S		
24~36	MT-63/2H30S	MT-63/3H30S	MT-63/3K30S		
28~40	MT-63/2H34S	MT-63/3H34S	MT-63/3K34S		
34~50	MT-63/2H42S	MT-63/3H42S	MT-63/3K42S		
45~65	MT-63/2H55S	MT-63/3H55S	MT-63/3K55S		



MT-95/□

Setting range (A)	Ordering type			Contactor	Separate mounting unit
	Non-differential (3P-2 heater)	Non-differential (3P-3 heater)	Differential		
7~10	MT-95/2H8.5S	MT-95/3H8.5S	MT-95/3K8.5S	MC-75a MC-85a MC-100a	UZ-95/S
9~13	MT-95/2H11S	MT-95/3H11S	MT-95/3K11S		
12~18	MT-95/2H15S	MT-95/3H15S	MT-95/3K15S		
16~22	MT-95/2H19S	MT-95/3H19S	MT-95/3K19S		
18~25	MT-95/2H21.5S	MT-95/3H21.5S	MT-95/3K21.5S		
24~36	MT-95/2H30S	MT-95/3H30S	MT-95/3K30S		
28~40	MT-95/2H34S	MT-95/3H34S	MT-95/3K34S		
34~50	MT-95/2H42S	MT-95/3H42S	MT-95/3K42S		
45~65	MT-95/2H55S	MT-95/3H55S	MT-95/3K55S		
54~75	MT-95/2H65S	MT-95/3H65S	MT-95/3K65S		
63~85	MT-95/2H74S	MT-95/3H74S	MT-95/3K74S		
70~95	MT-95/2H83S	MT-95/3H83S	MT-95/3K83S		
80~100	MT-95/2H90S	MT-95/3H90S	MT-95/3K90S		

Overload relay ordering types

Trip class 10A



MT-150



MT-150/□

Setting range (A)	Ordering type			Contactor	Separate mounting unit
	Non-differential		Differential		
	(3P-2 heater)	(3P-3 heater)			
34~50	MT-150/2H42	MT-150/3H42	MT-150/3K42	MC-130a MC-150a	UZ-150/S
45~65	MT-150/2H55	MT-150/3H55	MT-150/3K55		
54~75	MT-150/2H65	MT-150/3H65	MT-150/3K65		
63~85	MT-150/2H74	MT-150/3H74	MT-150/3K74		
80~105	MT-150/2H93	MT-150/3H93	MT-150/3K93		
95~130	MT-150/2H113	MT-150/3H113	MT-150/3K113		
110~150	MT-150/2H130	MT-150/3H130	MT-150/3K130		

MT-225



MT-225/□

Setting range (A)	Ordering type			Contactor	Remarks
	Non-differential		Differential		
	(3P-2 heater)	(3P-3 heater)			
65~100	MT-225/2H80	MT-225/3H80	MT-225/3K80	MC-185a MC-225a	-
85~125	MT-225/2H107	MT-225/3H107	MT-225/3K107		
100~160	MT-225/2H130	MT-225/3H130	MT-225/3K130		
120~185	MT-225/2H153	MT-225/3H153	MT-225/3K153		
160~240	MT-225/2H200	MT-225/3H200	MT-225/3K200		

MT-400



MT-400/□

Setting range (A)	Ordering type			Contactor	Remarks
	Non-differential		Differential		
	(3P-2 heater)	(3P-3 heater)			
85~125	MT-400/2H107	MT-400/3H107	MT-400/3K107	MC-265a MC-330a MC-400a	-
100~160	MT-400/2H130	MT-400/3H130	MT-400/3K130		
120~185	MT-400/2H153	MT-400/3H153	MT-400/3K153		
160~240	MT-400/2H200	MT-400/3H200	MT-400/3K200		
200~330	MT-400/2H265	MT-400/3H265	MT-400/3K265		
260~400	MT-400/2H350	MT-400/3H350	MT-400/3K350		

MT-800



MT-800/□

Setting range (A)	Ordering type			Contactor	Remarks
	Non-differential		Differential		
	(3P-2 heater)	(3P-3 heater)			
200~330	MT-800/2H265	MT-800/3H265	MT-800/3K265	MC-500a MC-630a MC-800a	-
260~400	MT-800/2H350	MT-800/3H350	MT-800/3K350		
400~630	MT-800/2H515	MT-800/3H515	MT-800/3K515		
520~800	MT-800/2H660	MT-800/3H660	MT-800/3K660		

Trip class 20

Direct mounting type



MT-12/3D□

Setting range (A)	Ordering type	Contactor	Separate mounting unit
	Differential		
1~1.6	MT-12/3D1.3	MC-6a MC-9a MC-12a MC-18a	-
1.6~2.5	MT-12/3D2.1		
2.5~4	MT-12/3D3.3		
4~6	MT-12/3D5		
5~8	MT-12/3D6.5		
6~9	MT-12/3D7.5		
7~10	MT-12/3D8.5		
9~13	MT-12/3D11		
12~18	MT-12/3D15		



MT-32/3D□

Setting range (A)	Ordering type	Contactor	Separate mounting unit
	Differential		
1~1.6	MT-32/3D1.3	MC-9b MC-12b MC-18b MC-22b MC-32a MC-40a	UZ-32
1.6~2.5	MT-32/3D2.1		
2.5~4	MT-32/3D3.3		
4~6	MT-32/3D5		
5~8	MT-32/3D6.5		
6~9	MT-32/3D7.5		
7~10	MT-32/3D8.5		
9~13	MT-32/3D11		
12~18	MT-32/3D15		
16~22	MT-32/3D19		
18~25	MT-32/3D21.5		
22~32	MT-32/3D27		
28~40	MT-32/3D34		
			UZ-32(34A)

Overload relay ordering types

Trip class 20

Direct mounting type



MT-63/3D□S

Setting range (A)	Ordering type	Contactor	Separate mounting unit
	Differential		
4~6	MT-63/3D5S	MC-50a MC-65a	UZ-63/S
5~8	MT-63/3D6.5S		
6~9	MT-63/3D7.5S		
7~10	MT-63/3D8.5S		
9~13	MT-63/3D11S		
12~18	MT-63/3D15S		
16~22	MT-63/3D19S		
18~25	MT-63/3D21.5S		
24~36	MT-63/3D30S		
28~40	MT-63/3D34S		
34~50	MT-63/3D42S		
45~65	MT-63/3D55S		



MT-95/3D□S

Setting range (A)	Ordering type	Contactor	Separate mounting unit
	Differential		
7~10	MT-95/3D8.5S	MC-75a MC-85a MC-100a	UZ-95/S
9~13	MT-95/3D11S		
12~18	MT-95/3DK15S		
16~22	MT-95/3D19S		
18~25	MT-95/3D21.5S		
24~36	MT-95/3D30S		
28~40	MT-95/3D34S		
34~50	MT-95/3D42S		
45~65	MT-95/3D55S		
54~75	MT-95/3D65S		
63~85	MT-95/3D74S		
70~95	MT-95/3D83S		
80~100	MT-95/3D90S		

Trip class 20



MT-150



MT-150/3D □

Setting range (A)	Ordering type	Contactor	Separate mounting unit
	Differential		
34~50	MT-150/3D42	MC-130a MC-150a	UZ-150/S
45~65	MT-150/3D55		
54~75	MT-150/3D65		
63~85	MT-150/3D74		
80~105	MT-150/3D93		
95~130	MT-150/3D113		
110~150	MT-150/3D130		

MT-225



MT-225/3D □

Setting range (A)	Ordering type	Contactor	Remarks
	Differential		
65~100	MT-225/3D80	MC-185a MC-225a	-
85~125	MT-225/3D107		
100~160	MT-225/3D130		
120~185	MT-225/3D153		
160~240	MT-225/3D200		

MT-400



MT-400/3D □

Setting range (A)	Ordering type	Contactor	Remarks
	Differential		
85~125	MT-400/3D107	MC-265a MC-330a MC-400a	-
100~160	MT-400/3D130		
120~185	MT-400/3D153		
160~240	MT-400/3D200		
200~330	MT-400/3D265		
260~400	MT-400/3D350		

MT-800



MT-800/3D □

Setting range (A)	Ordering type	Contactor	Remarks
	Differential		
200~330	MT-800/3D265	MC-500a MC-630a MC-800a	-
260~400	MT-800/3D350		
400~630	MT-800/3D515		
520~800	MT-800/3D660		

Overload relay trip curves

Class 10A, 18AF

- MT-12/2H
- MT-12/3H
- MT-12/3K

Cold starting

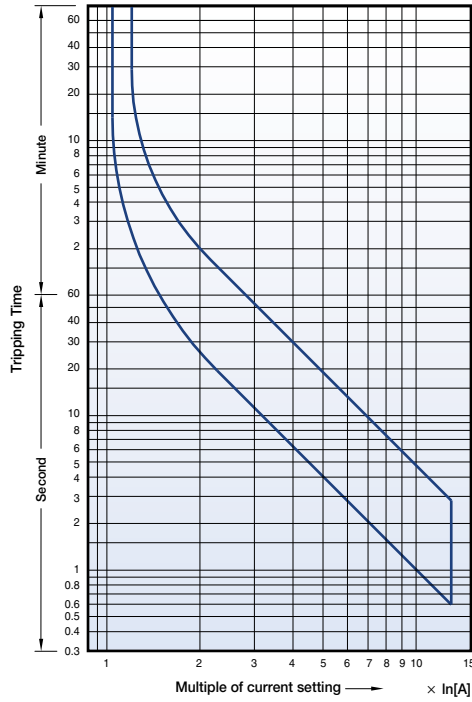

Hot starting

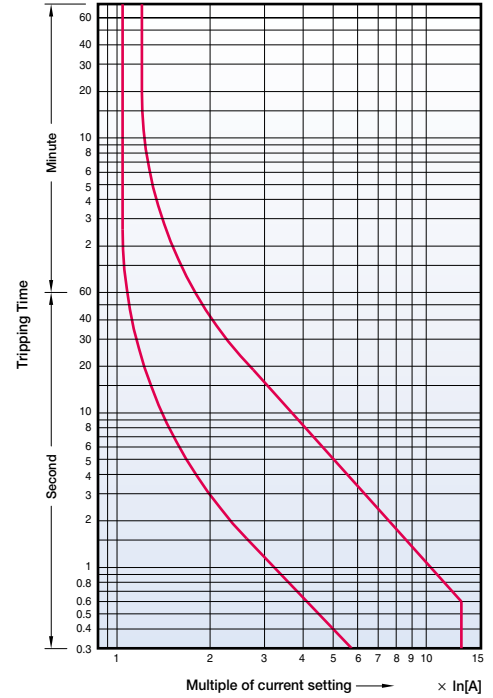

Class 20, 18AF

- MT-12/3D

Cold starting

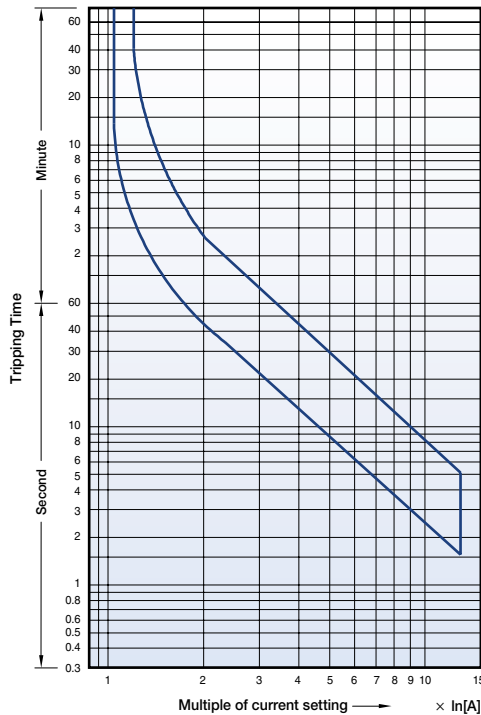

Hot starting

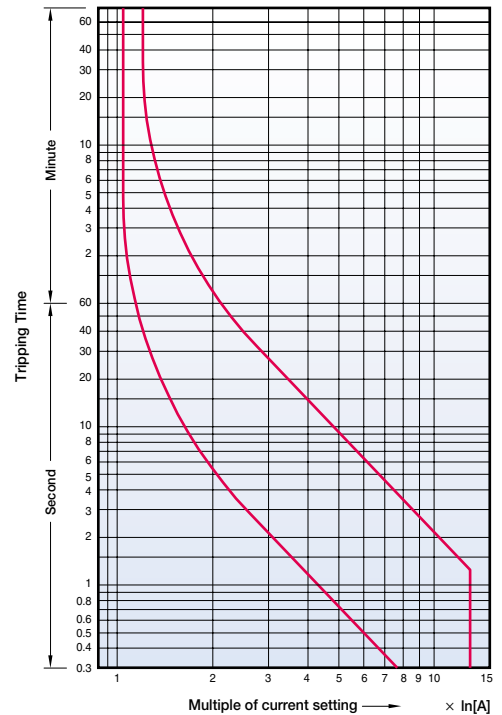

Class 10A, 40AF

- MT-32/2H
- MT-32/3H
- MT-32/3K

Cold starting

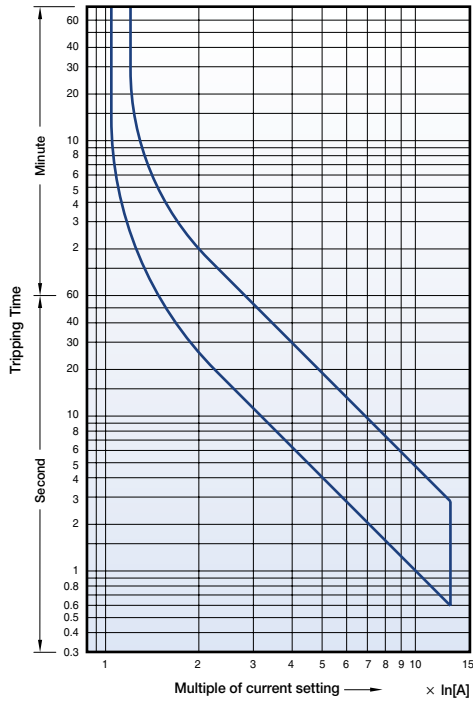

Hot starting

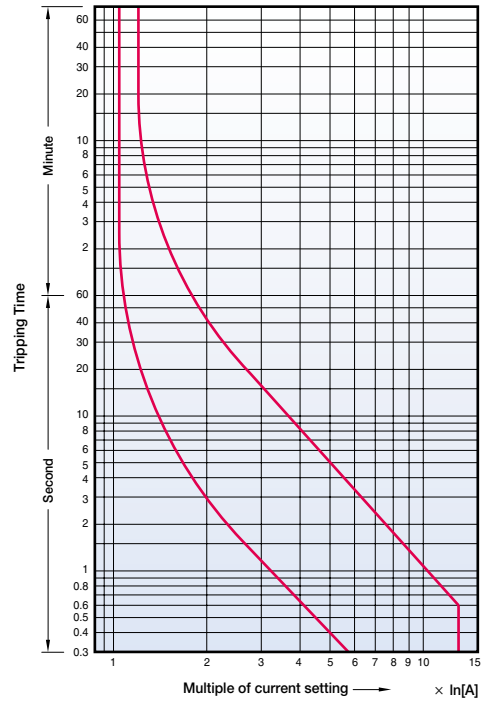

Class 20, 40AF

- MT-32/3D

Cold starting

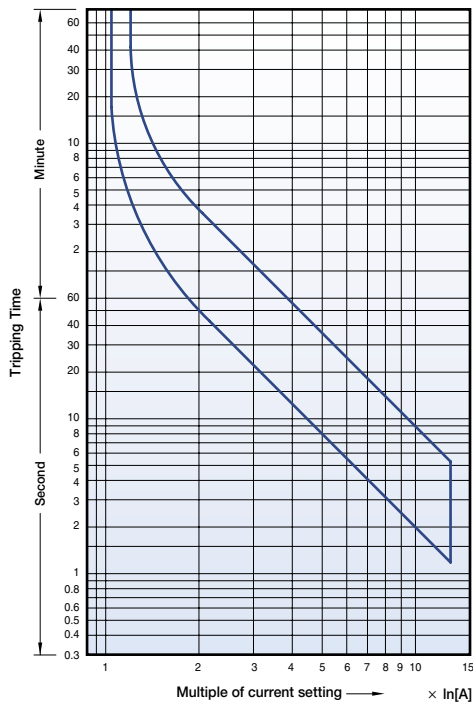

Hot starting

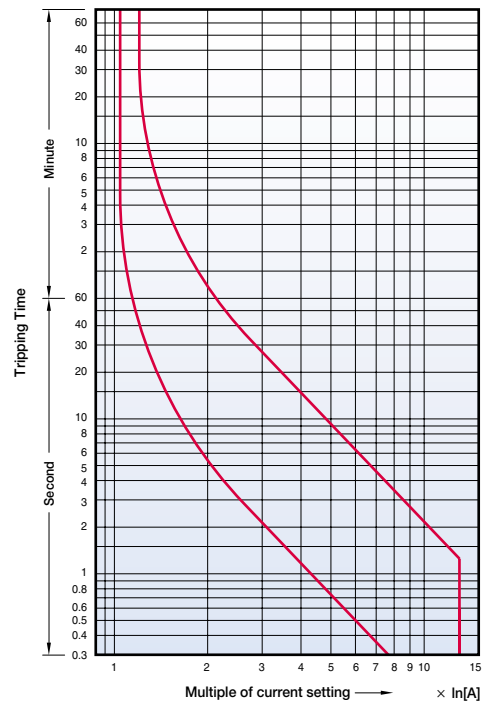

Overload relay trip curves

Metasol

Class 10A, 65AF

- MT-63/2H
- MT-63/3H
- MT-63/3K

Cold starting

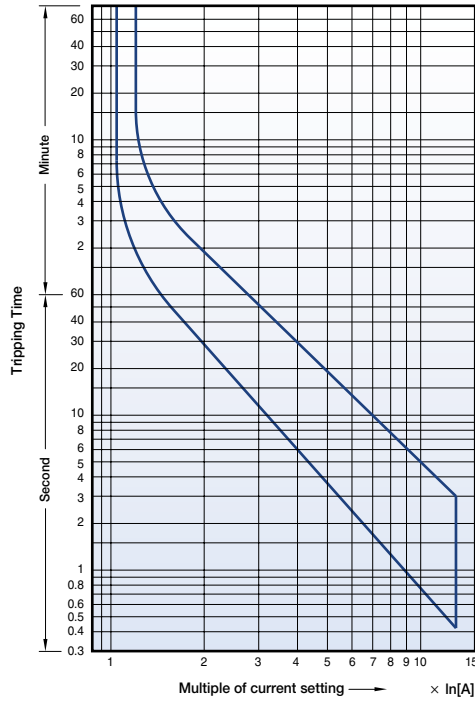

Hot starting

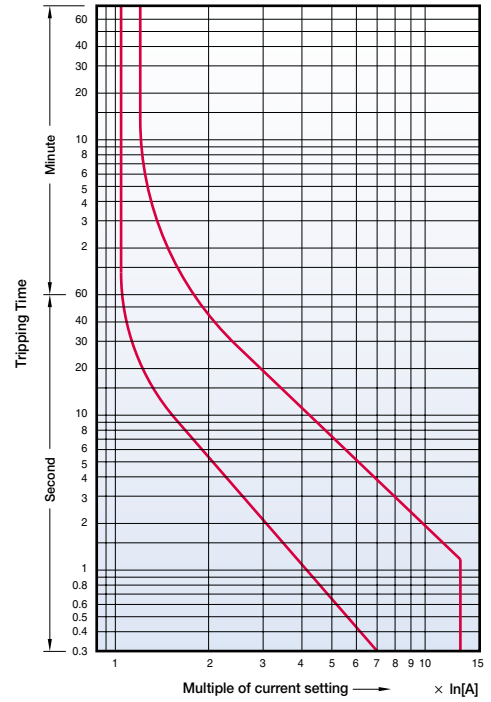

Class 20, 65AF

- MT-63/3D

Cold starting

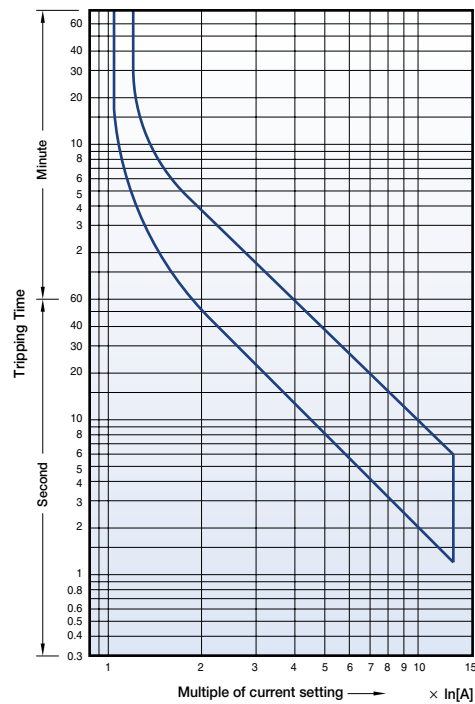

Hot starting

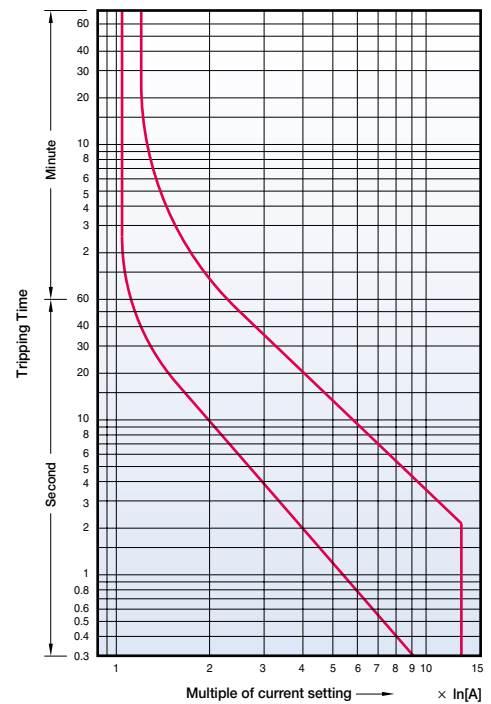

Class 10A, 100AF

- MT-95/2H
- MT-95/3H
- MT-95/3K

Cold starting

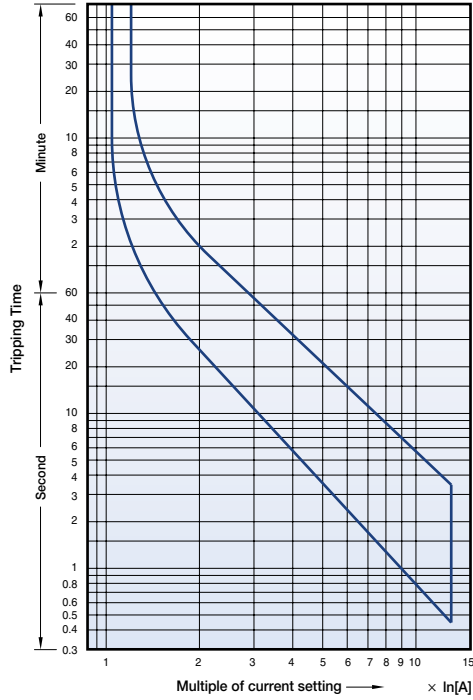

Hot starting

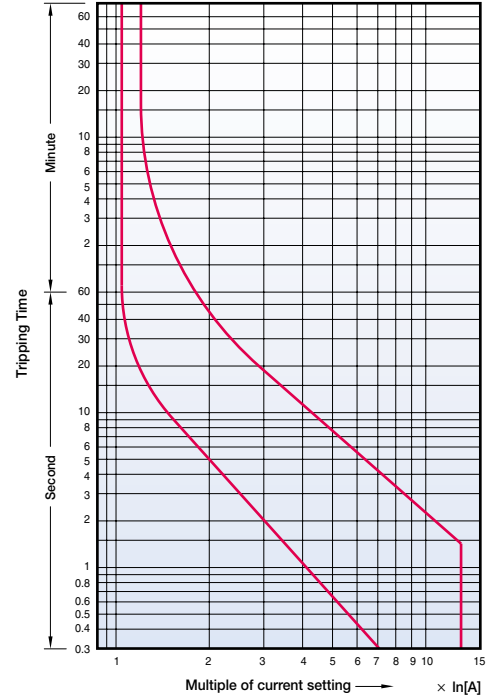

Class 20, 100AF

- MT-95/3D

Cold starting

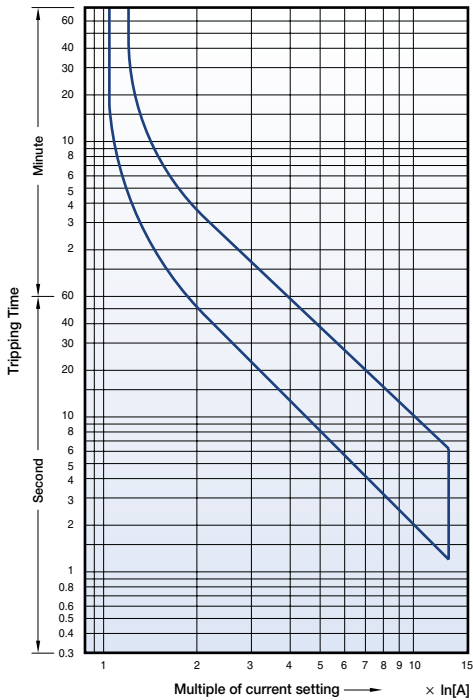

Hot starting

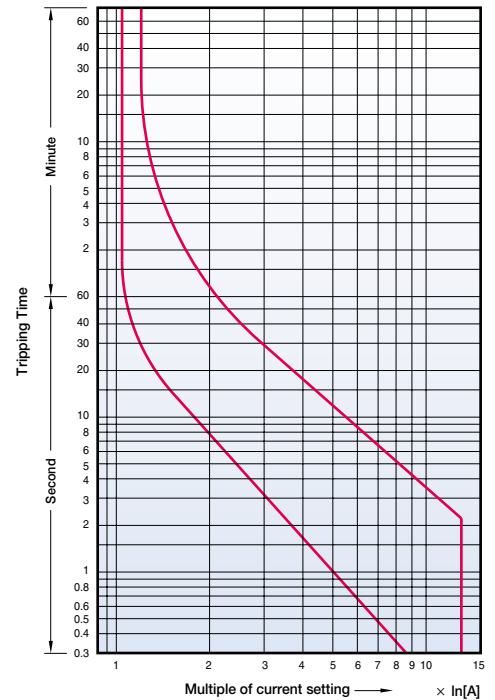

Overload relay trip curves

Class 10A, 150AF

- MT-150/2H
- MT-150/3H
- MT-150/3K

Cold starting

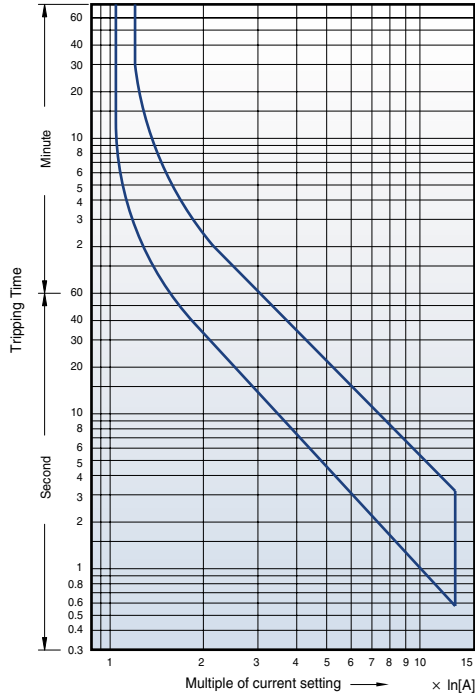

Hot starting

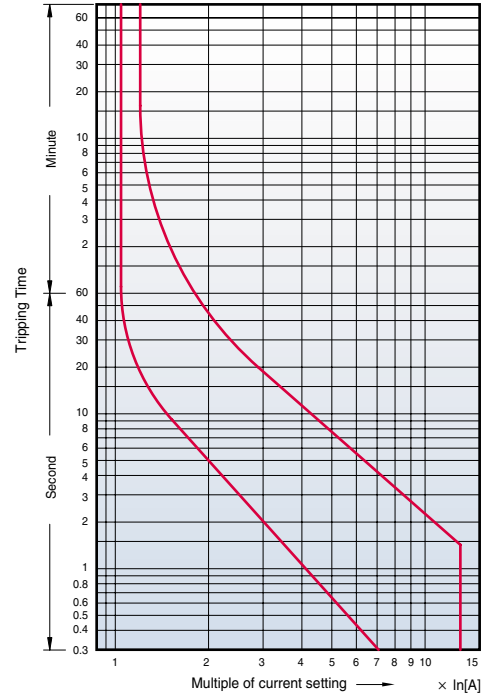

Class 20, 150AF

- MT-150/3D

Cold starting

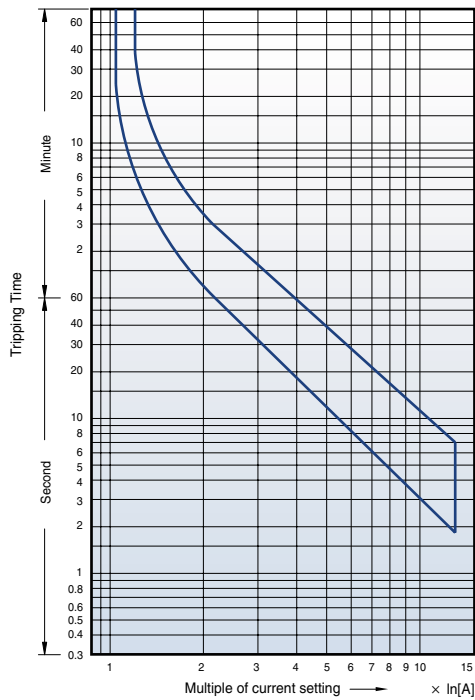

Hot starting

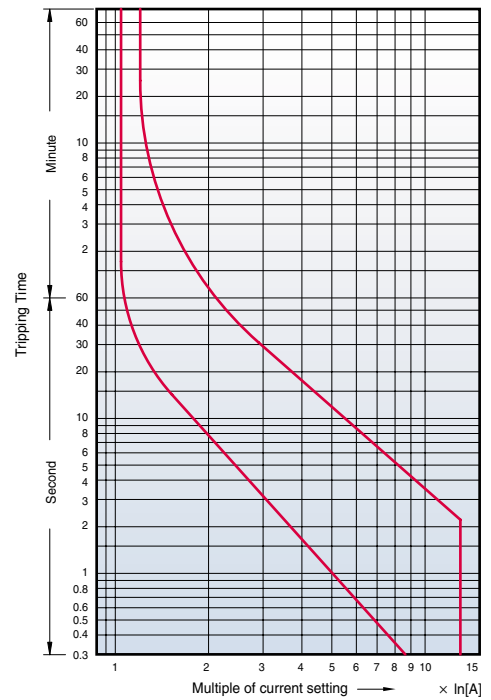

Class 10A, 225AF

- MT-225/2H
- MT-225/3H
- MT-225/3K

Cold starting

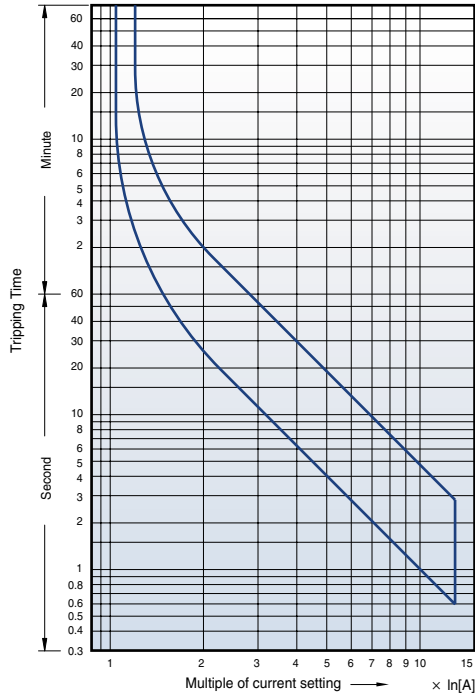

Hot starting

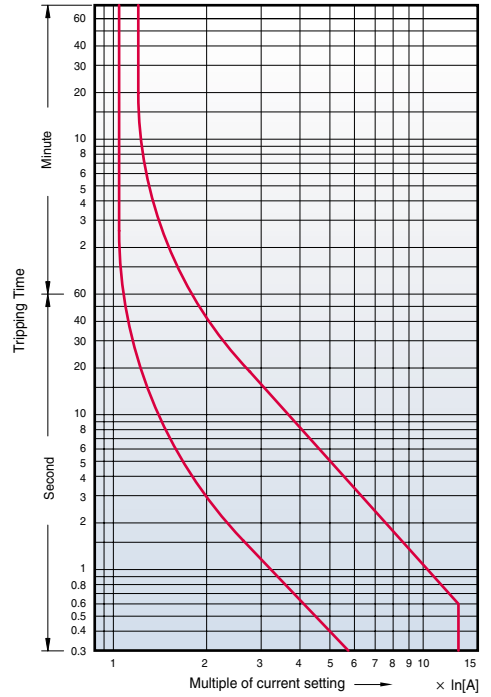

Class 20, 225AF

- MT-225/3D

Cold starting

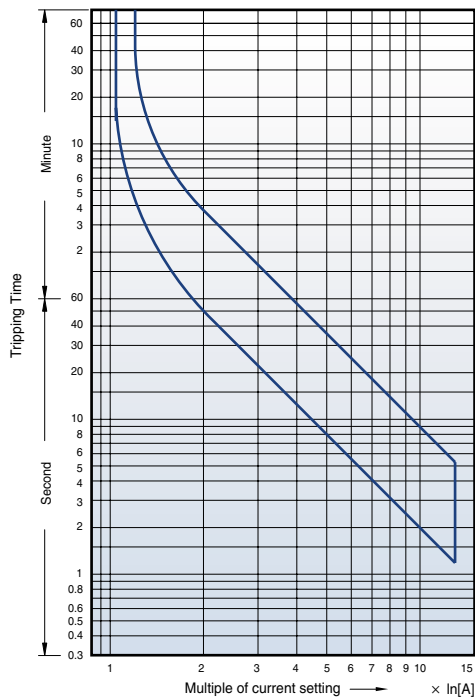

Hot starting

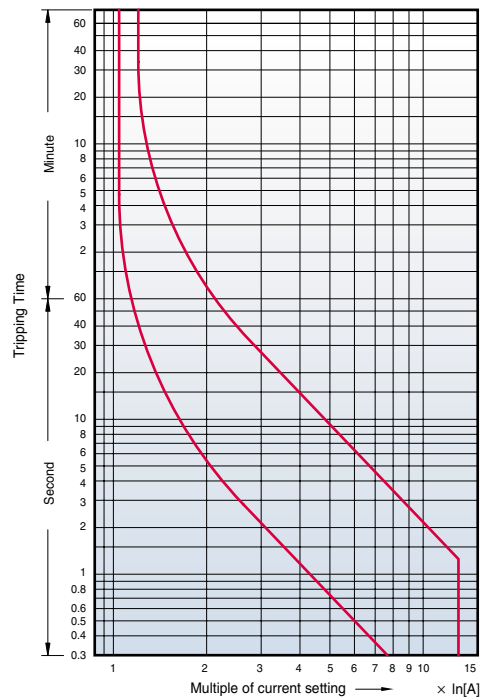

Overload relay trip curves

Metasol

Class 10A, 400AF

MT-400/2H

MT-400/3H

MT-400/3K

Cold starting

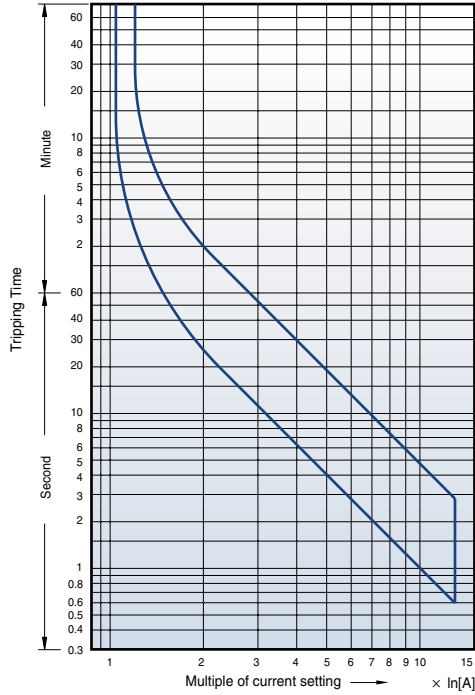

Hot starting

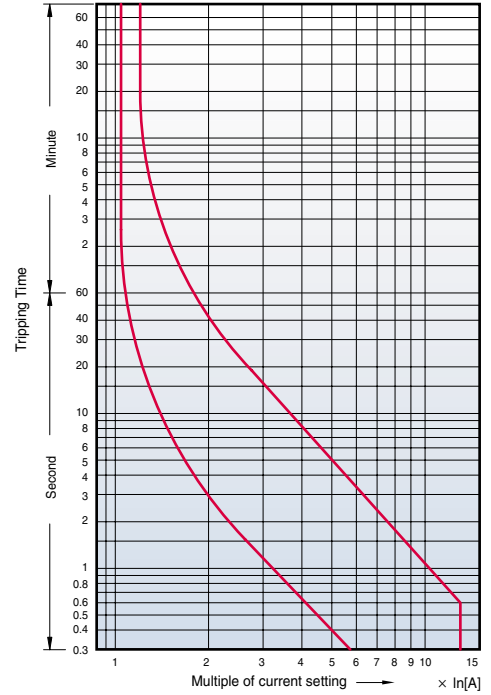

Class 20, 400AF

MT-400/3D

Cold starting

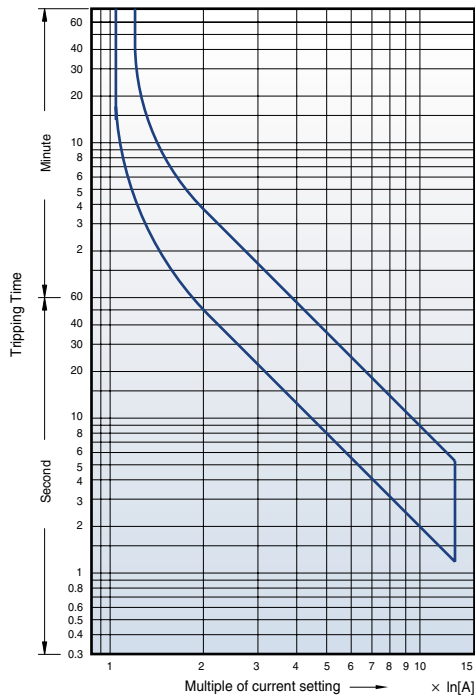

Hot starting

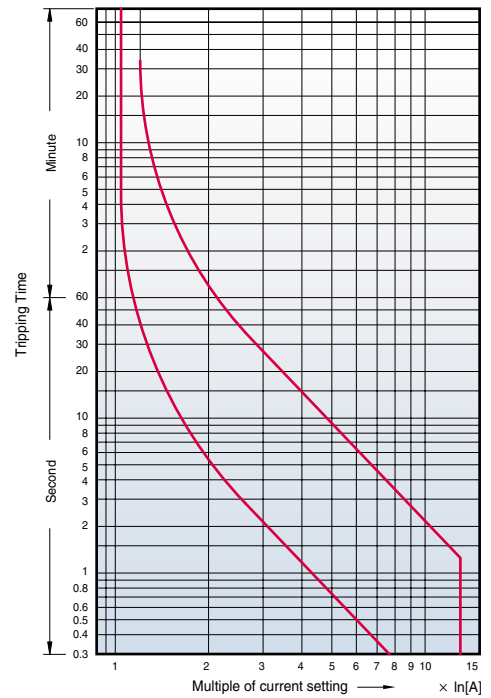

Class 10A, 800AF

- MT-800/2H
- MT-800/3H
- MT-800/3K

Cold starting

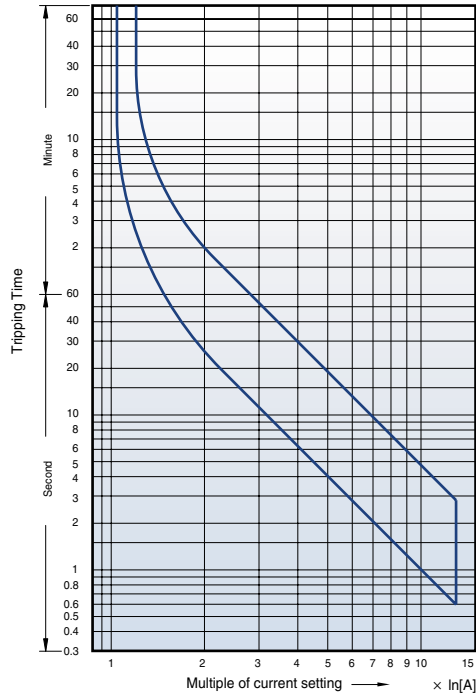

Hot starting

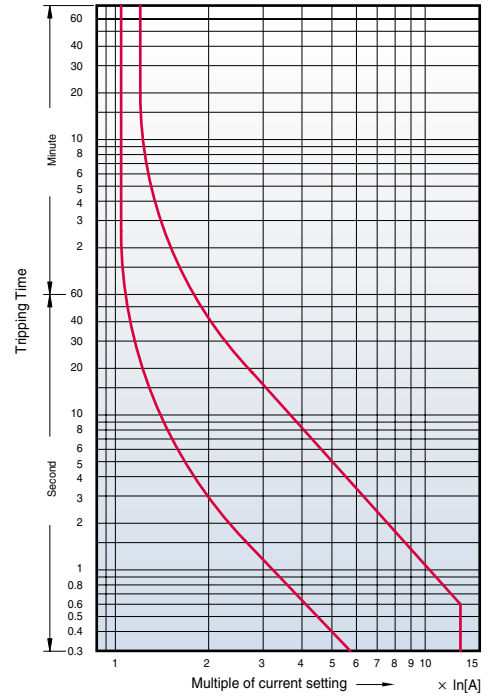

Class 20, 800AF

- MT-800/3D

Cold starting

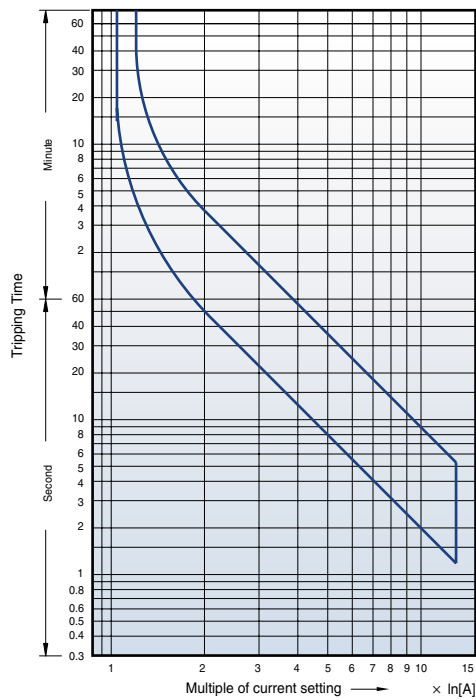

Hot starting

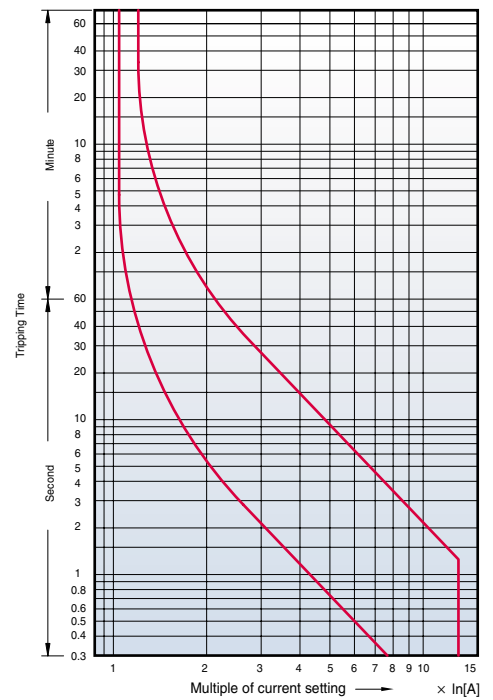

Type 2 Coordination (380/415V)

415V

HI type MMS + Susol MCCB

kW	Rated Operational Power			Circuit Breaker		Contactor	Thermal Overload Relays		Short Circuit Breaking Capacity	
	Current [A]			Type	Rating [A]	Type	Type	Setting Range [A]	Ir [kA]	Iq [kA]
	380V	400V	415V							
0.06	0.21	0.20	0.19	MMS-32HI	0.25	MC-6a	MT-12	0.16~0.25	1	50
0.09	0.32	0.30	0.29	MMS-32HI	0.4	MC-6a	MT-12	0.25~0.4	1	50
0.12	0.46	0.44	0.42	MMS-32HI	0.63	MC-6a	MT-12	0.4~0.63	1	50
0.18	0.63	0.60	0.58	MMS-32HI	0.63	MC-6a	MT-12	0.4~0.63	1	50
0.25	0.89	0.85	0.82	MMS-32HI	1	MC-6a	MT-12	0.63~1	1	50
0.37	1.16	1.10	1.06	MMS-32HI	1.6	MC-12a,12b	MT-12	1~1.6	1	50
0.55	1.6	1.5	1.4	MMS-32HI	1.6	MC-12a,12b	MT-12	1~1.6	1	50
0.75	2.0	1.9	1.8	MMS-32HI	2.5	MC-12a,12b	MT-12	1.6~2.5	1	50
1.1	2.8	2.7	2.6	MMS-32HI	4	MC-22b	MT-32	2.5~4	1	50
1.5	3.8	3.6	3.5	MMS-32HI	4	MC-22b	MT-32	2.5~4	1	50
2.2	5.2	4.9	4.7	MMS-32HI	6	MC-22b	MT-32	4~6	1	50
3.0	6.8	6.5	6.3	MMS-32HI	8	MC-40a	MT-32	5~8	1	50
4.0	8.9	8.5	8.2	MMS-32HI	10	MC-40a	MT-32	6~9	1	50
5.5	12.1	11.5	11.1	MMS-32HI	13	MC-40a	MT-32	9~13	3	50
7.5	16.3	15.5	14.9	MMS-32HI	17	MC-40a	MT-32	12~18	3	50
11.0	23.2	22.0	21.2	TD100	25	MC-50a	MT-63	18~25	3	70
15.0	31	29	28	TD100	32	MC-50a	MT-63	24~36	3	70
18.5	37	35	34	TD100	40	MC-50a	MT-63	28~40	3	70
22	43	41	40	TD100	50	MC-50a	MT-63	34~50	3	70
30	58	55	53	TD100	63	MC-65a	MT-63	45~65	3	70
37	69	66	64	TD100	80	MC-75a	MT-95	54~75	5	70
45	84	80	77	TD100	100	MC-85a	MT-95	63~85	5	70
55	-	-	93	TD100	100	MC-100a	MT-95	70~95	5	70

415V

H type MMS + Susol MCCB

Rated Operational Power				Circuit Breaker		Contactor	Thermal Overload Relays		Short Circuit Breaking Capacity	
kW	Current [A]			Type	Rating [A]	Type	Type	Setting Range [A]	Ir [kA]	Iq [kA]
	380V	400V	415V							
0.06	0.21	0.20	0.19	MMS-32H	0.25	MC-6a			1	50
0.09	0.32	0.30	0.29	MMS-32H	0.4	MC-6a			1	50
0.12	0.46	0.44	0.42	MMS-32H	0.63	MC-6a			1	50
0.18	0.63	0.60	0.58	MMS-32H	0.63	MC-6a			1	50
0.25	0.89	0.85	0.82	MMS-32H	1	MC-6a			1	50
0.37	1.16	1.10	1.06	MMS-32H	1.6	MC-12a,12b			1	50
0.55	1.6	1.5	1.4	MMS-32H	1.6	MC-12a,12b			1	50
0.75	2.0	1.9	1.8	MMS-32H	2.5	MC-12a,12b			1	50
1.1	2.8	2.7	2.6	MMS-32H	4	MC-22b			1	50
1.5	3.8	3.6	3.5	MMS-32H	4	MC-22b			1	50
2.2	5.2	4.9	4.7	MMS-32H	6	MC-22b			1	50
3.0	6.8	6.5	6.3	MMS-32H	8	MC-40a			1	50
4.0	8.9	8.5	8.2	MMS-32H	10	MC-40a			1	50
5.5	12.1	11.5	11.1	MMS-32H	13	MC-40a			3	50
7.5	16.3	15.5	14.9	MMS-32H	17	MC-40a			3	50
11.0	23.2	22.0	21.2	TD100	25	MC-50a	MT-63	18-25	3	70
15.0	31	29	28	TD100	32	MC-50a	MT-63	24-36	3	70
18.5	37	35	34	TD100	40	MC-50a	MT-63	28-40	3	70
22	43	41	40	TD100	50	MC-50a	MT-63	34-50	3	70
30	58	55	53	TD100	63	MC-65a	MT-63	45-65	3	70
37	69	66	64	TD100	80	MC-75a	MT-95	54-75	5	70
45	84	80	77	TD100	100	MC-85a	MT-95	63-85	5	70
55	-	-	93	TD100	100	MC-100a	MT-95	70-95	5	70

Type 2 Coordination (380/415V)

415V

Susol MCCB

kW	Rated Operational Power			Circuit Breaker		Contactor	Thermal Overload Relays		Short Circuit Breaking Capacity	
	Current [A]			Type	Rating [A]	Type	Type	Setting Range [A]	Ir [kA]	Iq [kA]
	380V	400V	415V							
0.06	0.21	0.20	0.19	TS100 (1)	1.6	MC-6a	MT-12	0.16~0.25	1	50
0.09	0.32	0.30	0.29	TS100 (1)	1.6	MC-6a	MT-12	0.25~0.4	1	50
0.12	0.46	0.44	0.42	TS100 (1)	1.6	MC-6a	MT-12	0.4~0.63	1	50
0.18	0.63	0.60	0.58	TS100 (1)	1.6	MC-6a	MT-12	0.4~0.63	1	50
0.25	0.89	0.85	0.82	TS100 (1)	1.6	MC-6a	MT-12	0.63~1	1	50
0.37	1.16	1.10	1.06	TS100 (1)	1.6	MC-12a,12b	MT-12	1~1.6	1	50
0.55	1.6	1.5	1.4	TS100 (1)	1.6	MC-12a,12b	MT-12	1~1.6	1	50
0.75	2.0	1.9	1.8	TS100 (1)	1.6	MC-12a,12b	MT-12	1.6~2.5	1	50
1.1	2.8	2.7	2.6	TS100 (1)	3.2	MC-22b	MT-32	2.5~4	1	50
1.5	3.8	3.6	3.5	TS100 (1)	3.2	MC-22b	MT-32	2.5~4	1	50
2.2	5.2	4.9	4.7	TS100 (1)	3.2	MC-22b	MT-32	4~6	1	50
3.0	6.8	6.5	6.3	TS100 (1)	6.3	MC-40a	MT-32	5~8	1	50
4.0	8.9	8.5	8.2	TS100 (1)	6.3	MC-40a	MT-32	6~9	1	50
5.5	12.1	11.5	11.1	TS100 (1)	12	MC-40a	MT-32	9~13	3	50
7.5	16.3	15.5	14.9	TS100 (1)	12	MC-40a	MT-32	12~18	3	50
11.0	23.2	22.0	21.2	TD100	25	MC-50a	MT-63	18~25	3	70
15.0	31	29	28	TD100	32	MC-50a	MT-63	24~36	3	70
18.5	37	35	34	TD100	40	MC-50a	MT-63	28~40	3	70
22	43	41	40	TD100	50	MC-50a	MT-63	34~50	3	70
30	58	55	53	TD100	63	MC-65a	MT-63	45~65	3	70
37	69	66	64	TD100	80	MC-75a	MT-95	54~75	5	70
45	84	80	77	TD100	100	MC-85a	MT-95	63~85	5	70
55	-	-	93	TD100	100	MC-100a	MT-95	70~95	5	70

Note) (1) This marks admit for motor protection MTU trip unit only.

Rated short circuit breaking capacity of installation

Manual Motor Starter	Adjustment Range (A)	Manual Motor Controller Group Installation			Applied Contactor (Susol MC)	Applied Contactor (Metasol MC)	Applied Contactor (Meta-MEC GMC)
		Short Circuit Rating(KAIC)					
		240V	480Y/277V	600Y/347V			
32AF Rotary operation, standard interruption							
MMS-32H-0.16	0.1~0.16	100	65	25	MC-9	MC-6a/MC-9a/MC-9b	GMC-6M/GMC-9
MMS-32H-0.25	0.16~0.25	100	65	25	MC-9	MC-6a/MC-9a/MC-9b	GMC-6M/GMC-9
MMS-32H-0.4	0.25~0.4	100	65	25	MC-9	MC-6a/MC-9a/MC-9b	GMC-6M/GMC-9
MMS-32H-0.63	0.4~0.63	100	65	25	MC-9	MC-6a/MC-9a/MC-9b	GMC-6M/GMC-9
MMS-32H-1	0.63~1	100	65	25	MC-9	MC-6a/MC-9a/MC-9b	GMC-6M/GMC-9
MMS-32H-1.6	1~1.6	100	65	25	MC-9	MC-6a/MC-9a/MC-9b	GMC-9M/GMC-9
MMS-32H-2.5	1.6~2.5	100	65	25	MC-12	MC-12a/MC-12b	GMC-12M/GMC-12
MMS-32H-4	2.5~4	100	65	25	MC-12	MC-12a/MC-12b	GMC-12M/GMC-12
MMS-32H-6	4~6	100	65	25	MC-18	MC-18a/MC-18b	GMC-18
MMS-32H-8	5~8	100	65	10	MC-18	MC-18a/MC-18b	GMC-18
MMS-32H-10	6~10	100	65	10	MC-18	MC-18a/MC-18b	GMC-18
MMS-32H-13	9~13	100	65	10	MC-25	MC-22b/MC-25a	GMC-22
MMS-32H-17	11~17	100	30	10	MC-25	MC-22b/MC-25a	GMC-22
MMS-32H-22	14~22	100	30	10	MC-25	MC-22b/MC-25a	GMC-32
MMS-32H-26	18~26	100	30	10	MC-32	MC-32a	GMC-32
MMS-32H-32	22~32	100	30	10	MC-32	MC-32a	GMC-32
MMS-32H-40	28~40	100	30	10	-	MC-35a/MC-40a	-
63AF Rotary operation, standard interruption							
MMS-63S-10	6~10	100	50	10	MC-35	MC-50a	GMC-32
MMS-63S-13	9~13	100	50	10	MC-35	MC-50a	GMC-32
MMS-63S-17	11~17	100	40	10	MC-35	MC-50a	GMC-32
MMS-63S-22	14~22	100	40	10	MC-35	MC-50a	GMC-32
MMS-63S-26	18~26	100	40	10	MC-35	MC-50a	GMC-32
MMS-63S-32	22~32	100	40	10	MC-35	MC-50a	GMC-32
MMS-63S-40	28~40	100	40	10	MC-40	MC-50a	GMC-40
MMS-63S-50	34~50	100	40	10	MC-50	MC-50a	GMC-50
MMS-63S-63	45~63	100	40	10	MC-63	MC-65a	GMC-65
MMS-63S-65	47~65	100	40	10	-	MC-65a	-
63AF Rotary operation, High interruption							
MMS-63H-10	6~10	100	65	25	MC-35	MC-50a	GMC-32
MMS-63H-13	9~13	100	65	25	MC-35	MC-50a	GMC-32
MMS-63H-17	11~17	100	50	10	MC-35	MC-50a	GMC-32
MMS-63H-22	14~22	100	50	10	MC-35	MC-50a	GMC-32
MMS-63H-26	18~26	100	50	10	MC-35	MC-50a	GMC-32
MMS-63H-32	22~32	100	50	10	MC-35	MC-50a	GMC-32
MMS-63H-40	28~40	100	50	10	MC-40	MC-50a	GMC-40
MMS-63H-50	34~50	100	50	10	MC-50	MC-50a	GMC-50
MMS-63H-63	45~63	100	50	10	MC-63	MC-65a	GMC-65
MMS-63H-65	47~65	100	40	10	-	MC-65a	-
100AF Rotary operation, Standard interruption							
MMS-100S-17	11~17	100	50	10	MC-65	MC-75a	GMC-50
MMS-100S-22	14~22	100	50	10	MC-65	MC-75a	GMC-50
MMS-100S-26	18~26	100	50	10	MC-65	MC-75a	GMC-50
MMS-100S-32	22~32	100	50	10	MC-65	MC-75a	GMC-50
MMS-100S-40	28~40	100	50	10	MC-65	MC-75a	GMC-50
MMS-100S-50	34~50	100	50	10	MC-65	MC-75a	GMC-50
MMS-100S-63	45~63	100	40	10	MC-65	MC-75a	GMC-65
MMS-100S-75	55~75	100	40	10	MC-75	MC-75a	GMC-75
MMS-100S-90	70~90	100	40	10	MC-85	MC-85a	GMC-85
MMS-100S-100	80~100	100	40	10	MC-95	MC-100a	GMC-85
100AF Rotary operation, High interruption							
MMS-100H-17	11~17	100	65	25	MC-65	MC-75a	GMC-50
MMS-100H-22	14~22	100	65	20	MC-65	MC-75a	GMC-50
MMS-100H-26	18~26	100	65	20	MC-65	MC-75a	GMC-50
MMS-100H-32	22~32	100	65	20	MC-65	MC-75a	GMC-50
MMS-100H-40	28~40	100	65	20	MC-65	MC-75a	GMC-50
MMS-100H-50	34~50	100	65	20	MC-65	MC-75a	GMC-50
MMS-100H-63	45~63	100	50	10	MC-65	MC-75a	GMC-65
MMS-100H-75	55~75	100	50	10	MC-75	MC-75a	GMC-75
MMS-100H-90	70~90	100	50	10	MC-85	MC-85a	GMC-85
MMS-100H-100	80~100	100	50	10	MC-95	MC-100a	GMC-85

Contactors (18AF/22AF)

MC-6a-18a AC

1a or 1b

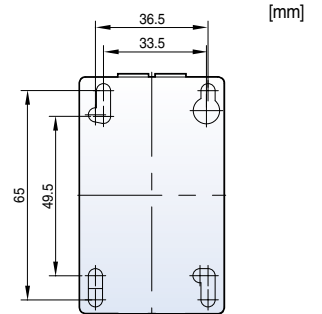
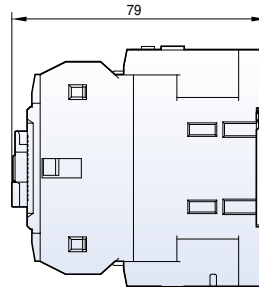
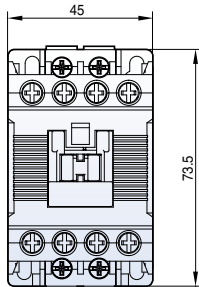

[mm]

0.3kg

MC-6a-18a DC

1a or 1b

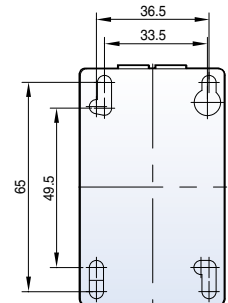
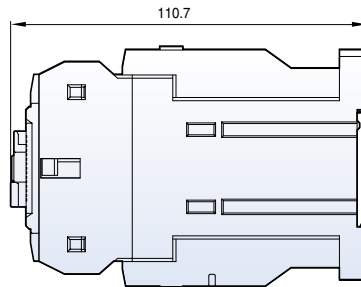
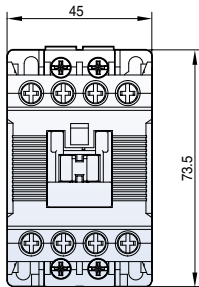

0.5kg

MC-9b-22b AC

1a1b

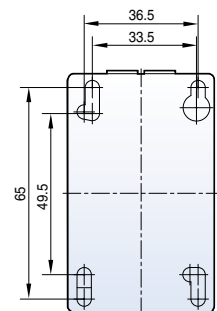
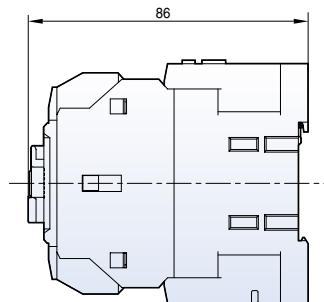
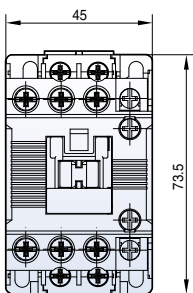

0.3kg

MC-9b-22b DC

1a1b

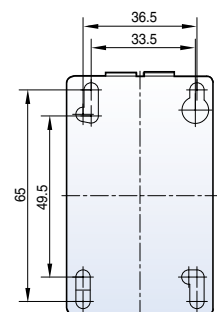
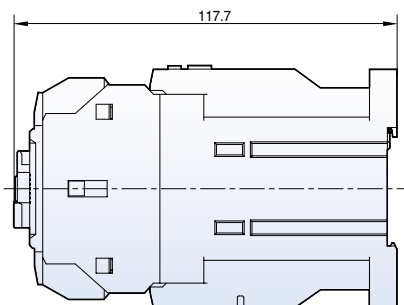
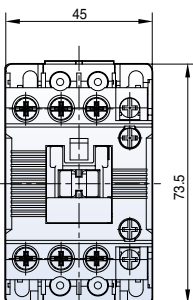

0.5kg

Contactors (40AF)

MC-32a-40a AC

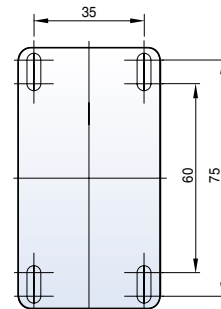
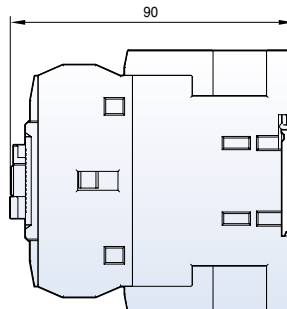
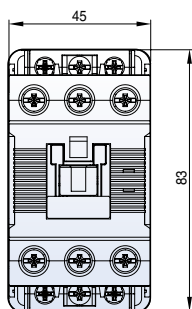

[mm]

0.4kg

MC-32a-40a DC

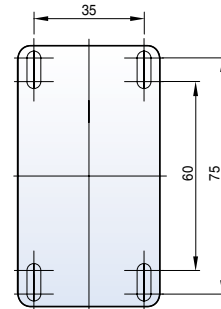
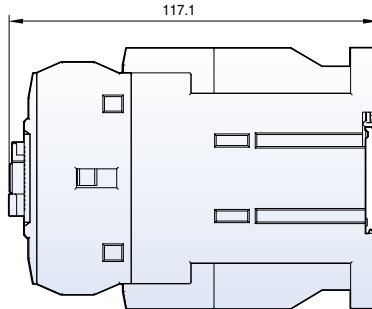
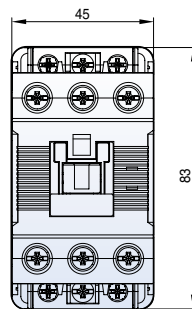

0.6kg

MC-32a-40a AC

2a2b

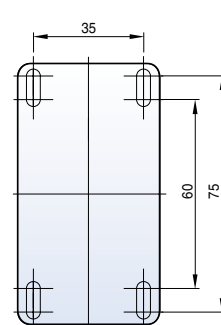
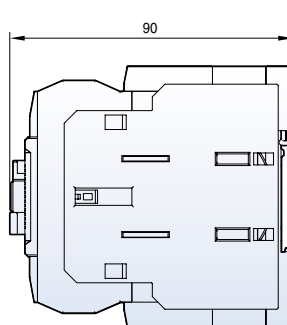
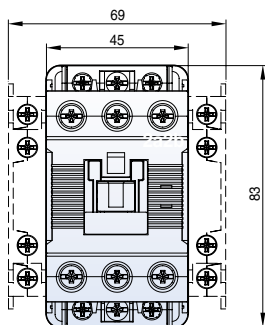

0.5kg

MC-32a-40a DC

2a2b

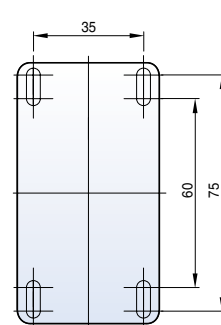
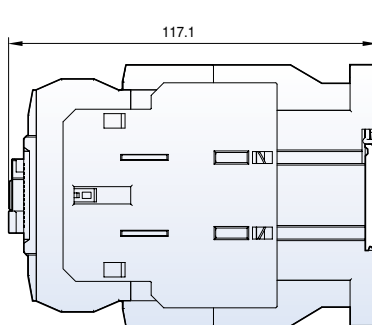
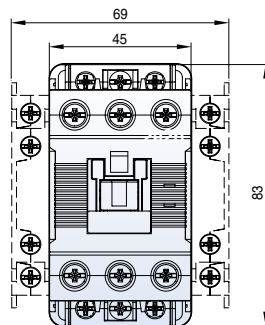

0.8kg

Contactors (65AF)

MC-50a-65a AC

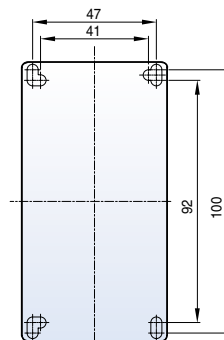
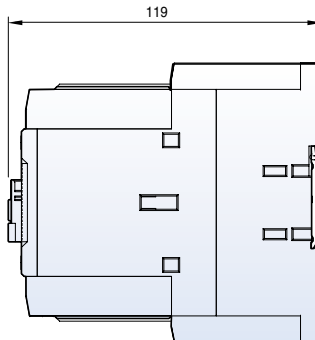
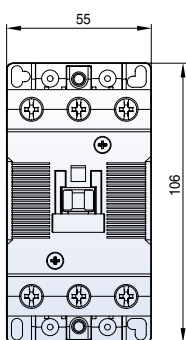

[mm]

0.9kg

MC-50a-65a DC

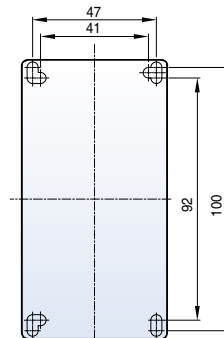
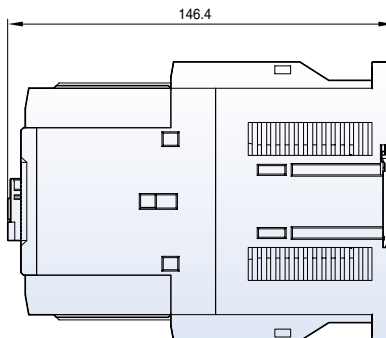
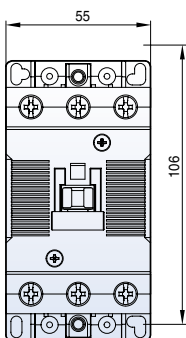

1.2kg

MC-50a-65a AC

2a2b

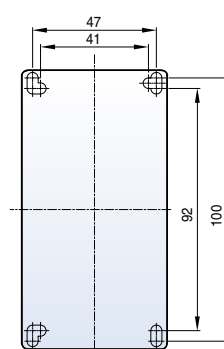
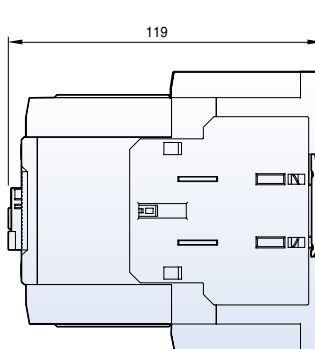
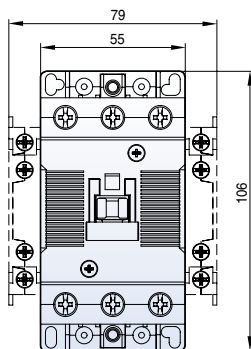

1kg

MC-50a-65a DC

2a2b

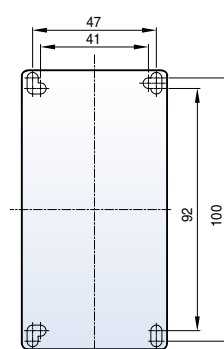
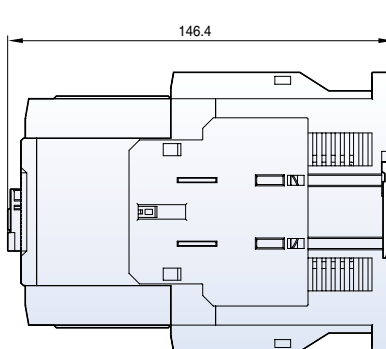
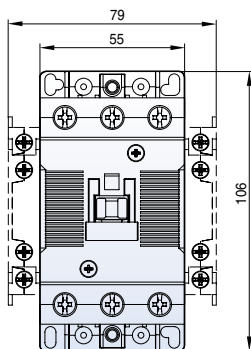

1.3kg

Contactors (100AF)

MC-75a~100a AC

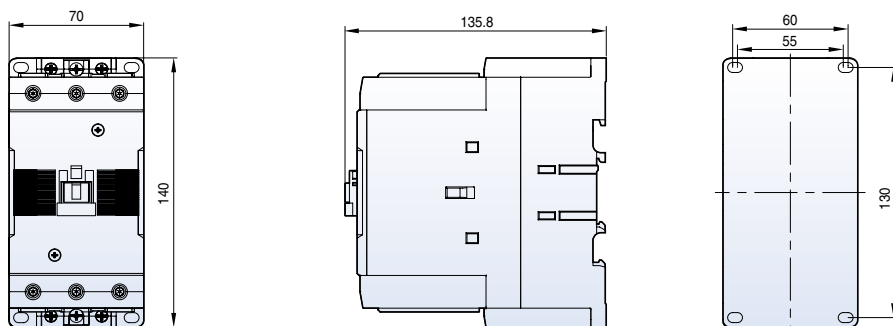

[mm]

1.8kg

MC-75a~100a DC

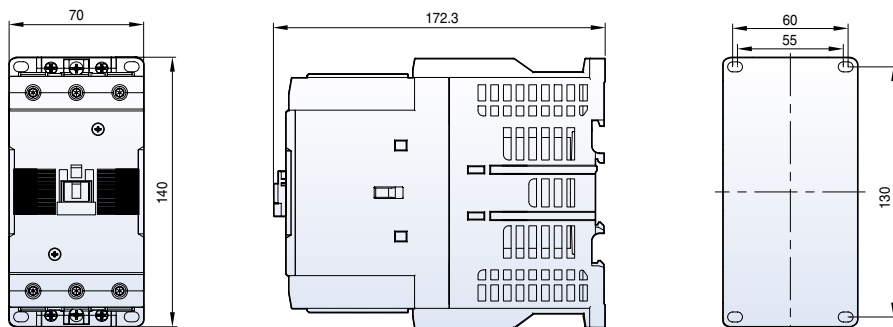

2.7kg

MC-75a~100a AC

2a2b

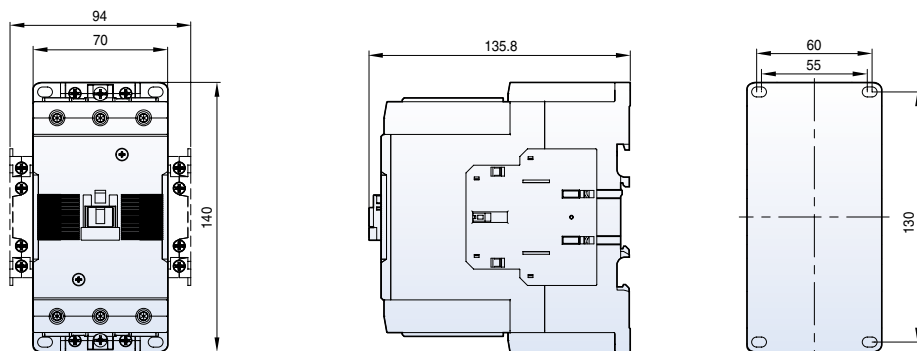

1.9kg

MC-75a~100a DC

2a2b

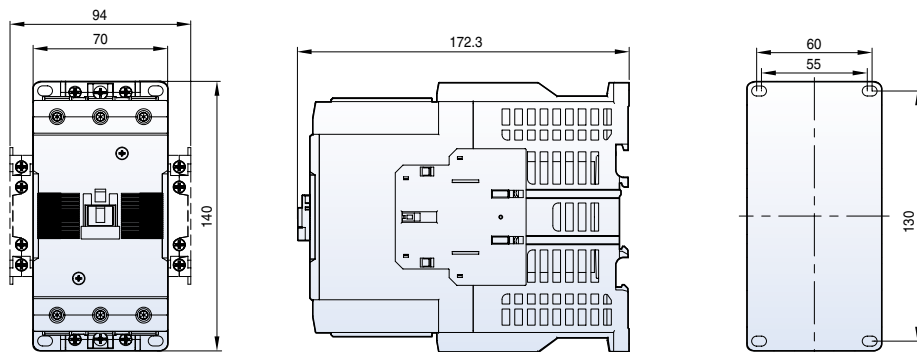

2.8kg

Contactors (150AF~800AF)

MC-130a

MC-150a

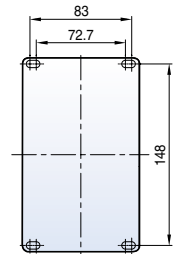
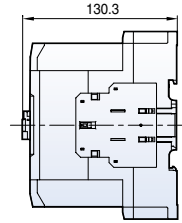
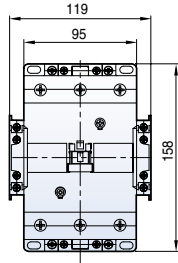

[mm]

2.4kg

MC-185a

MC-225a

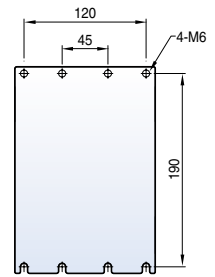
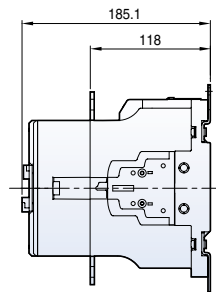
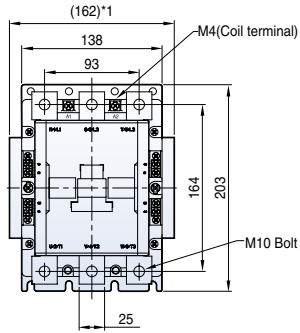

5.4kg

MC-265a

MC-330a

MC-400a

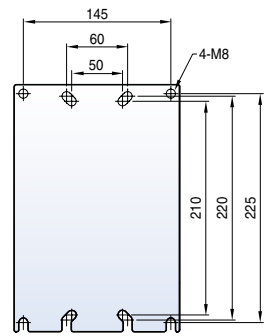
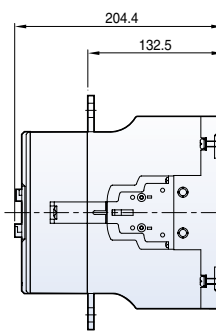
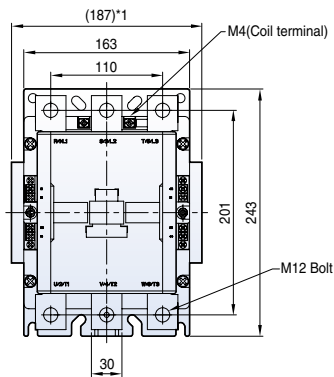

9.2kg

MC-500a

MC-630a

MC-800a

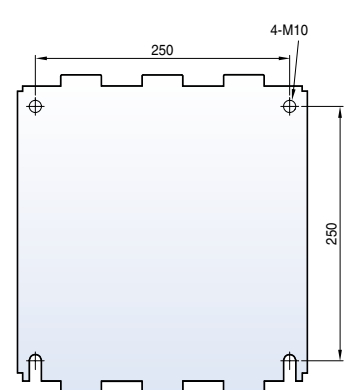
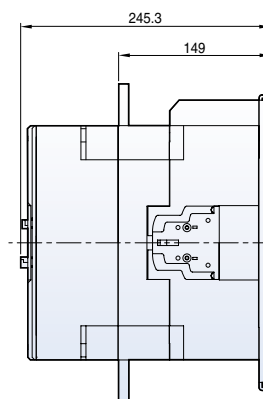
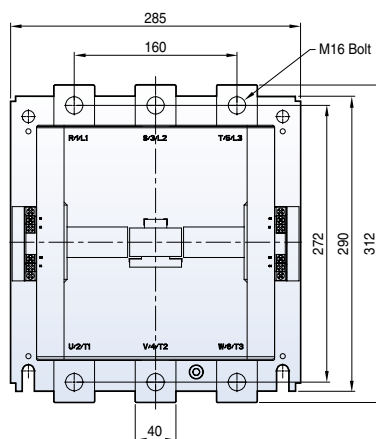

22.4kg

Motor starters (18AF~40AF)

MS-6a~18a

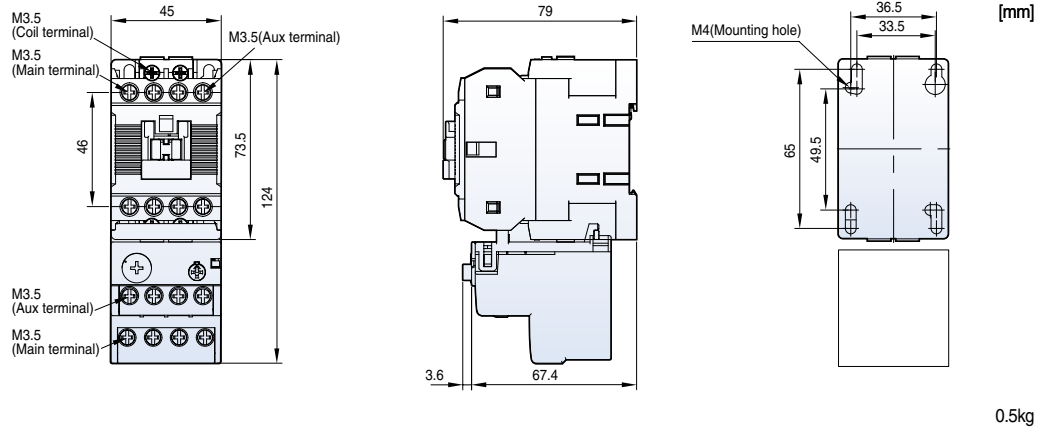

[mm]

0.5kg

MS-9b~22b

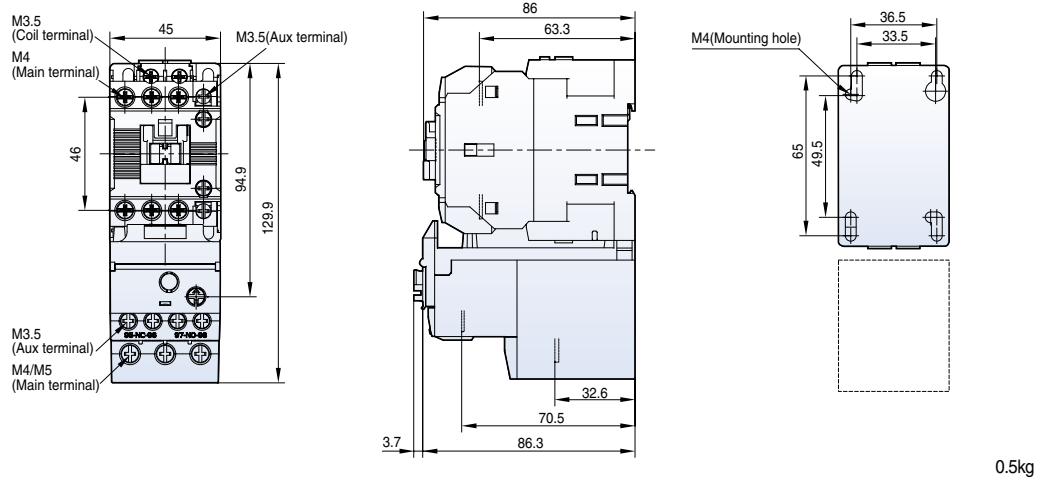

0.5kg

MS-32a~40a

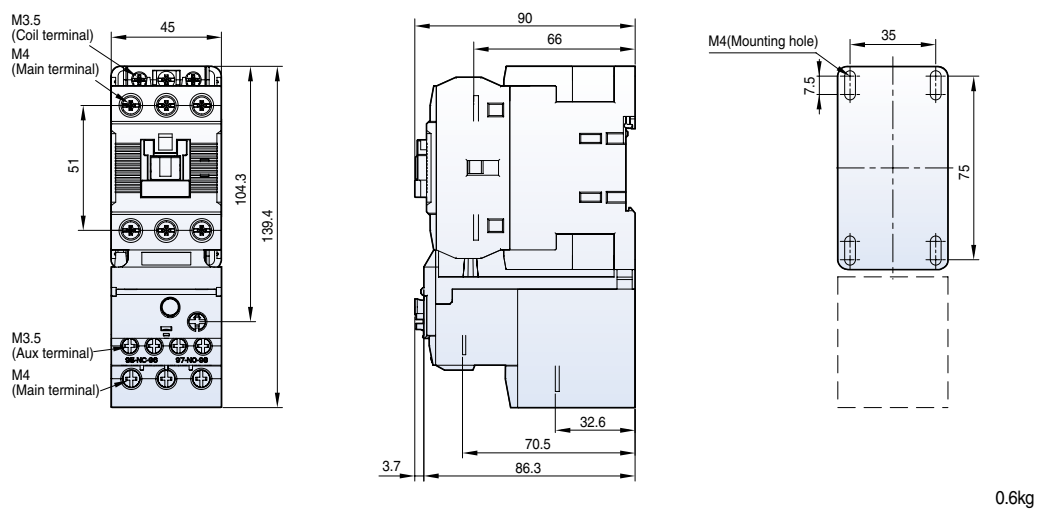

0.6kg

Motor starters (65AF~150AF)

MS-50a~65a

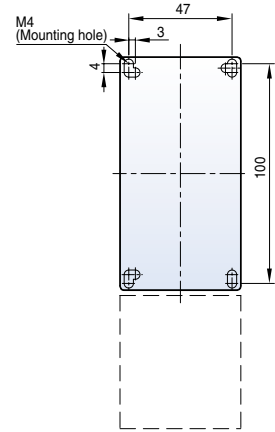
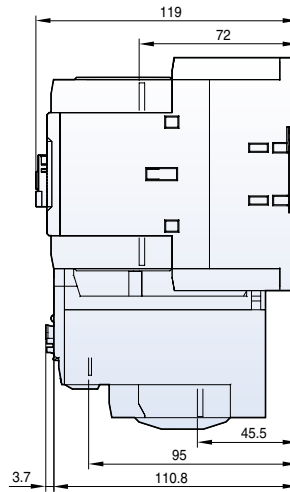
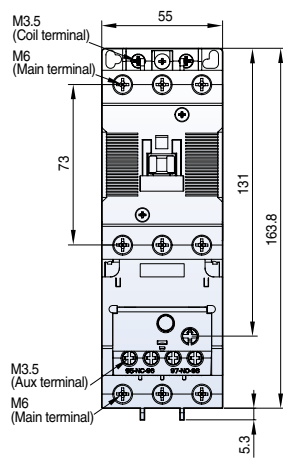

[mm]

1.3kg

MS-75a~100a

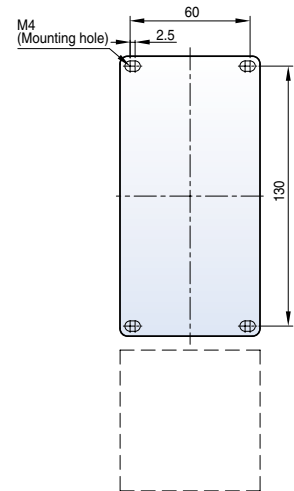
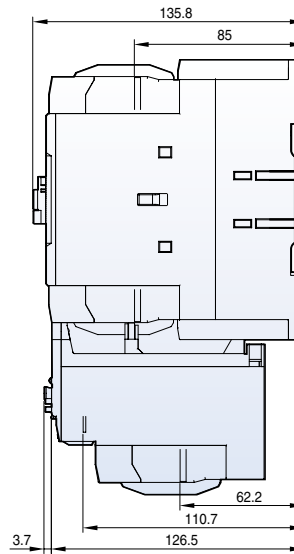
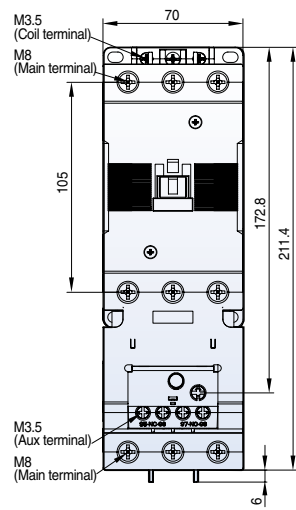

2.3kg

MS-130a

MS-150a

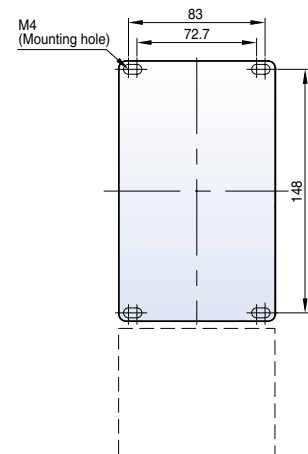
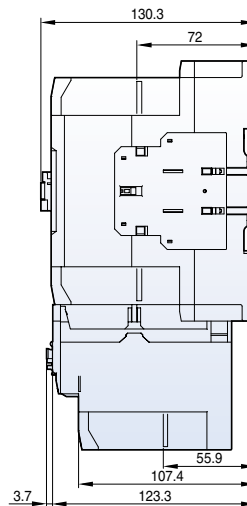
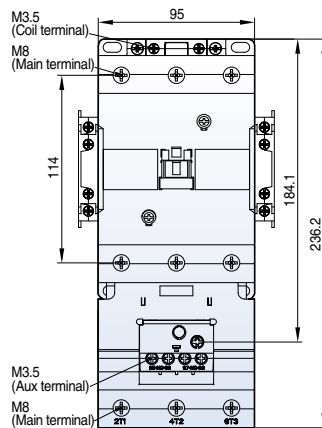

2.9kg

Motor starters (185AF~800AF)

- MS-185a
- MS-225a

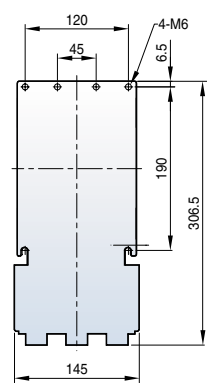
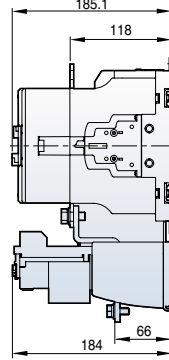
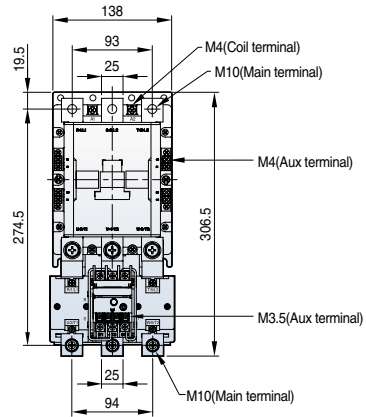

[mm]

7.9kg

- MS-265a
- MS-330a
- MS-400a

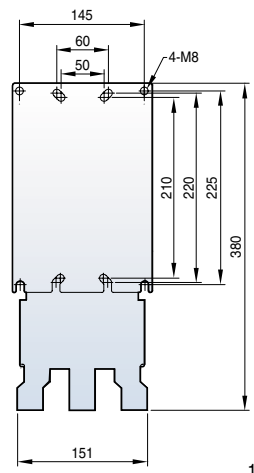
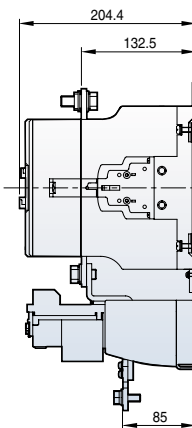
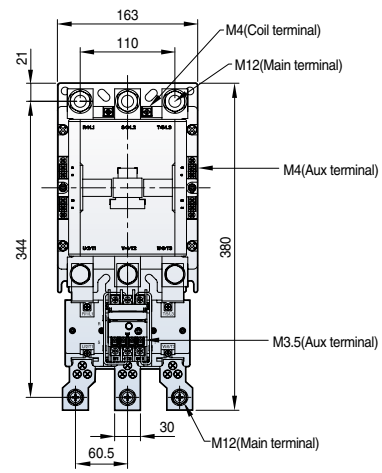

11.8kg

- MS-500a
- MS-630a
- MS-800a

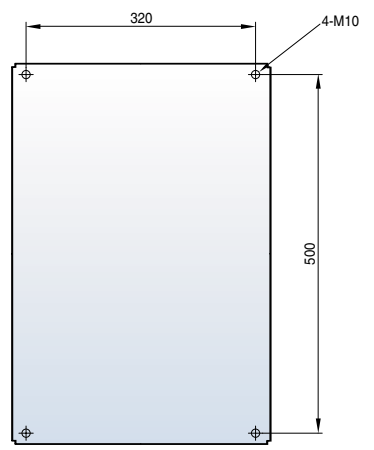
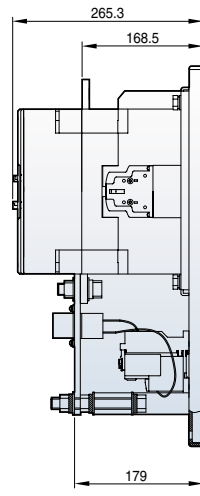
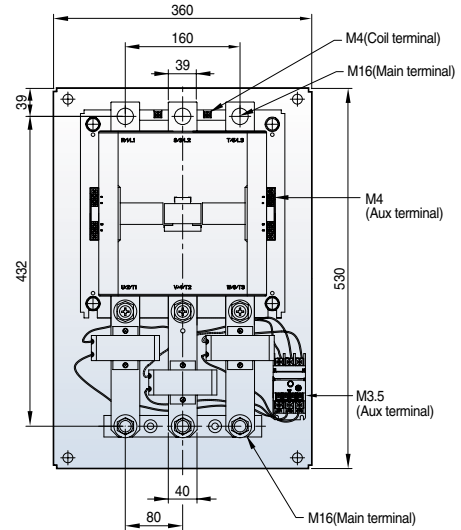

28kg

Reversing contactors and starters (18AF)

[mm]

MC-6aR-18aR AC

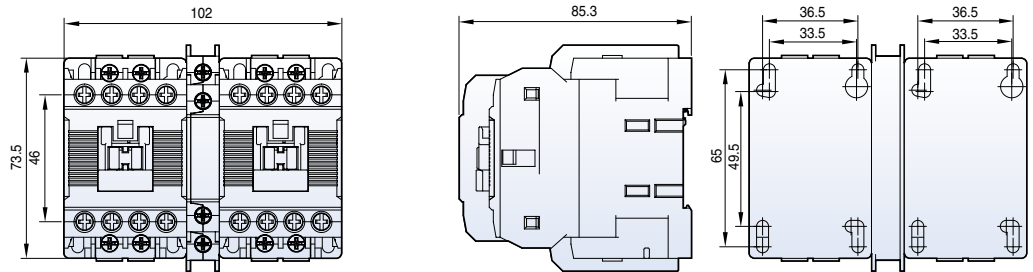

0.7kg

MC-6aR-18aR DC

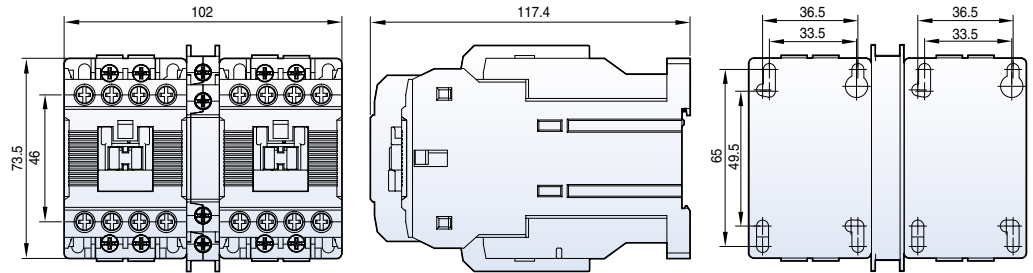

1kg

MS-6aR-18aR AC

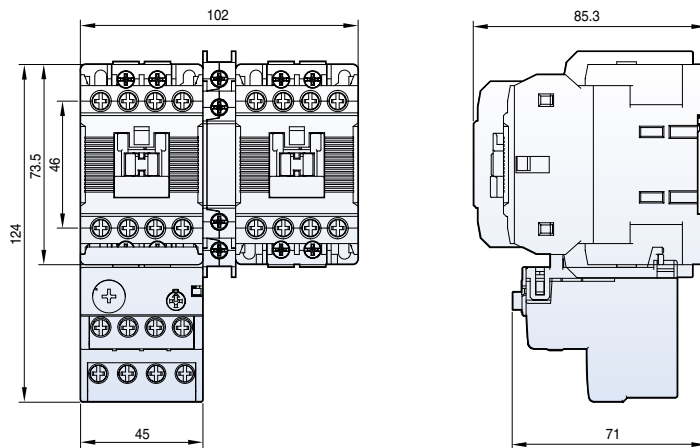

0.9kg

Reversing contactors and starters (22AF)

MC-9bR-22bR AC



0.7kg

MC-9bR-22bR DC

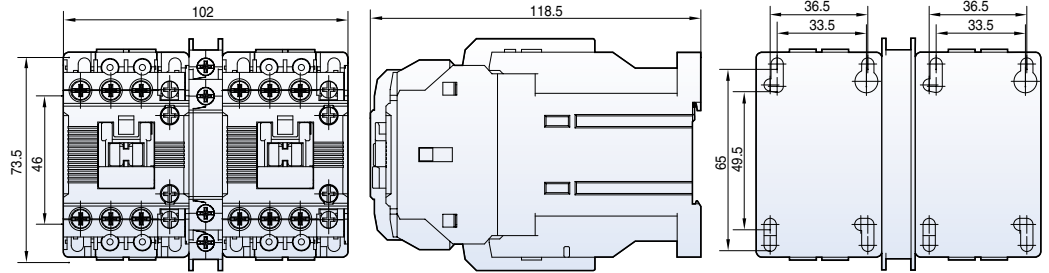

1.1kg

MS-9bR-22bR AC

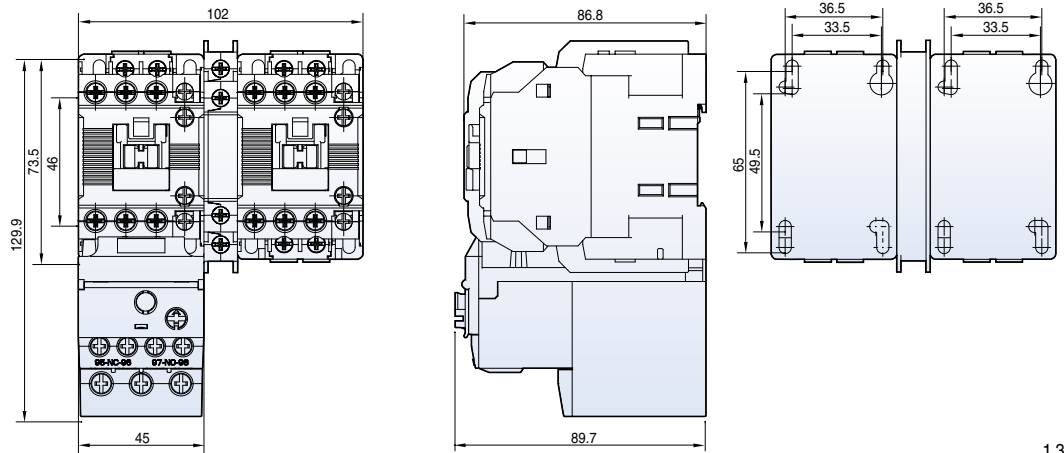

1.3kg

Reversing contactors and starters (40AF)

MC-32aR~40aR AC

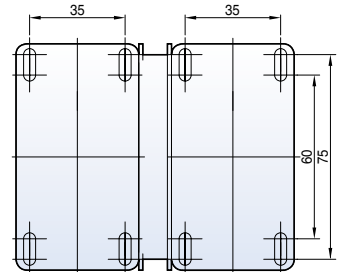
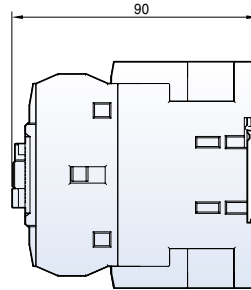
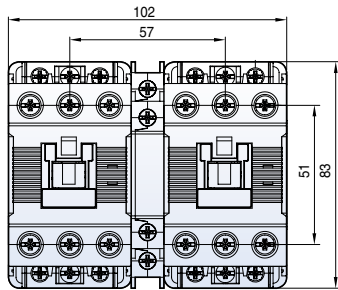

[mm]

0.9kg

MC-32aR~40aR DC

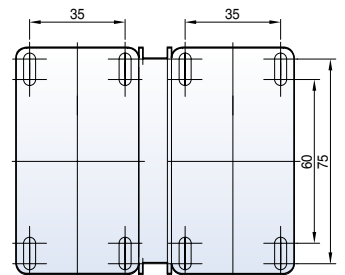
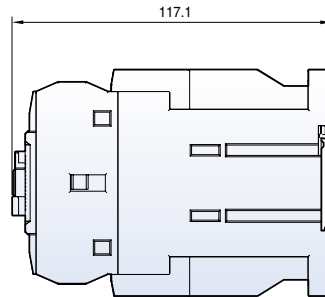
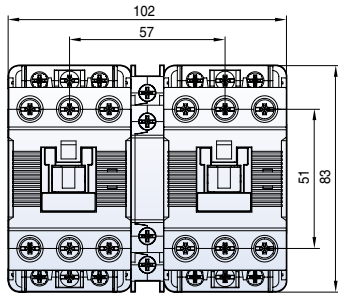

1.4kg

MS-32aR~40aR AC

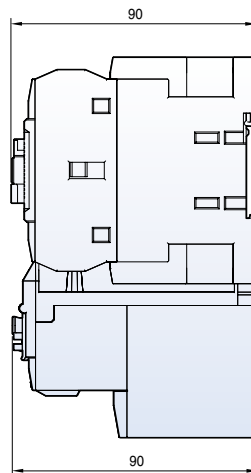
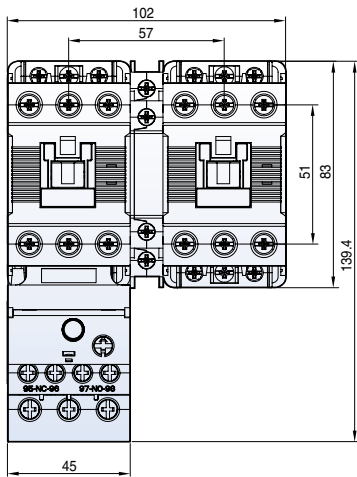

1.1kg

Reversing contactors and starters (65AF)

MC-50aR-65aR AC

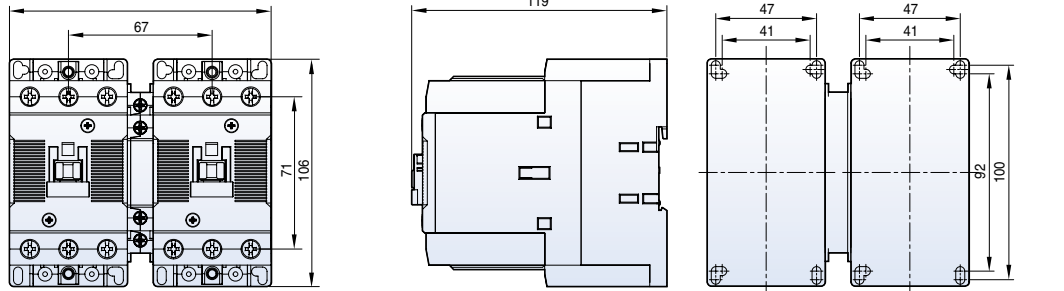

1.8kg

MC-50aR-65aR DC

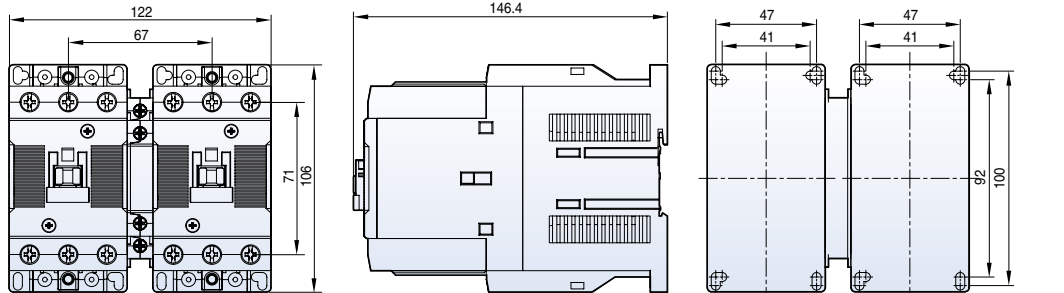

2.4kg

MS-50aR-65aR AC

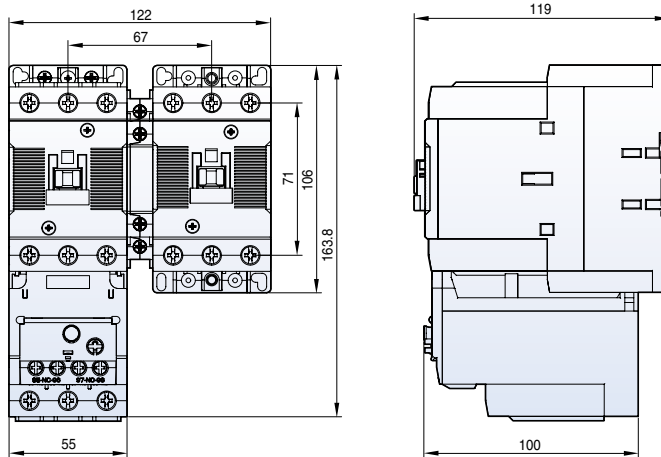

1.9kg

Reversing contactors and starters (100AF)

MC-75aR-100aR AC

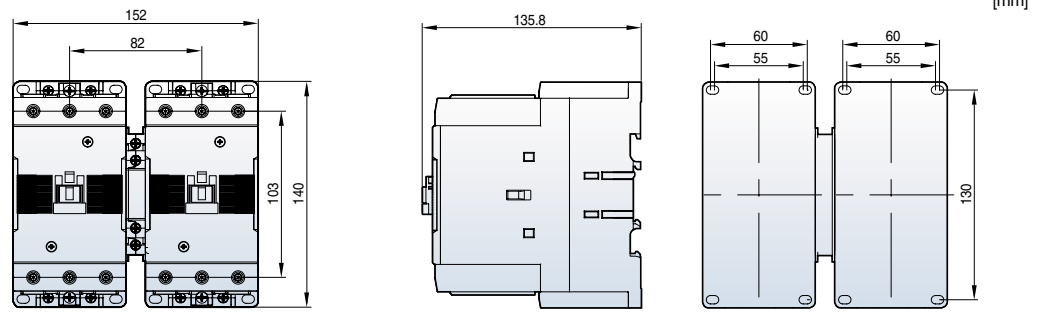

[mm]

3.3kg

MC-75aR-100aR DC

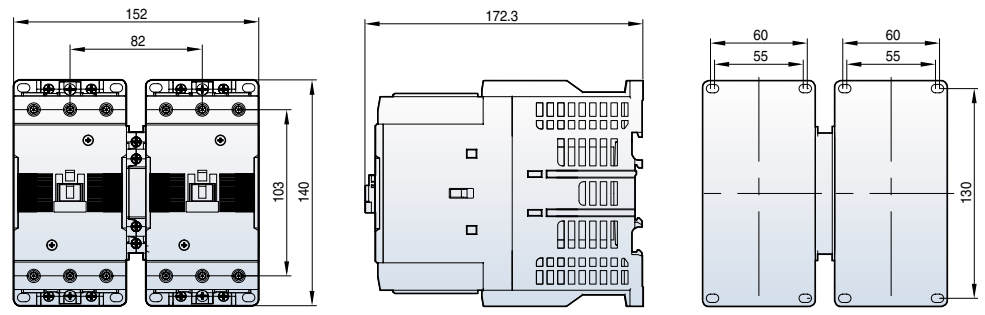

5.2kg

MS-75aR-100aR AC

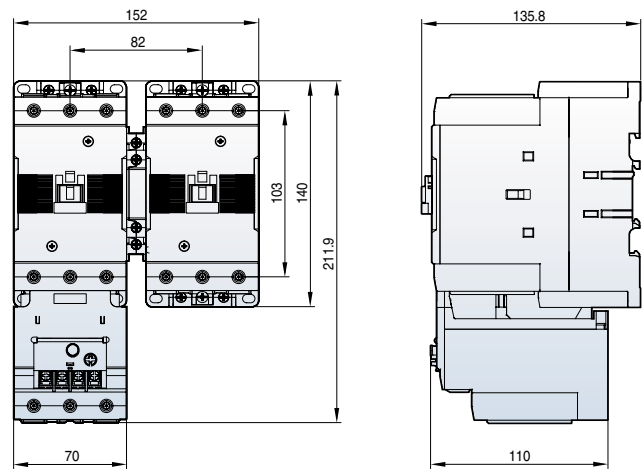

3.8kg

Reversing contactors and starters (150~800AF)

MC-130aR
MC-150aR

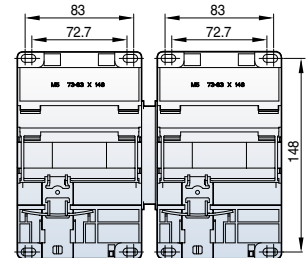
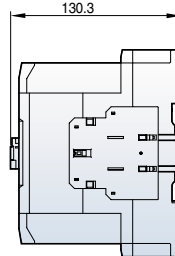
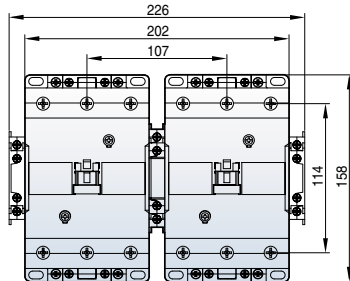

[mm]

4.3kg

MC-185aR
MC-225aR

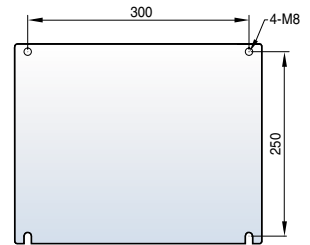
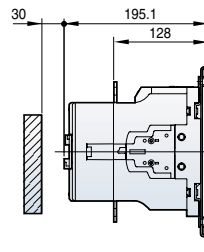
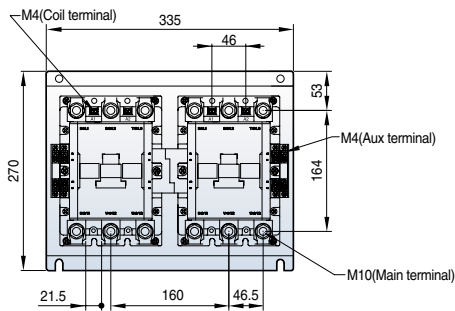

12.9kg

MC-265aR
MC-330aR
MC-400aR

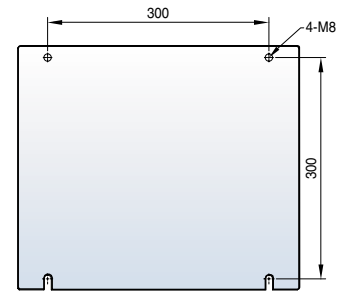
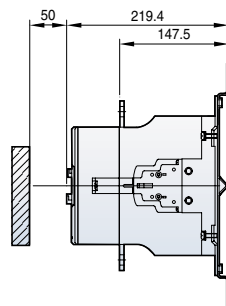
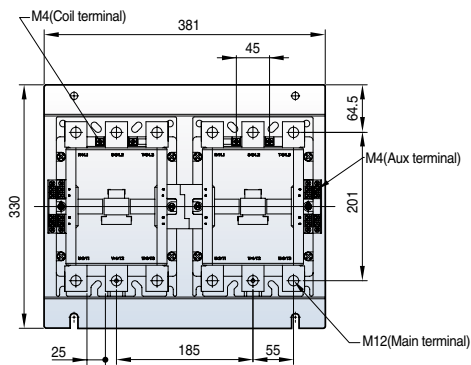

21.4kg

MC-500aR
MC-630aR
MC-800aR

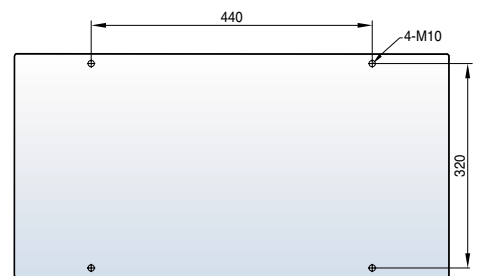
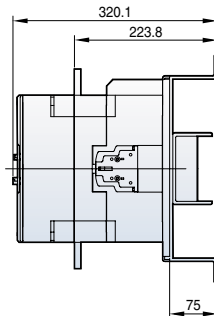
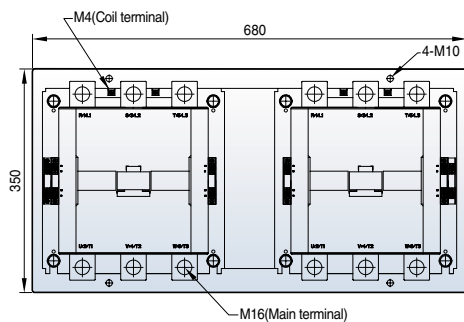

60kg

Reversing contactors and starters (150~400AF)

Metasol

[mm]

- MS-130aR AC
- MS-150aR AC

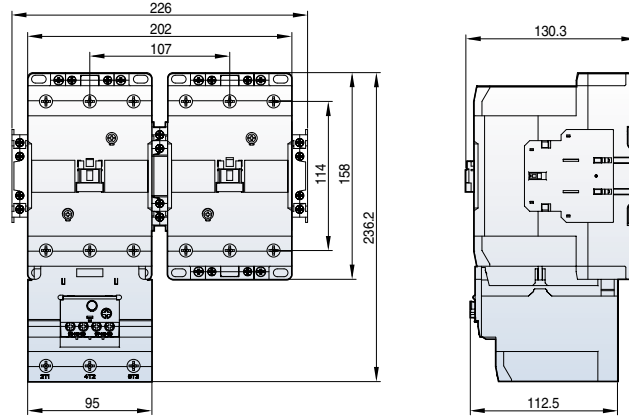

5kg

- MS-185aR AC
- MS-225aR AC

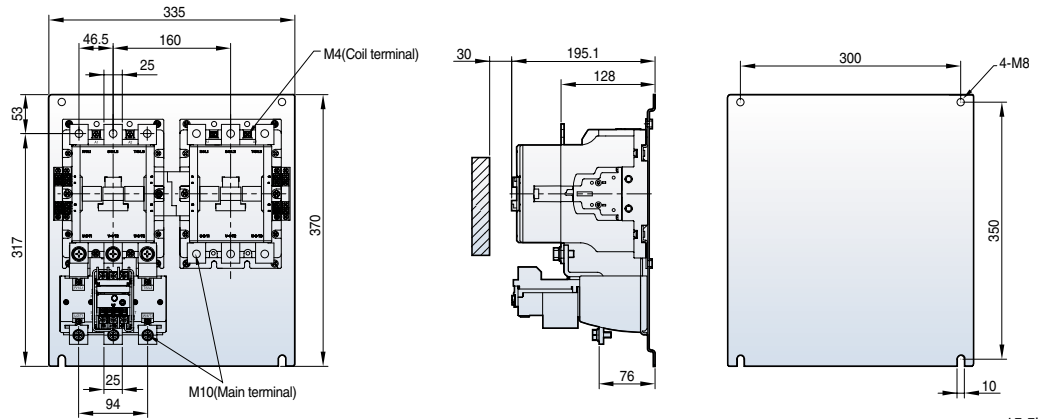

15.5kg

- MS-265aR DC
- MS-330aR DC
- MS-400aR DC

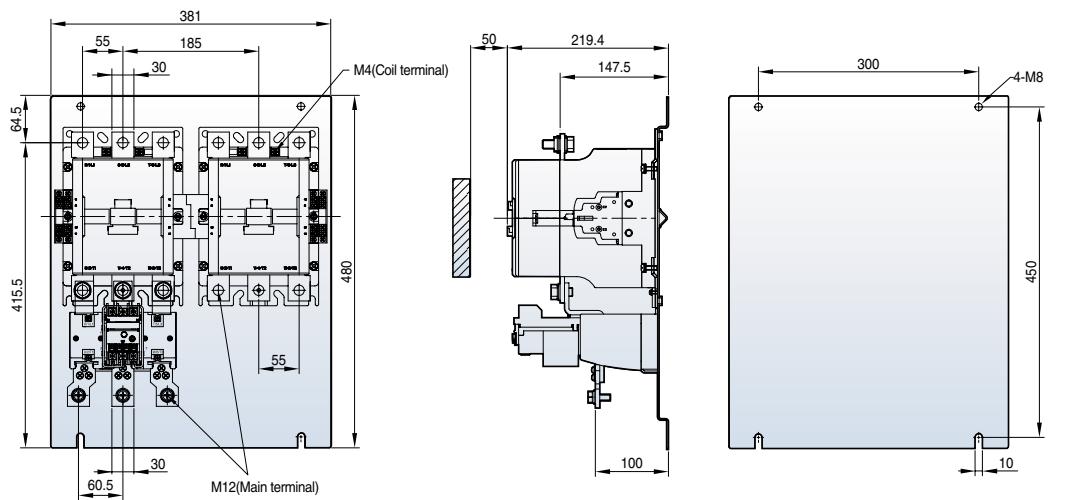

23kg

Overload relays

MT-12

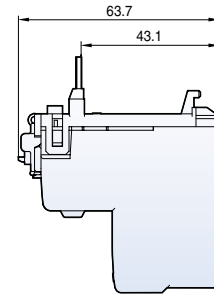
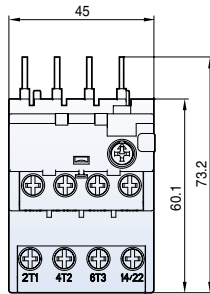

[mm]

100g

MT-32

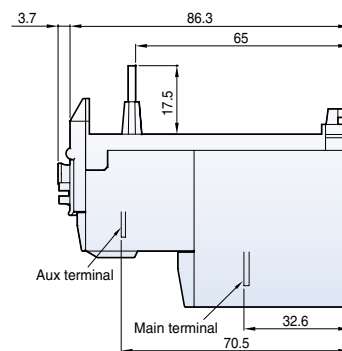
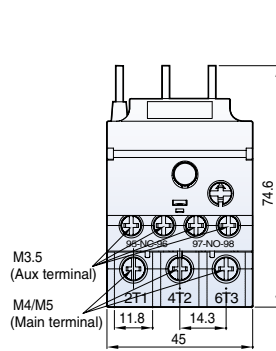

167g

MT-63

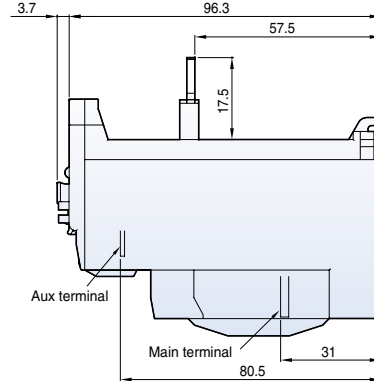
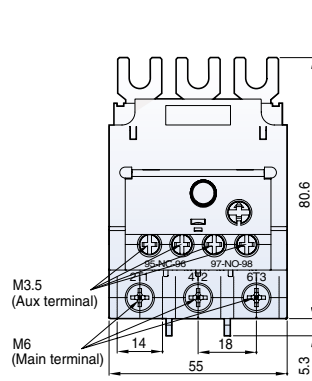

303g

MT-95

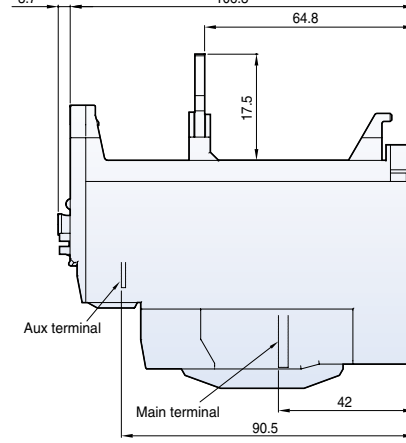
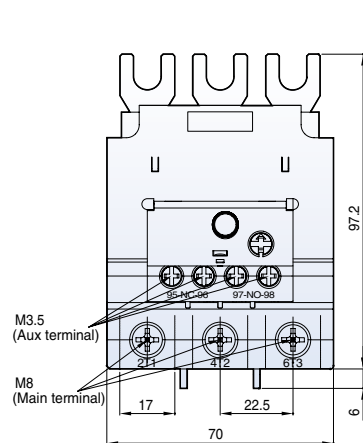

474g

Overload relays

Metasol

MT-150

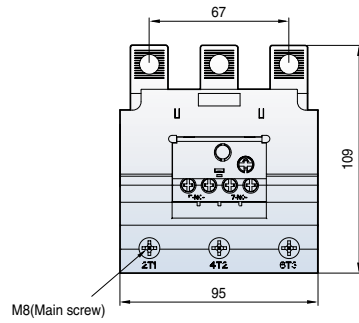

[mm]

0.7kg

MT-225

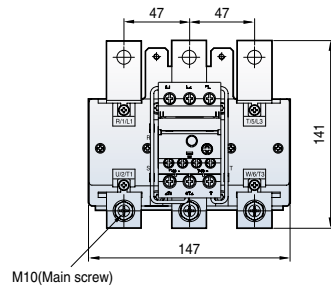

2.5kg

MT-400

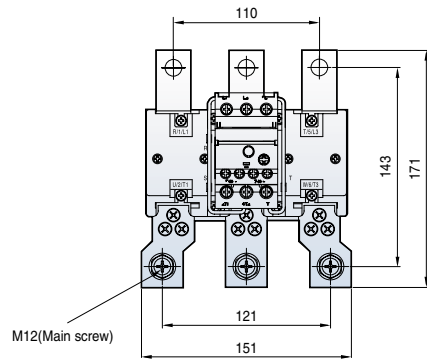

2.6kg

MT-800

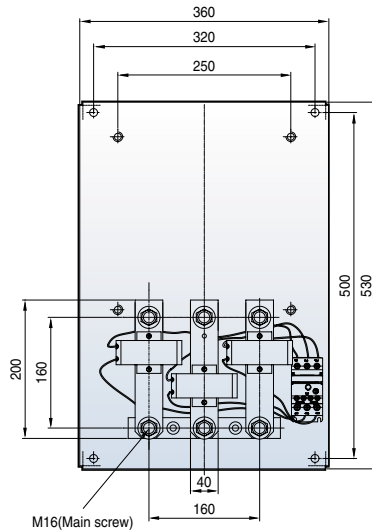

11.5kg

Overload relays (Separate mount)

UZ-32

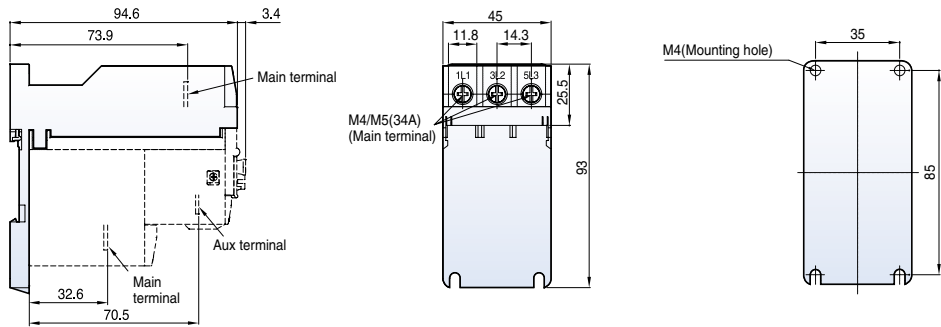

[mm]

68g

UZ-63

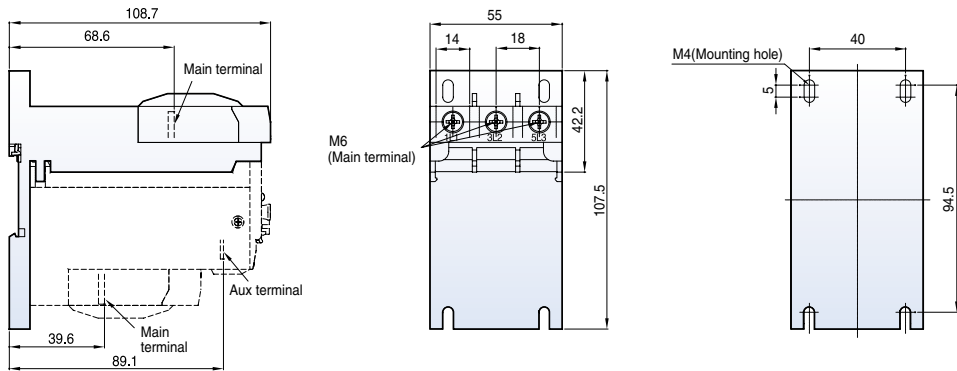

134g

UZ-95

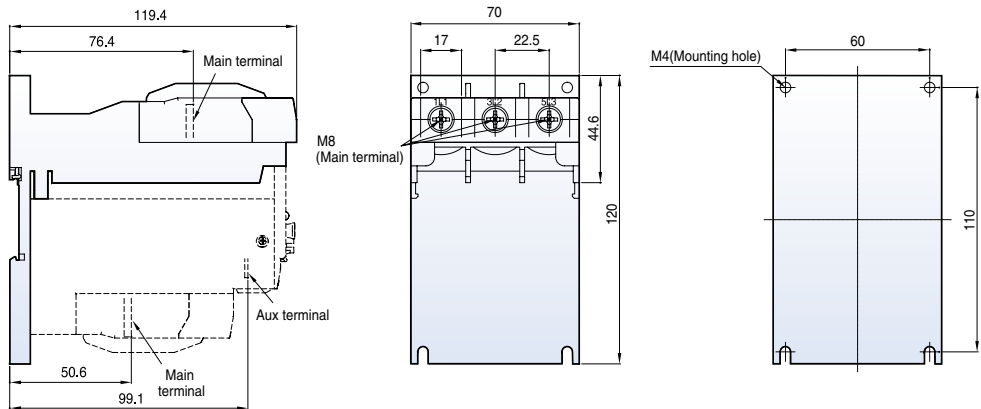

230g

UZ-150

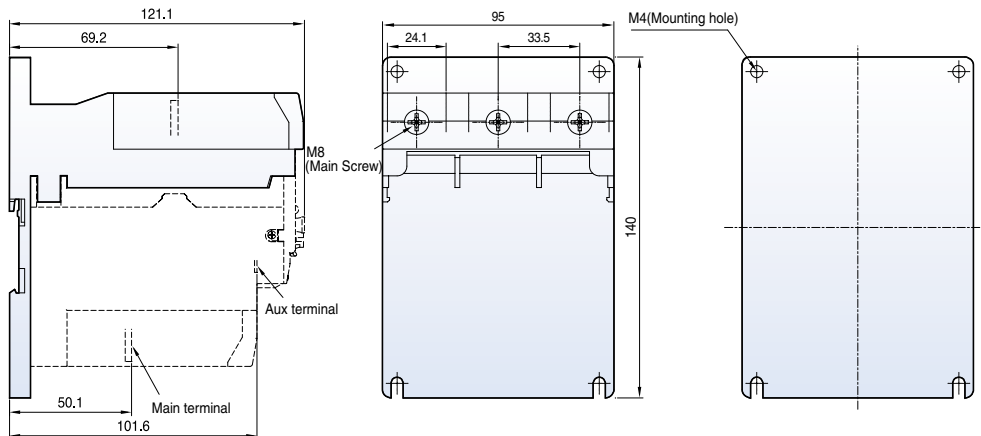

284g

Contact arrangement

Contactors

MC-6a~18a

1a

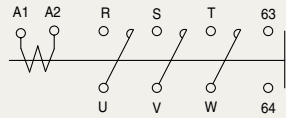

1b

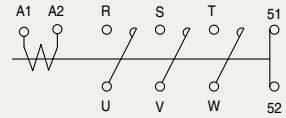

MC-9b~22b

1a1b

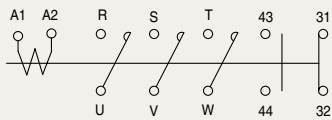

MC-32a~150a

2a2b

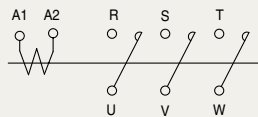
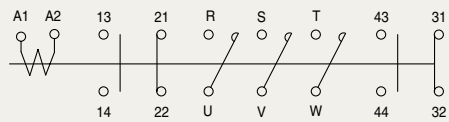

Motor starters

MS-6a~150a

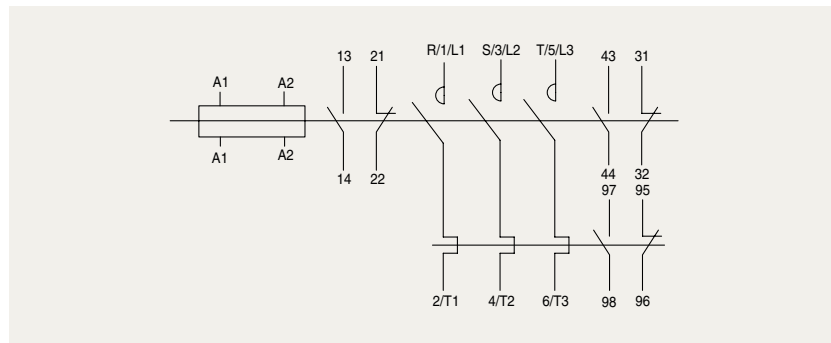
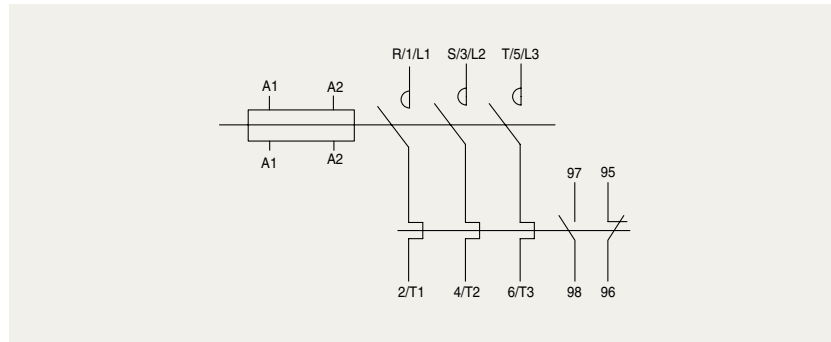

MS-185a~800a

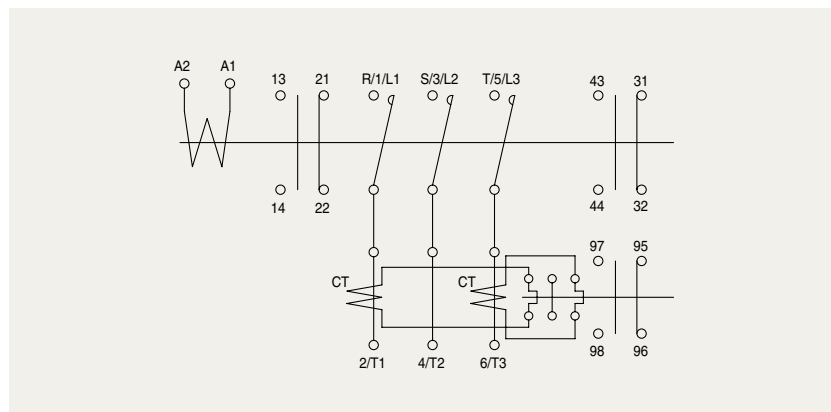

Reversing contactors

MC-6aR~150aR

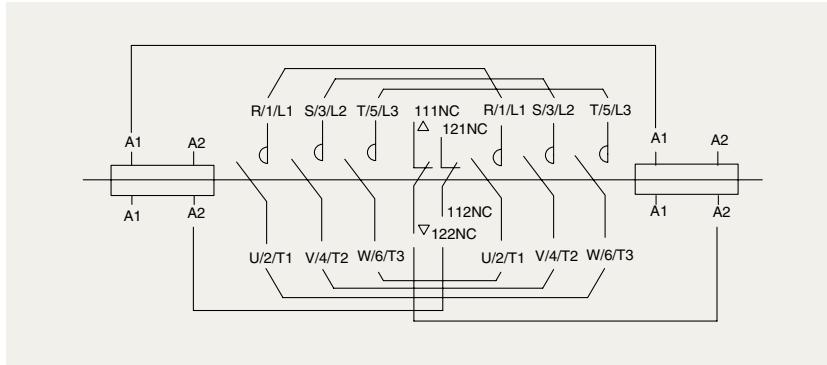

MS-6aR~150aR

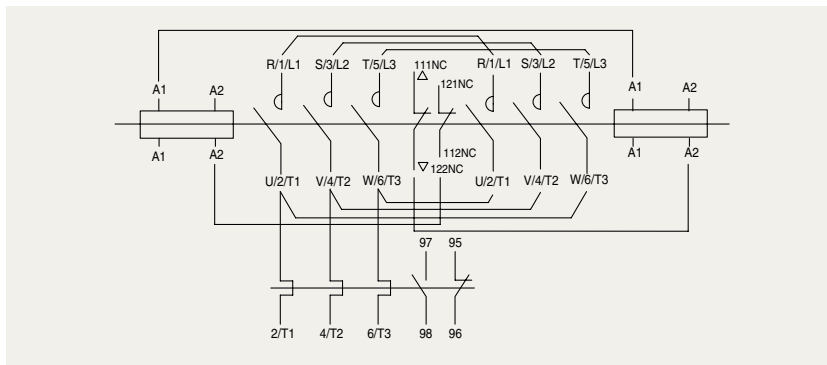

MC-185aR~800aR

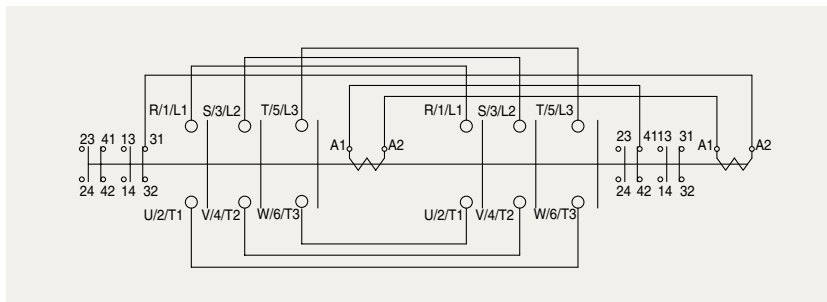

MS-185aR~400aR

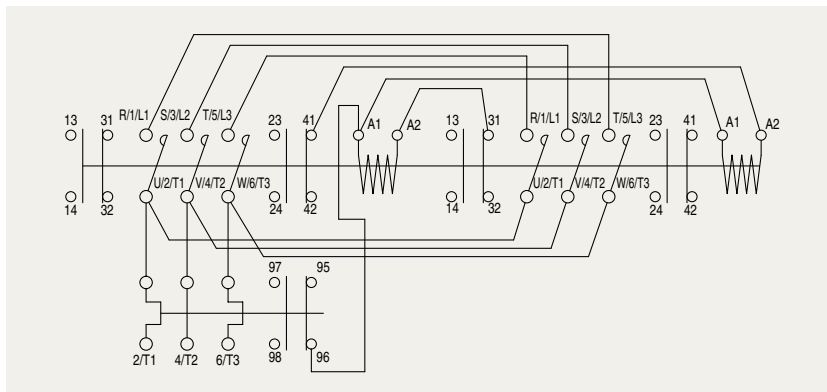



Mini Contactor



Contents :

Mini Contactor & Thermal Overload Relay

Catalog numbering system	108
Quick selection table	109
AC coil	110
DC coil	112
Motor starters, open	114
Mini contactors, Reversing type	115
Bimetallic style	119
2-pole DC Contactors	120
2-pole AC Contactors, Definite purpose	121
Accessories for mini contactors	122
Accessories	124
Dimensions	125



Catalog numbering system

Contactors & Starters

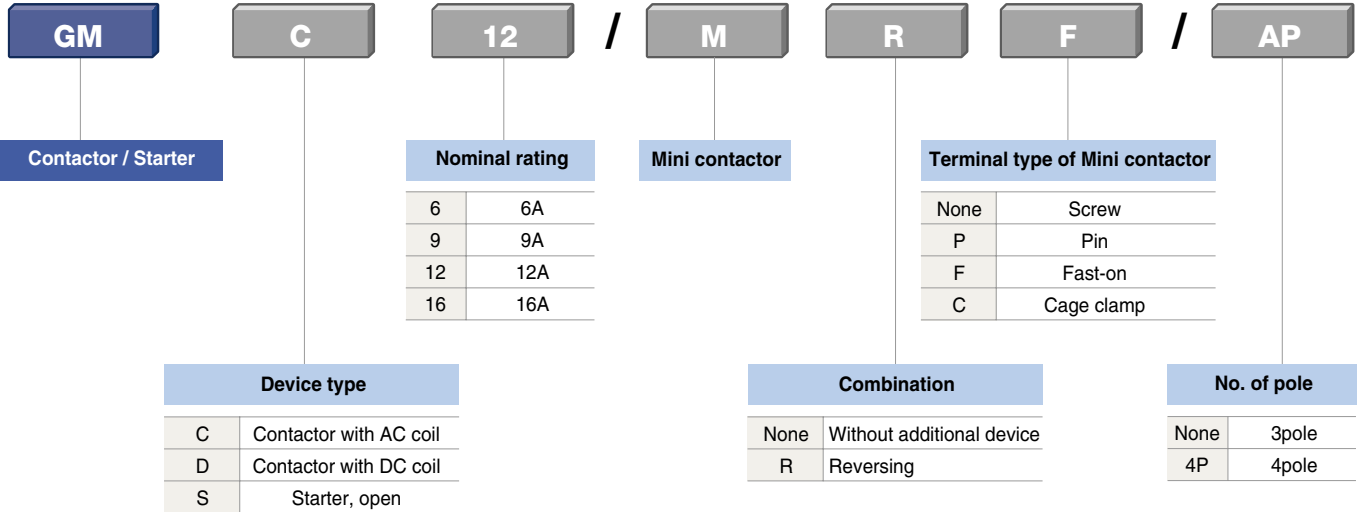

Thermal overload relay

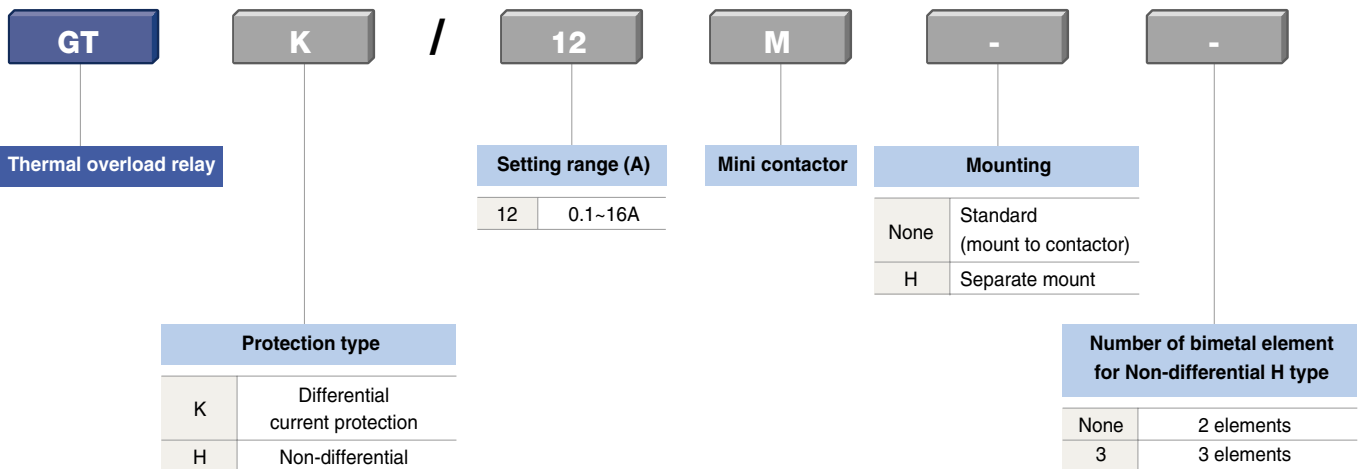

2-pole Contactors

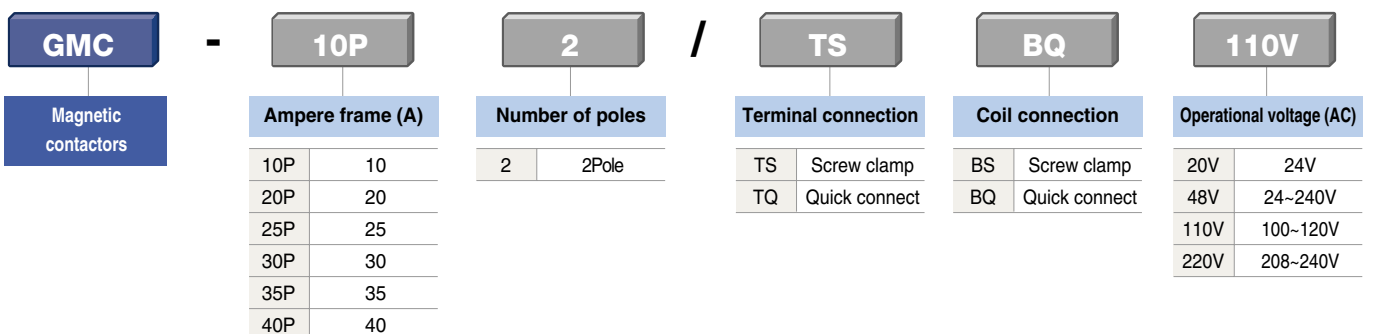

Quick selection table

Mini contactors

3NO main contacts
1 auxiliary contacts



Screw clamp type

Fast-on type

Cage clamp type

Solder pin type

Frame size		6A		9A		12A		16A	
Screw clamp type	AC coil	GMC-6M		GMC-9M		GMC-12M		GMC-16M	
	DC coil	GMD-6M		GMD-9M		GMD-12M		GMD-16M	
Fast-on type	AC coil	GMC-6MF		GMC-9MF		GMC-12MF		GMC-16MF	
	DC coil	GMD-6MF		GMD-9MF		GMD-12MF		GMD-16MF	
Cage clamp type	AC coil	GMC-6MC		GMC-9MC		GMC-12MC		GMC-16MC	
	DC coil	GMD-6MC		GMD-9MC		GMD-12MC		GMD-16MC	
Solder pin type	AC coil	GMC-6MP		GMC-9MP		GMC-12MP		GMC-16MP	
	DC coil	GMD-6MP		GMD-9MP		GMD-12MP		GMD-16MP	
Ratings / IEC60947-4		kW	A	kW	A	kW	A	kW	A
AC1		20		20		20		20	
AC3	200/240V	1.5	7	2.2	9	3	12	4	15
	380/440V	2.2	6	4	9	5.5	12	7.5	16
	500/550V	3	5	3.7	6	4	7	5.5	9
	690V	3	4	4	5	4	5	4	5
Ratings / UL508		hp	A	hp	A	hp	A	hp	A
continuous current		I _{th} = 20A (maximum for cage clamp type is 10A)							
single phase	120V	1/2		1/2		1 *		-	
	230V/240V	1		1.5		2 **		-	
three phase	240V	1.5		3		3		-	
	480V	3		5		7.5 ***		-	
	600V	3		5		7.5		-	
Wire Range : Copper, 75°C, Stranded, 18-12AWG									
NEMA size		00		00		00		0	
Additional auxiliary contacts		Screw clamp type		Fast-on type		Cage clamp type		Solder pin type	
2-pole, Front mount	AU-2M			AU-2MF		AU-2MC			
	AU-4M			AU-4MF		AU-4MC			
4-pole, Front mount	AU-1M			AU-1MF		AU-1MC			
2-pole, Side mount									

Note) * = 1/2 for cage clamp type, ** = 1.5hp for cage clamp type, *** = 5hp for cage clamp type
16AF : not approved from UL

Overload Relays

Bimetallic style Type GT Class 10A	 GT-12M	Setting ranges (A) 0.1 - 0.16 0.16 - 0.25 0.25 - 0.4 0.4 - 0.63 0.63 - 1 1 - 1.6 1.6 - 2.5 2.5 - 4	4 - 6 5 - 8 6 - 9 7 - 10 9 - 13 12 - 16	 Base for separate mount
	Differential	GTK-12M		
	Non-differential (3-heater)	GTH-12M/3		
	Non-differential (2-heater)	GTH-12M		

Contactors

- For motor control
- 3 main plus 1 auxiliary contacts
- Coil voltage : AC

Circuit diagram

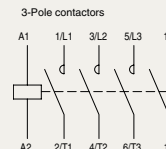

Screw clamp connection types



Frame size	AC3 ratings (IEC60947-4)				AC1 rating lth	Auxiliary contact (standard)	Type
	220 ~ 240V	380 ~ 440V	500 ~ 550V	690V			
6A	1.5kW 7A	2.2kW 6A	3kW 5A	3kW 4A	20A	1NO or 1NC	GMC-6M
9A	2.2kW 9A	4kW 9A	3.7kW 6A	4kW 5A	20A	1NO or 1NC	GMC-9M
12A	3kW 12A	5.5kW 12A	4kW 7A	4kW 5A	20A	1NO or 1NC	GMC-12M
16A	4kW 15A	7.5kW 16A	5.5kW 9A	4kW 5A	20A	1NO or 1NC	GMC-16M

Fast-on connection types



Frame size	AC3 ratings (IEC60947-4)				AC1 rating lth	Auxiliary contact (standard)	Type
	220 ~ 240V	380 ~ 440V	500 ~ 550V	690V			
6A	1.5kW 7A	2.2kW 6A	3kW 5A	3kW 4A	20A	1NO or 1NC	GMC-6MF
9A	2.2kW 9A	4kW 9A	3.7kW 6A	4kW 5A	20A	1NO or 1NC	GMC-9MF
12A	3kW 12A	5.5kW 12A	4kW 7A	4kW 5A	20A	1NO or 1NC	GMC-12MF
16A	4kW 15A	7.5kW 16A	5.5kW 9A	4kW 5A	20A	1NO or 1NC	GMC-16MF

Coil voltage, AC 50/60Hz

24, 36, 42, 48, 110, 115, 120, 127, 200 / 208, 220, 220 / 230, 230 / 240, 256, 277, 380 / 400, 400, 440, 480, 500, 550V AC

Performance (at 440VAC)

Frame size	6A	9A	12A	16A
Operation current	6A	9A	12A	16A
Making current	72A	108A	144A	180A
Breaking current	60A	90A	120A	150A
Operation cycle	1800 operations/hour			
Endurance	• Electrical : 1 mil. operations • Mechanical : 12 mil. operations			

Note) 16A frame is not UL listed item.

Coil characteristic

Coil voltage	AC
Coil consumption (W)	2
Inrush	32VA
Sealed	6VA
Closing voltage (%)	80~110
Opening voltage (%)	30~40
Closing time (ms)	10~20
Opening time (ms)	35~45

Certificate
CE, ULcUL

Contactors

- For motor control
- 3 main plus 1 auxiliary contacts
- Coil voltage : AC

Circuit diagram

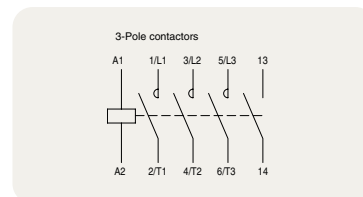

Cage clamp connection types



Frame size	AC3 ratings (IEC60947-4)				AC1 rating lth	Auxiliary contact (standard)	Type
	220 ~ 240V	380 ~ 440V	500 ~ 550V	690V			
6A	1.5kW	2.2kW	3kW	3kW	20A	1NO or 1NC	GMC-6MC
	7A	6A	5A	4A			
9A	2.2kW	4kW	3.7kW	4kW	20A	1NO or 1NC	GMC-9MC
	9A	9A	6A	5A			
12A	3kW	5.5kW	4kW	4kW	20A	1NO or 1NC	GMC-12MC
	12A	12A	7A	5A			
16A	4kW	7.5kW	5.5kW	4kW	20A	1NO or 1NC	GMC-16MC
	15A	16A	9A	5A			

Solder pin connection types



Frame size	AC3 ratings (IEC60947-4)				AC1 rating lth	Auxiliary contact (standard)	Type
	220 ~ 240V	380 ~ 440V	500 ~ 550V	690V			
6A	1.5kW	2.2kW	3kW	3kW	20A	1NO or 1NC	GMC-6MP
	7A	6A	5A	4A			
9A	2.2kW	4kW	3.7kW	4kW	20A	1NO or 1NC	GMC-9MP
	9A	9A	6A	5A			
12A	3kW	5.5kW	4kW	4kW	20A	1NO or 1NC	GMC-12MP
	12A	12A	7A	5A			
16A	4kW	7.5kW	5.5kW	4kW	20A	1NO or 1NC	GMC-16MP
	15A	16A	9A	5A			

Coil voltage, AC 50/60Hz

24, 36, 42, 48, 110, 115, 120, 127, 200 / 208, 220, 220 / 230, 230 / 240, 256, 277, 380 / 400, 400, 440, 480, 500, 550V AC

Ordering information

Type, Auxiliary contact and Coil voltage

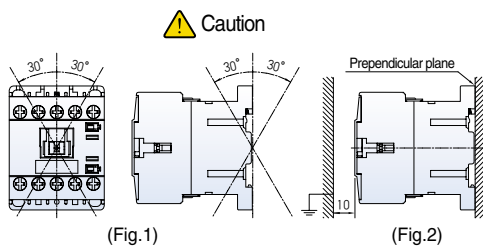

Caution

(Fig.1)

(Fig.2)

Certificate
CE, ULcUL

*Even installing direction takes the direction of Fig.1 to perpendicular, ip to the direction of the 30°.
Keep the distance more than 10mm with arc space shown Fig.2

Contactors

- For motor control
- 3 main plus 1 auxiliary contacts
- Coil voltage : DC

Circuit diagram

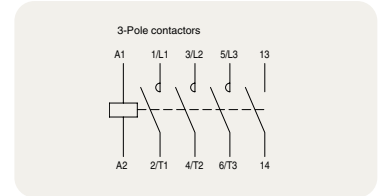

Screw clamp connection types



Frame size	AC3 ratings (IEC60947-4)				AC1 rating lth	Auxiliary contact (standard)	Type
	220 ~ 240V	380 ~ 440V	500 ~ 550V	690V			
6A	1.5kW 7A	2.2kW 6A	3kW 5A	3kW 4A	20A	1NO or 1NC	GMD-6M
9A	2.2kW 9A	4kW 9A	3.7kW 6A	4kW 5A	20A	1NO or 1NC	GMD-9M
12A	3kW 12A	5.5kW 12A	4kW 7A	4kW 5A	20A	1NO or 1NC	GMD-12M
16A	4kW 15A	7.5kW 16A	5.5kW 9A	4kW 5A	20A	1NO or 1NC	GMD-16M

Fast-on connection types



Frame size	AC3 ratings (IEC60947-4)				AC1 rating lth	Auxiliary contact (standard)	Type
	220 ~ 240V	380 ~ 440V	500 ~ 550V	690V			
6A	1.5kW 7A	2.2kW 6A	3kW 5A	3kW 4A	20A	1NO or 1NC	GMD-6MF
9A	2.2kW 9A	4kW 9A	3.7kW 6A	4kW 5A	20A	1NO or 1NC	GMD-9MF
12A	3kW 12A	5.5kW 12A	4kW 7A	4kW 5A	20A	1NO or 1NC	GMD-12MF
16A	4kW 15A	7.5kW 16A	5.5kW 9A	4kW 5A	20A	1NO or 1NC	GMD-16MF

Coil voltage, DC

- ① Standard type : 12, 20, 24, 36, 42, 48, 60, 72, 110, 120, 125, 220, 240, 250V DC
- ② Low consumption type : 12, 20, 24, 48, 72, 110, 120V DC(Low)
- ③ Wide Voltage : 12, 20, 24, 48, 72, 110, 12V DC(Wide)

Ordering information

Type, Auxiliary contact and Coil voltage

Coil characteristic

Coil voltage	DC		
	Standard	Low consumption	Wide voltage
Coil consumption (W)	3	1.2	2
Inrush	3W	1.2W	2W
Sealed	3W	1.2W	2W
Closing voltage (%)	80~110	80~125	70~125
Opening voltage (%)	10~30	10~30	10~30
Closing time (ms)	40~50	40~50	40~50
Opening time (ms)	35~45	35~45	35~45

Certificate
CE, ULcUL

Contactors

- For motor control
- 3 main plus 1 auxiliary contacts
- Coil voltage : DC

Circuit diagram

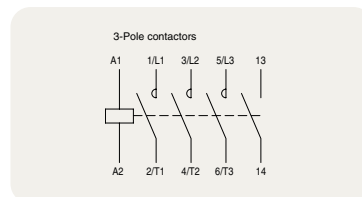

Cage clamp connection types



Frame size	AC3 ratings (IEC60947-4)				AC1 rating Ith	Auxiliary contact (standard)	Type
	220 ~ 240V	380 ~ 440V	500 ~ 550V	690V			
6A	1.5kW 7A	2.2kW 6A	3kW 5A	3kW 4A	20A	1NO or 1NC	GMD-6MC
9A	2.2kW 9A	4kW 9A	3.7kW 6A	4kW 5A	20A	1NO or 1NC	GMD-9MC
12A	3kW 12A	5.5kW 12A	4kW 7A	4kW 5A	20A	1NO or 1NC	GMD-12MC
16A	4kW 15A	7.5kW 16A	5.5kW 9A	4kW 5A	20A	1NO or 1NC	GMD-16MC

Solder pin connection types



Frame size	AC3 ratings (IEC60947-4)				AC1 rating Ith	Auxiliary contact (standard)	Type
	220 ~ 240V	380 ~ 440V	500 ~ 550V	690V			
6A	1.5kW 7A	2.2kW 6A	3kW 5A	3kW 4A	20A	1NO or 1NC	GMD-6MP
9A	2.2kW 9A	4kW 9A	3.7kW 6A	4kW 5A	20A	1NO or 1NC	GMD-9MP
12A	3kW 12A	5.5kW 12A	4kW 7A	4kW 5A	20A	1NO or 1NC	GMD-12MP
16A	4kW 15A	7.5kW 16A	5.5kW 9A	4kW 5A	20A	1NO or 1NC	GMD-16MP

Coil voltage, DC

- ① Standard type : 12, 20, 24, 36, 42, 48, 60, 72, 110, 120, 125, 220, 240, 250V DC
- ② Low consumption type : 12, 20, 24, 48, 72, 110, 120V DC(Low)
- ③ Wide Voltage : 12, 20, 24, 48, 72, 110, 12V DC(Wide)

Ordering information

Type, Auxiliary contact and Coil voltage

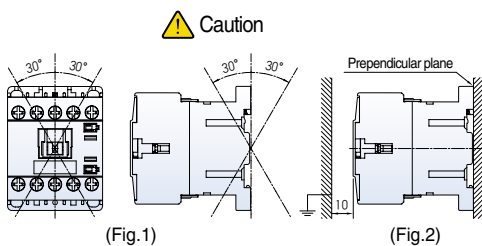

*Even installing direction takes the direction of Fig.1 to perpendicular, ip to the direction of the 30°.
Keep the distance more than 10mm with arc space shown Fig.2

Certificate
CE, ULcUL

Starters

- Open types
- Direct (Full voltage) types
- Coil voltage : AC
- Contactors : screw clamp connection types
- Overload relays : differential or non-differential types

AC coil contactor + Differential type overload relay

Devices combined		AC3 ratings (IEC60947-4)				Auxiliary contacts	Starter Type
Contactor (AC coil)	Overload (differential)	220 ~ 240V	380 ~ 440V	500 ~ 550V	690V		
GMC-6M	GTK-12M	1.5kW 7A	2.2kW 6A	3kW 5A	3kW 4A	1NO or 1NC	GMS-6M/K
GMC-9M	GTK-12M	2.2kW 9A	4kW 9A	3.7kW 6A	4kW 5A	1NO or 1NC	GMS-9M/K
GMC-12M	GTK-12M	3kW 12A	5.5kW 12A	4kW 7A	4kW 5A	1NO or 1NC	GMS-12M/K
GMC-16M	GTK-12M	4kW 15A	7.5kW 16A	5.5kW 9A	4kW 5A	1NO or 1NC	GMS-16M/K



AC coil contactor + Non-differential type overload relay

Devices combined		AC3 ratings (IEC60947-4)				Auxiliary contacts	Starter Type
Contactor (AC coil)	Overload (differential)	220 ~ 240V	380 ~ 440V	500 ~ 550V	690V		
GMC-6M	GTH-12M/3	1.5kW 7A	2.2kW 6A	3kW 5A	3kW 4A	1NO or 1NC	GMS-6M
GMC-9M	GTH-12M/3	2.2kW 9A	4kW 9A	3.7kW 6A	4kW 5A	1NO or 1NC	GMS-9M
GMC-12M	GTH-12M/3	3kW 12A	5.5kW 12A	4kW 7A	4kW 5A	1NO or 1NC	GMS-12M
GMC-16M	GTH-12M/3	4kW 15A	7.5kW 16A	5.5kW 9A	4kW 5A	1NO or 1NC	GMS-16M

Coil voltage, AC 50/60Hz

24, 36, 42, 48, 110, 115, 120, 127, 200 / 208, 220, 220 / 230, 230 / 240, 256, 277, 380 / 400, 400, 440, 480, 500, 550V AC

Ordering information

Type, Auxiliary contact and Coil voltage
Overload relay setting range

Certificate
CE, ULcUL

Reversing contactors

- For motor control
- Mechanically interlocked
- Coil voltage : AC

Screw clamp connection types



Frame size	AC3 ratings (IEC60947-4)				AC1 rating lth	Auxiliary contact (standard)	Type
	220 ~ 240V	380 ~ 440V	500 ~ 550V	690V			
6A	1.5kW 7A	2.2kW 6A	3kW 5A	3kW 4A	20A	1NO or 1NC	GMC-6MR
9A	2.2kW 9A	4kW 9A	3.7kW 6A	4kW 5A	20A	1NO or 1NC	GMC-9MR
12A	3kW 12A	5.5kW 12A	4kW 7A	4kW 5A	20A	1NO or 1NC	GMC-12MR
16A	4kW 15A	7.5kW 16A	5.5kW 9A	4kW 5A	20A	1NO or 1NC	GMC-16MR

Fast-on connection types



Frame size	AC3 ratings (IEC60947-4)				AC1 rating lth	Auxiliary contact (standard)	Type
	220 ~ 240V	380 ~ 440V	500 ~ 550V	690V			
6A	1.5kW 7A	2.2kW 6A	3kW 5A	3kW 4A	20A	1NO or 1NC	GMC-6MFR
9A	2.2kW 9A	4kW 9A	3.7kW 6A	4kW 5A	20A	1NO or 1NC	GMC-9MFR
12A	3kW 12A	5.5kW 12A	4kW 7A	4kW 5A	20A	1NO or 1NC	GMC-12MFR
16A	4kW 15A	7.5kW 16A	5.5kW 9A	4kW 5A	20A	1NO or 1NC	GMC-16MFR

Coil voltage, AC 50/60Hz

24, 36, 42, 48, 110, 115, 120, 127, 200 / 208, 220, 220 / 230, 230 / 240, 256, 277, 380 / 400, 400, 440, 480, 500, 550V AC

Certificate
CE, ULcUL

Ordering information

Type, Auxiliary contact and Coil voltage

Reversing contactors

- For motor control
- Mechanically interlocked
- Coil voltage : AC

Cage clamp connection types



Frame size	AC3 ratings (IEC60947-4)				AC1 rating Ith	Auxiliary contact (standard)	Type
	220 ~ 240V	380 ~ 440V	500 ~ 550V	690V			
6A	1.5kW 7A	2.2kW 6A	3kW 5A	3kW 4A	20A	1NO or 1NC	GMC-6MCR
9A	2.2kW 9A	4kW 9A	3.7kW 6A	4kW 5A	20A	1NO or 1NC	GMC-9MCR
12A	3kW 12A	5.5kW 12A	4kW 7A	4kW 5A	20A	1NO or 1NC	GMC-12MCR
16A	4kW 15A	7.5kW 16A	5.5kW 9A	4kW 5A	20A	1NO or 1NC	GMC-16MCR

Solder pin connection types



Frame size	AC3 ratings (IEC60947-4)				AC1 rating Ith	Auxiliary contact (standard)	Type
	220 ~ 240V	380 ~ 440V	500 ~ 550V	690V			
6A	1.5kW 7A	2.2kW 6A	3kW 5A	3kW 4A	20A	1NO or 1NC	GMC-6MPR
9A	2.2kW 9A	4kW 9A	3.7kW 6A	4kW 5A	20A	1NO or 1NC	GMC-9MPR
12A	3kW 12A	5.5kW 12A	4kW 7A	4kW 5A	20A	1NO or 1NC	GMC-12MPR
16A	4kW 15A	7.5kW 16A	5.5kW 9A	4kW 5A	20A	1NO or 1NC	GMC-16MPR

Coil voltage, AC 50/60Hz

24, 36, 42, 48, 110, 115, 120, 127, 200 / 208, 220, 220 / 230, 230 / 240, 256, 277, 380 / 400
400, 440, 480, 500, 550V AC

Certificate
CE, ULcUL

Ordering information

Type, Auxiliary contact and Coil voltage

Reversing contactors

- For motor control
- Mechanically interlocked
- Coil voltage : DC

Screw clamp connection types



Frame size	AC3 ratings (IEC60947-4)				AC1 rating lth	Auxiliary contact (standard)	Type
	220 ~ 240V	380 ~ 440V	500 ~ 550V	690V			
6A	1.5kW 7A	2.2kW 6A	3kW 5A	3kW 4A	20A	1NO or 1NC	GMD-6MR
9A	2.2kW 9A	4kW 9A	3.7kW 6A	4kW 5A	20A	1NO or 1NC	GMD-9MR
12A	3kW 12A	5.5kW 12A	4kW 7A	4kW 5A	20A	1NO or 1NC	GMD-12MR
16A	4kW 15A	7.5kW 16A	5.5kW 9A	4kW 5A	20A	1NO or 1NC	GMD-16MR

Fast-on connection types



Frame size	AC3 ratings (IEC60947-4)				AC1 rating lth	Auxiliary contact (standard)	Type
	220 ~ 240V	380 ~ 440V	500 ~ 550V	690V			
6A	1.5kW 7A	2.2kW 6A	3kW 5A	3kW 4A	20A	1NO or 1NC	GMD-6MFR
9A	2.2kW 9A	4kW 9A	3.7kW 6A	4kW 5A	20A	1NO or 1NC	GMD-9MFR
12A	3kW 12A	5.5kW 12A	4kW 7A	4kW 5A	20A	1NO or 1NC	GMD-12MFR
16A	4kW 15A	7.5kW 16A	5.5kW 9A	4kW 5A	20A	1NO or 1NC	GMD-16MFR

Coil voltage, DC

- ① Standard type : 12, 20, 24, 36, 42, 48, 60, 72, 110, 120, 125, 220, 240, 250V DC
- ② Low consumption type : 12, 20, 24, 48, 72, 110, 120V DC(Low)
- ③ Wide Voltage : 12, 20, 24, 48, 72, 110, 12V DC(Wide)

Ordering information

Type, Auxiliary contact and Coil voltage

Certificate
CE, ULcUL

Reversing contactors

- For motor control
- Mechanically interlocked
- Coil voltage : DC

Cage clamp connection types



Frame size	AC3 ratings (IEC60947-4)				AC1 rating Ith	Auxiliary contact (standard)	Type
	220 ~ 240V	380 ~ 440V	500 ~ 550V	690V			
6A	1.5kW 7A	2.2kW 6A	3kW 5A	3kW 4A	20A	1NO or 1NC	GMD-6MCR
9A	2.2kW 9A	4kW 9A	3.7kW 6A	4kW 5A	20A	1NO or 1NC	GMD-9MCR
12A	3kW 12A	5.5kW 12A	4kW 7A	4kW 5A	20A	1NO or 1NC	GMD-12MCR
16A	4kW 15A	7.5kW 16A	5.5kW 9A	4kW 5A	20A	1NO or 1NC	GMD-16MCR

Solder pin connection types



Frame size	AC3 ratings (IEC60947-4)				AC1 rating Ith	Auxiliary contact (standard)	Type
	220 ~ 240V	380 ~ 440V	500 ~ 550V	690V			
6A	1.5kW 7A	2.2kW 6A	3kW 5A	3kW 4A	20A	1NO or 1NC	GMD-6MSR
9A	2.2kW 9A	4kW 9A	3.7kW 6A	4kW 5A	20A	1NO or 1NC	GMD-9MSR
12A	3kW 12A	5.5kW 12A	4kW 7A	4kW 5A	20A	1NO or 1NC	GMD-12MSR
16A	4kW 15A	7.5kW 16A	5.5kW 9A	4kW 5A	20A	1NO or 1NC	GMD-16MSR

Coil voltage, DC

- ① Standard type : 12, 20, 24, 36, 42, 48, 60, 72, 110, 120, 125, 220, 240, 250V DC
- ② Low consumption type : 12, 20, 24, 48, 72, 110, 120V DC(Low)
- ③ Wide Voltage : 12, 20, 24, 48, 72, 110, 12V DC(Wide)

Ordering information

Type, Auxiliary contact and Coil voltage

Certificate
CE, ULcUL

Bimetallic style

Description



GT-12M

- Direct mount on the mini contactors with screw clamp connection.
contactor types : GMC(D)-6M, GMC(D)-9M,
GMC(D)-12M, GMC(D)-16M,
- DIN rail or screw mountable with the optional base AZ-22H
- Small physical size : 44 mm wide
- 1NO+1NC trip contacts
- Trip class 10A according to IEC60947-4-1
- Differential current/Phase failure protection : GTK types
- Non-differential GTH types are available for the economic solution
- Ambient compensated -5 to 40 °C
- Manual/Automatic reset convertible.
- Remote reset is optional
- Trip free designed

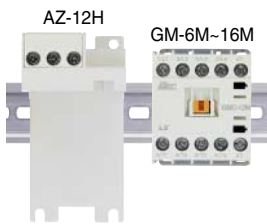

Separate mount

Direct mount



GT-12M

Catalog No.

Setting ranges(A)	Differential type	Non-differential type	
	3-heater	3-heater	2-heater
	0.1 - 0.16	GTK-12M • 0.14	GTH-12M/3 • 0.14
0.16 - 0.25	GTK-12M • 0.21	GTH-12M/3 • 0.21	GTH-12M • 0.21
0.25 - 0.4	GTK-12M • 0.33	GTH-12M/3 • 0.33	GTH-12M • 0.33
0.4 - 0.63	GTK-12M • 0.52	GTH-12M/3 • 0.52	GTH-12M • 0.52
0.63 - 1	GTK-12M • 0.82	GTH-12M/3 • 0.82	GTH-12M • 0.82
1 - 1.6	GTK-12M • 1.3	GTH-12M/3 • 1.3	GTH-12M • 1.3
1.6 - 2.5	GTK-12M • 2.1	GTH-12M/3 • 2.1	GTH-12M • 2.1
2.5 - 4	GTK-12M • 3.3	GTH-12M/3 • 3.3	GTH-12M • 3.3
4 - 6	GTK-12M • 5	GTH-12M/3 • 5	GTH-12M • 5
5 - 8	GTK-12M • 6.5	GTH-12M/3 • 6.5	GTH-12M • 6.5
6 - 9	GTK-12M • 7.5	GTH-12M/3 • 7.5	GTH-12M • 7.5
7 - 10	GTK-12M • 8.5	GTH-12M/3 • 8.5	GTH-12M • 8.5
9 - 13	GTK-12M • 12	GTH-12M/3 • 12	GTH-12M • 12
12 - 16	GTK-12M • 14	GTH-12M/3 • 14	GTH-12M • 14

Auxiliary (Trip) contact rating

	AC15(11) duty			DC13(11) duty	
	110V	220V	550V	110V	220V
	2.5(0.3)A	2(0.3)A	1(0.3)A	0.28A	0.14A

Note) Values of () are the ratings of NO contact under auto reset mode.

Certificate
CE, ULcUL

2-pole DC Contactors

Description

- Two normally open main contacts for DC circuit
- Positive and negative poles indicated on the front plate
- Eternal magnet installed for the effective arc extinguishing
- DIN rail or screw mountable
- 2NO+2NC Auxiliary contacts built-in as standard
- AC/DC control voltage

Selection



Type		Number of contacts in series	DC2, 4 ratings			Continuous current, Ith	Auxiliary contacts
AC coil	DC coil		110V	220V	440V		
SMM-30P	SMM-30DP	1 ①	2.2kW 30A	3.7kW 20A	2.2kW 7.5A	50A	2NO+2NC
		2 ②	3.7kW 40A	5.5kW 30A	7.5kW 20A		
SMM-60P	SMM-60DP	1	5.5kW 60A	7.5kW 40A	5.5kW 15A	90A	2NO+2NC
		2	7.5kW 80A	11kW 60A	15kW 40A		
SMM-100P	SMM-100DP	1	7.5kW 100A	11kW 60A	15kW 20A	120A	2NO+2NC
		2	11kW 120A	18.5kW 100A	22kW 60A		

Ratings of auxiliary contacts

		AC duty			DC duty		
		110V	220V	550V	48V	110V	220V
Rated currents	Inductive load	6A	5A	3A	3A	1.2A	0.2A
	Resistive load	10A	10A	5A	2.5A	1A	
Continuous current, Ith		16A					

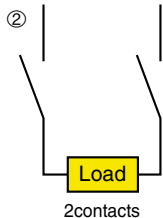
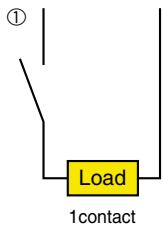

Performance

Contactor types	Breaking current				Making current	Endurance
	contacts in series	DC110V	DC220V	DC440V		
SMM-30P	1	120A	80A	30A	160A	Mechanical lifetime : 2.5 mil. operations
SMM-30DP	2	160A	120A	80A		
SMM-60P	1	240A	160A	60A	320A	Electrical lifetime : 0.5 mil. operations
SMM-60DP	2	320A	240A	160A		
SMM-100P	1	400A	240A	80A	480A	Operation cycle : 1200 operations/hour
SMM-100DP	2	480A	400A	240A		

Contactor coil voltage, AC 50/60Hz

48, 100/100~110, 110~120/115~120, 200/200~220, 220~240/230~240, 380~415/400~440V

Coil voltage, DC

24, 48, 100, 110, 200, 220V

Ordering information

Specify type and coil voltage

Example : SMM-30P, AC100V 50Hz

2-pole AC Contactors, Definite purpose

Features and specifications



The single pole contactor is small, light and economical. It is suitable for use in equipment of lower switching frequency such as heaters, lightning equipment and in motor control of air conditioners, refrigerators, drivers, pumps, compressors, industrial cleaner and etc.

- Space-Saving small and light Design
- Extended Range in same size enables its use in a wide range of application areas
- Sealed structure which Improves Noise
- Equipped with Operation Status display unit
- Rated current: 10, 20, 25, 30, 35, 40A (AC 220V Standard)

Type and rating



Type			GMC-10P2	GMC-20P2	GMC-25P2	GMC-30P2	GMC-35P2	GMC40P2	
			10A	20A	25A	30A	35A	40A	
Number of poles			2	2	2	2	2	2	
Main contact			2a	2a	2a	2a	2a	2a	
Rated insulation voltage, Ui			AC	690					
			DC	250					
Rating	AC3 ratings	Rated current (A)	200~220V	10	20	25	30	35	40
			380~440V	8	17	21	23	26	32
			500~550V	6	14	17	21	23	26
	AC1 lth (A)			20	30	35	40	45	50

Main contactor

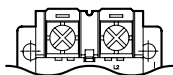

Screw clamp

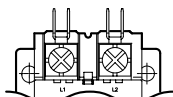

Quick connect

Coil contactor

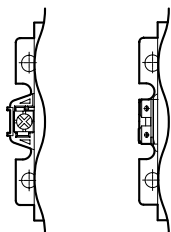

Screw clamp

Quick connect

Coil characteristics

Voltage (AC)	Input (VA)		Thermal dissipation (W)	Operation voltage (V)		Coil current (mA)	Operation time (ms)	
	Inrush	Sealed		Pick-up	Drop-out		Closing	Opening
24V 50/60Hz	35	6.0	2	18~20	10~15	263	40	30
48V 50/60Hz	35	6.0	2	36~40	19~27	131	40	30
100V 50/60Hz	35	6.0	2	74~81	39~57	63	40	30
110V 50/60Hz	35	6.0	2	78~90	50~64	57	40	30
120V 50/60Hz	35	6.0	2	90~100	52~66	53	40	30
200V 50/60Hz	35	6.0	2	155~165	80~115	32	40	30
220V 50/60Hz	35	6.0	2	160~175	90~120	29	40	30
230V 50/60Hz	35	6.0	2	165~180	110~130	27	40	30
240V 50/60Hz	35	6.0	2	168~185	110~135	26	40	30

Note) 1. Input VA is average value

2. The data above consists of test results at 60Hz, (20°C COLD status)

3. The contactor will operate between 85% and 110% of rated voltage. But when continuously Applied, the voltage should remain within the rated voltage.

Timer unit, AT-12M

- Electronic type
- ON/OFF time delay
- Front mount

Timer unit



Surge absorber unit



Electronic Timer

Type	Control voltage	Delay	Time	Applied contactors
AT-12M / IN	AC/DC 24~48V	ON	0.1~30s	GMC-6M~16M GMD-6M~16M
AT-12M / IF	AC/DC 24~48V	OFF	0.1~30s	GMC-6M~16M GMD-6M~16M
AT-12M / 2N	AC 100~220V	ON	0.1~30s	GMC-6M~16M GMD-6M~16M
AT-12M / 2F	AC 100~220V	OFF	0.1~30s	GMC-6M~16M GMD-6M~16M

Surge absorber unit, AS-12M

- Coil surge suppressor

Surge absorber unit



Type	Internal element	Operational voltage	Applied contactors
AS-12M / 1	Varistor	AC24~48V	GMC-6M~16M
AS-12M / 2		AC60~127V	
AS-12M / 3		AC200~240V	
AS-12M / 4		DC12~24V	GMD-6M~16M
AS-12M / 5		DC30~72V	
AS-12M / 6		DC100~127V	
AS-12M / 7		DC200~250V	

Separate mounting unit, AZ-12MH

- To mount a relay separately from a contactor
- Mountable on DIN rail or by screw fixing

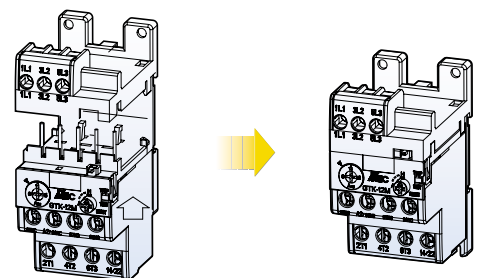

Interlock unit, AR-12M

consists of

- Mechanical interlock components
- Cable kits for line and load sides



Solder pin terminals

To modify the connection to Solder pin type from Screw clamp type
 Available for contactors and auxiliary contact blocks

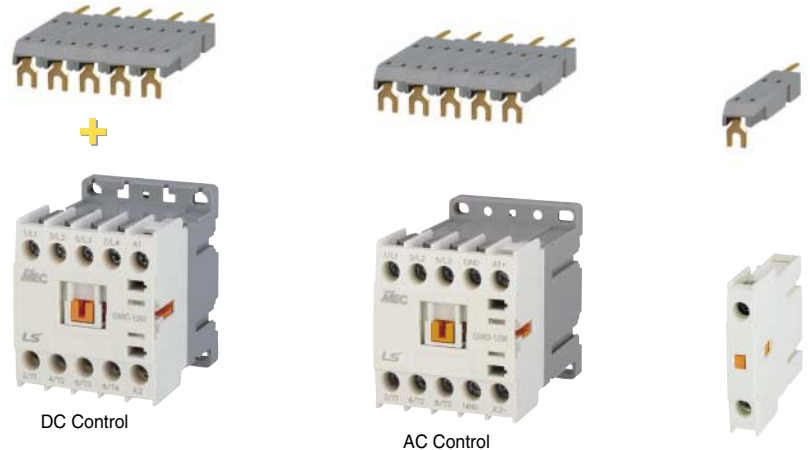

DC Control

AC Control



Dimensions

Mini contactors with Screw clamp type

- GMC-6M
- GMC-9M
- GMC-12M
- GMC-16M
- GMC-6M/4
- GMC-9M/4
- GMC-12M/4
- GMC-16M/4

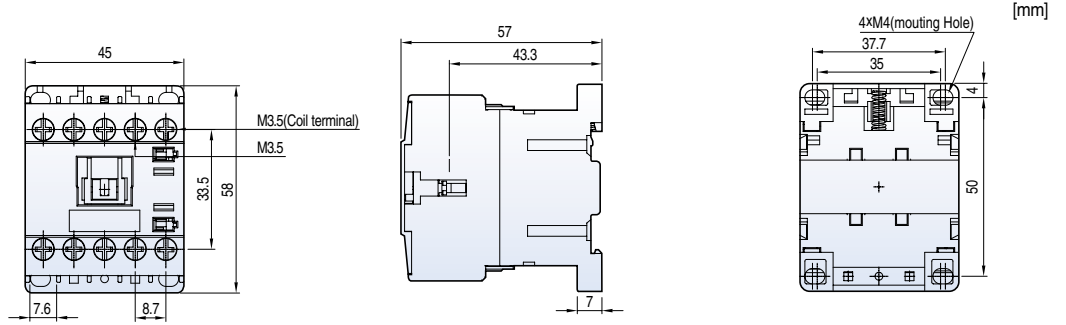

[mm]

0.17kg

- GMD-6M
- GMD-9M
- GMD-12M
- GMD-16M
- GMD-6M/4
- GMD-9M/4
- GMD-12M/4
- GMD-16M/4

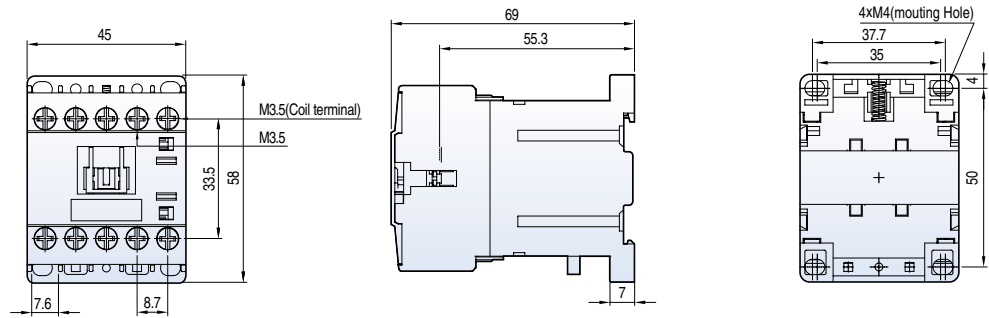

0.23kg

Circuit diagram

GMC-6M~16M, GMD-6M~16M

3-Pole contactors

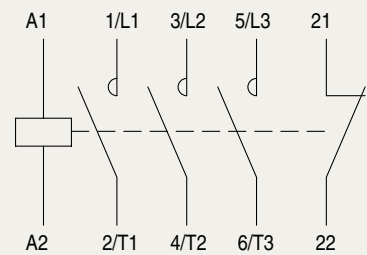
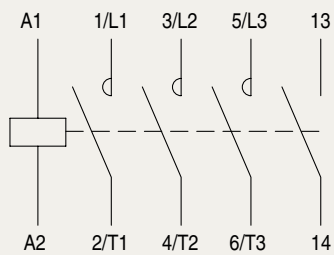

GMC-6M/4~16M/4, GMD-6M/4~16M/4

4-Pole contactors

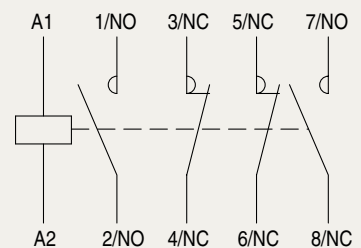
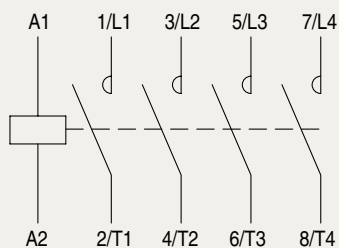

Mini contactors with Solder pin type

- GMC-6MP
- GMC-9MP
- GMC-12MP
- GMC-16MP
- GMC-6MP/4
- GMC-9MP/4
- GMC-12MP/4
- GMC-16MP/4

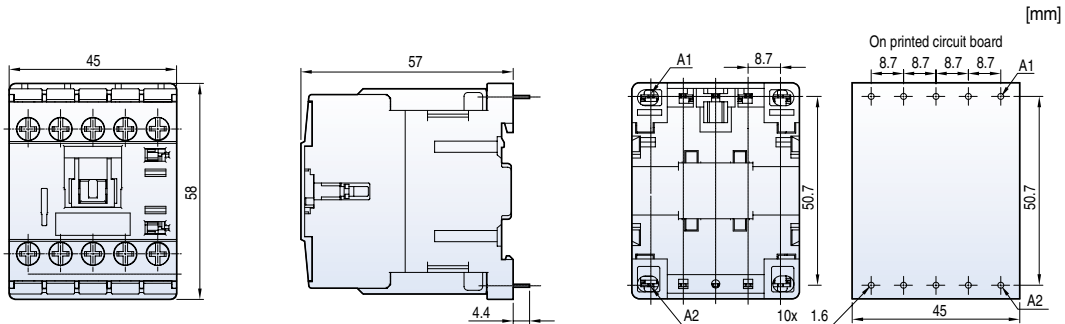

0.17kg

- GMD-6MP
- GMD-9MP
- GMD-12MP
- GMD-16MP
- GMD-6MP/4
- GMD-9MP/4
- GMD-12MP/4
- GMD-16MP/4

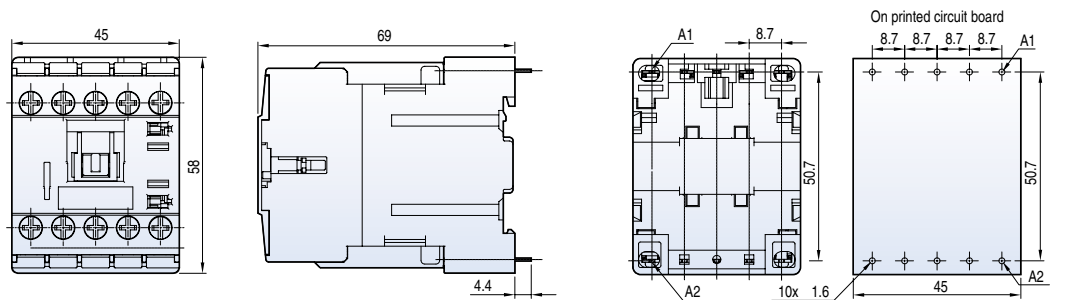

0.23kg

Circuit diagram

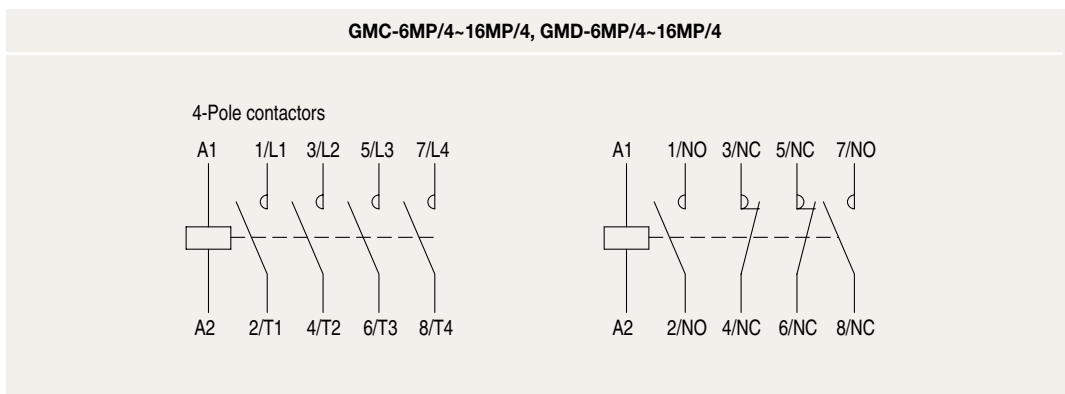
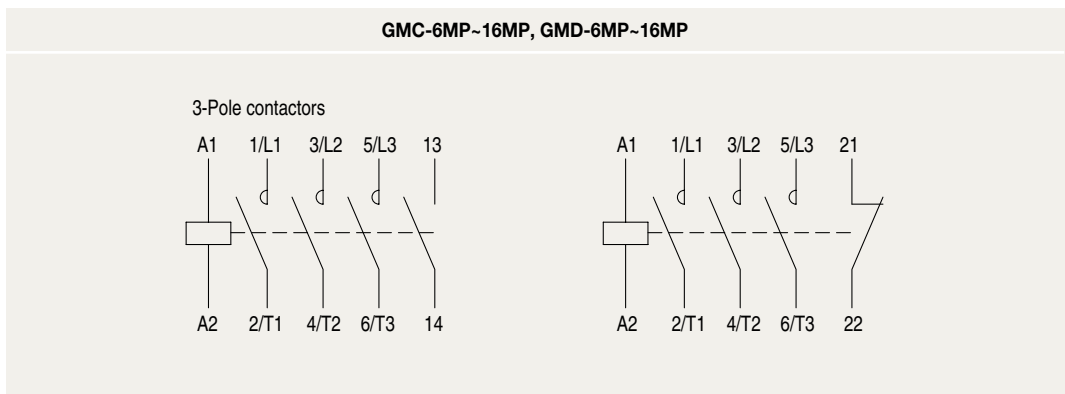

Dimensions

Mini contactors with Fast-on type

- GMC-6MF
- GMC-9MF
- GMC-12MF
- GMC-16MF
- GMC-6MF/4
- GMC-9MF/4
- GMC-12MF/4
- GMC-16MF/4

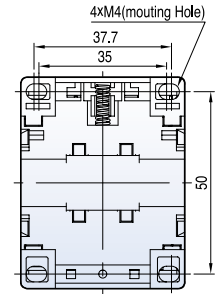
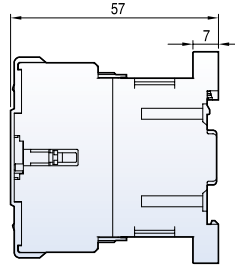
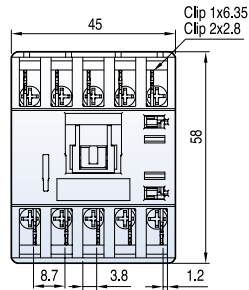

[mm]

0.18kg

- GMD-6MF
- GMD-9MF
- GMD-12MF
- GMD-16MF
- GMD-6MF/4
- GMD-9MF/4
- GMD-12MF/4
- GMD-16MF/4

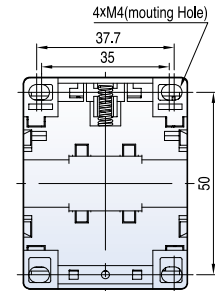
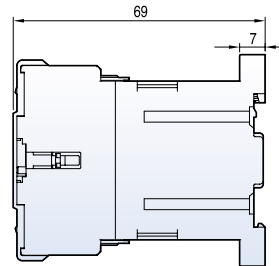
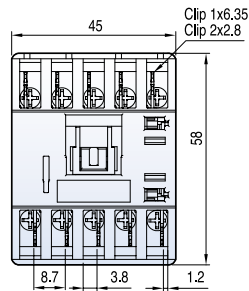

0.27kg

Circuit diagram

GMC-6MF-16MF, GMD-6MF-16MF

3-Pole contactors

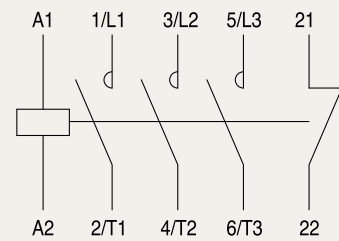
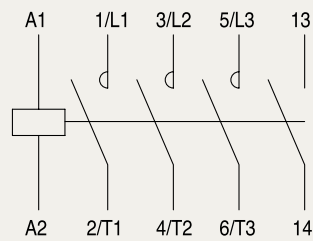

GMC-6MF/4-16MF/4, GMD-6MF/4-16MF/4

4-Pole contactors

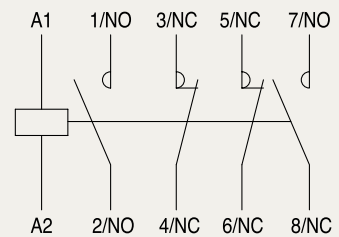
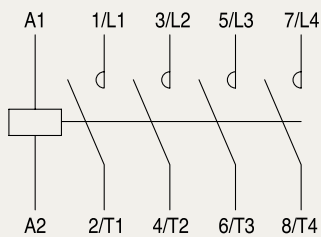

Mini contactors with Cage clamp type

- GMC-6MC
- GMC-9MC
- GMC-12MC
- GMC-16MC
- GMC-6MC/4
- GMC-9MC/4
- GMC-12MC/4
- GMC-16MC/4

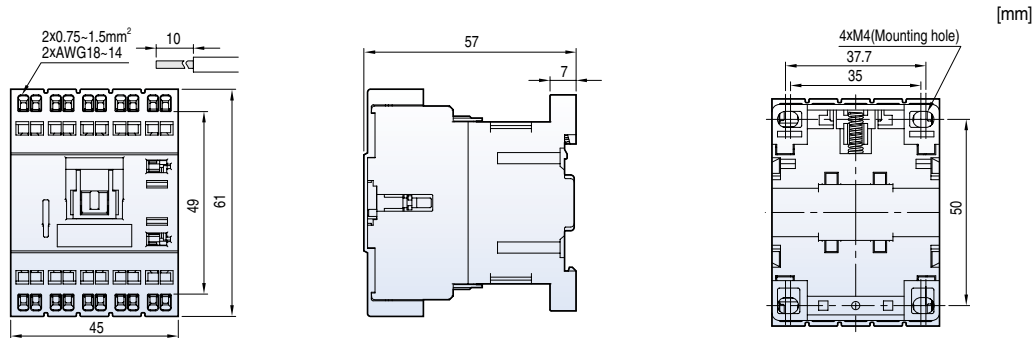

- GMD-6MC
- GMD-9MC
- GMD-12MC
- GMD-16MC
- GMD-6MC/4
- GMD-9MC/4
- GMD-12MC/4
- GMD-16MC/4

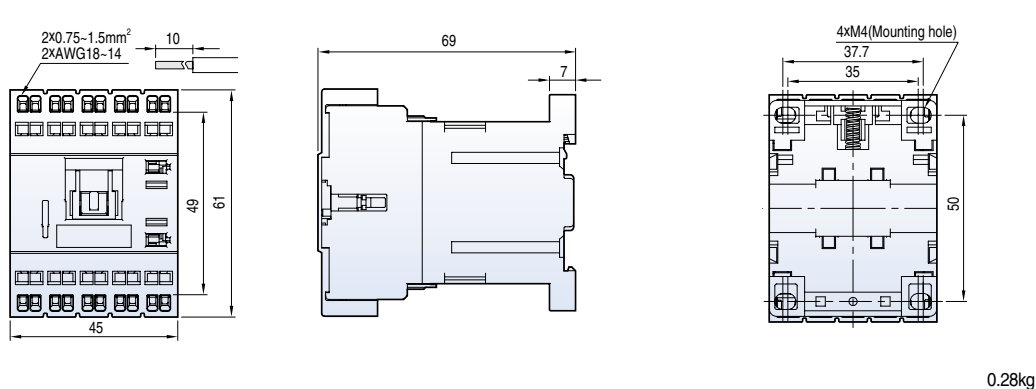

Circuit diagram

GMC-6MC~16MC, GMD-6MC~16MC

3-Pole contactors

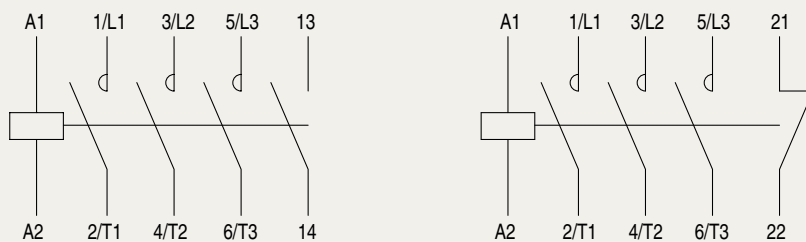

GMC-6MC/4~16MC/4, GMD-6MC/4~16MC/4

4-Pole contactors

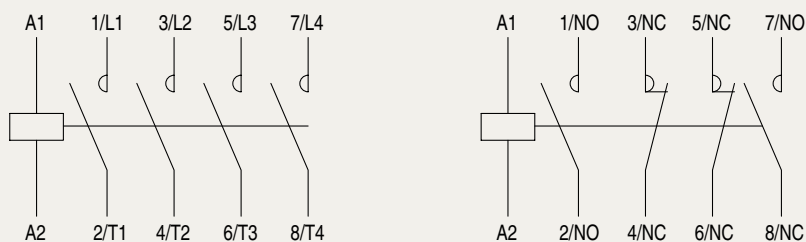

Dimensions

Mini contactors with Auxiliary contacts

- GMC-6M
- GMC-9M
- GMC-12M
- GMC-16M
- +
- AU-4M

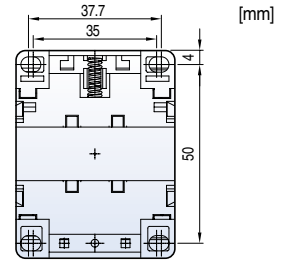
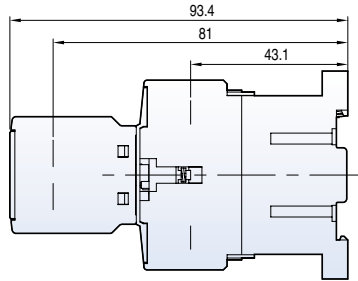
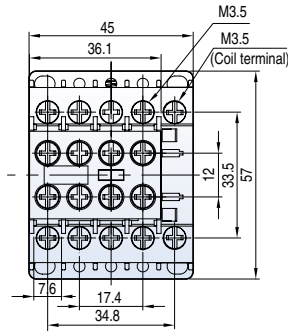

[mm]

0.21kg

- GMC-6M
- GMC-9M
- GMC-12M
- GMC-16M
- +
- 2 × AU-1M

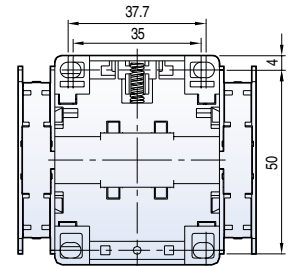
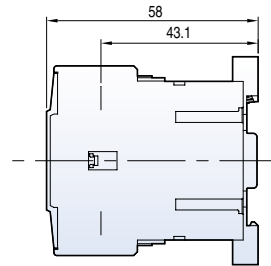
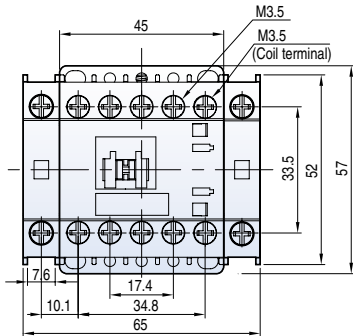

0.21kg

- GMC-6MP
- GMC-9MP
- GMC-12MP
- GMC-16MP
- +
- 2 × AU-1MP

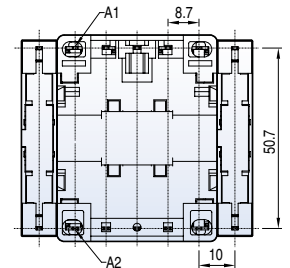
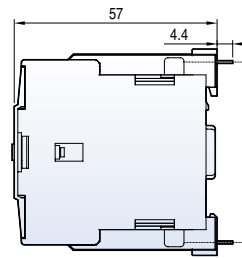
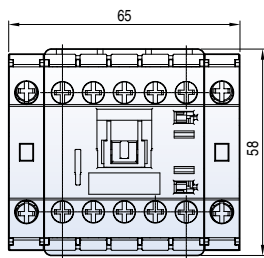

- GMC-6MF
- GMC-9MF
- GMC-12MF
- GMC-16MF
- +
- AU-4MF

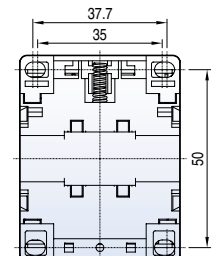
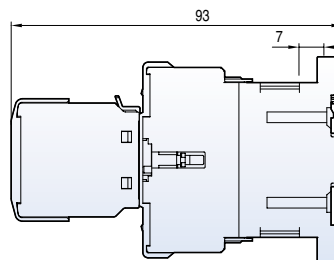
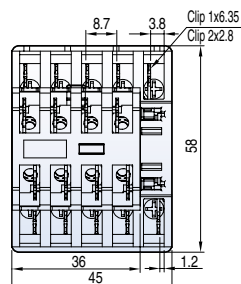

0.23kg

Mini contactors with Auxiliary contacts

- GMC-6MF
- GMC-9MF
- 2 × GMC-12MF
- GMC-16MF
- +
- AU-1MF

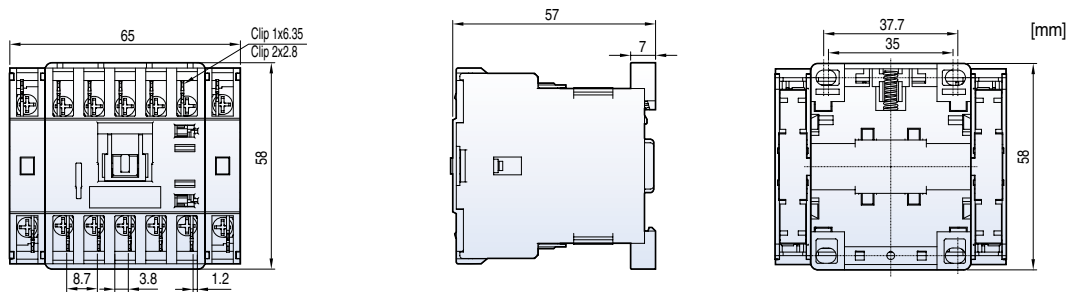

0.32kg

- GMC-6MC
- GMC-9MC
- GMC-12MC
- GMC-16MC
- +
- AU-4MC

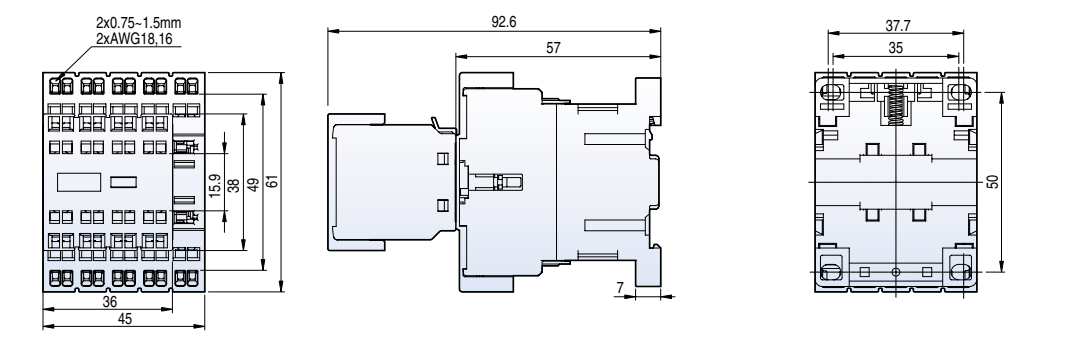

0.24kg

- GMC-6MC
- GMC-9MC
- 2 × GMC-12MC
- GMC-16MC
- +
- AU-1MC

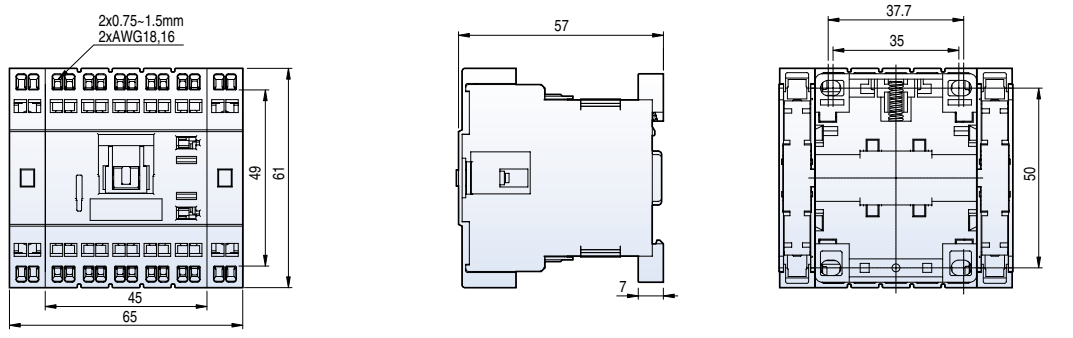

0.23kg

Dimensions

Mini contactors with external accessories

Metasol

- GMC-6M
- GMC-9M
- GMC-12M
- GMC-16M
- +
- AT-12M

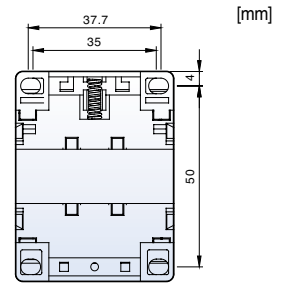
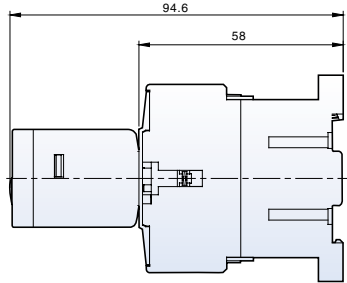
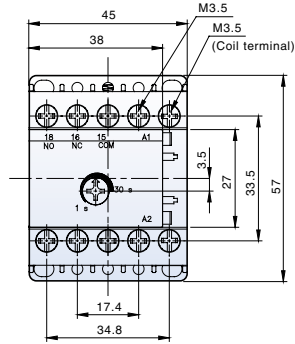

[mm]

0.21kg

- GMD-6M
- GMD-9M
- GMD-12M
- GMD-16M
- +
- AS-12M

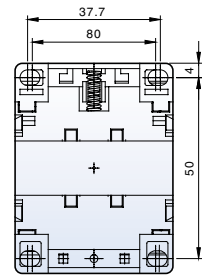
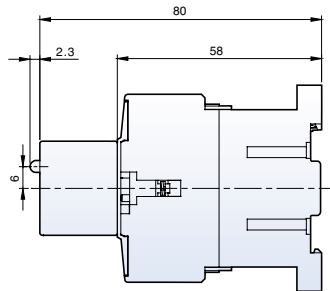
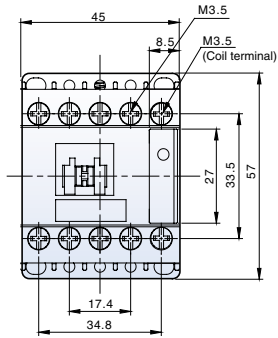

0.175kg

Thermal overload relays for Mini contactors

GTH(K)-12M

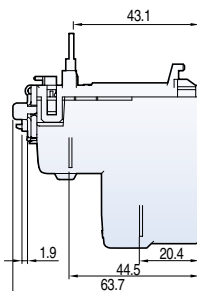
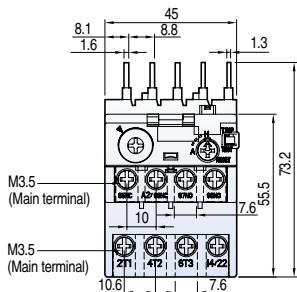

[mm]

0.1kg

GTH(K)-12MH

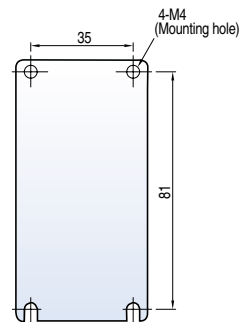
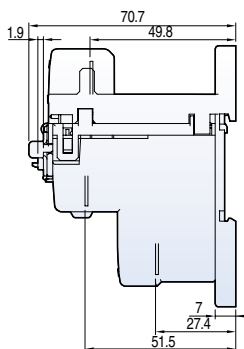
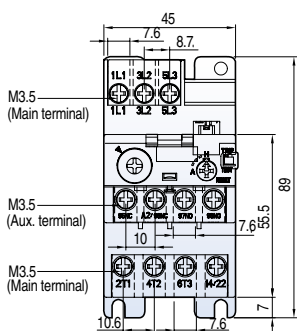

0.4kg

Dimensions

Mini motor starters, open

- GMS-6M
- GMS-9M
- GMS-12M
- GMS-16M

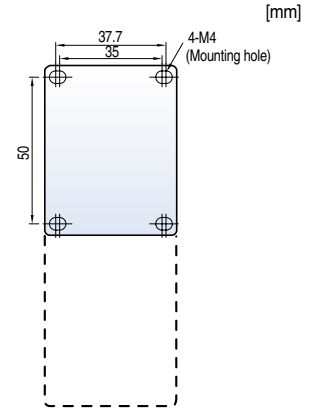
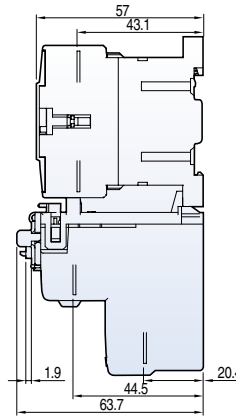
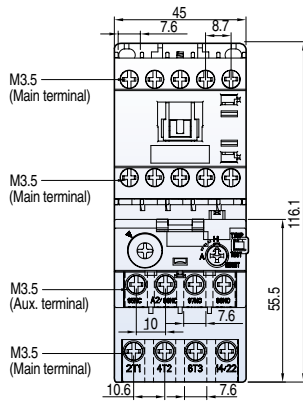

[mm]

0.26kg

- GMS-6MD
- GMS-9MD
- GMS-12MD
- GMS-16MD

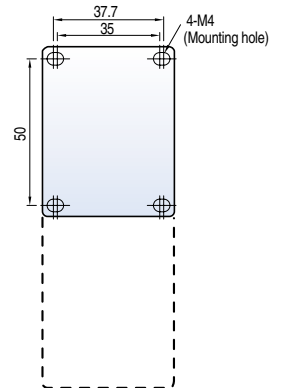
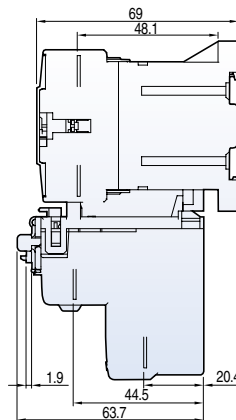
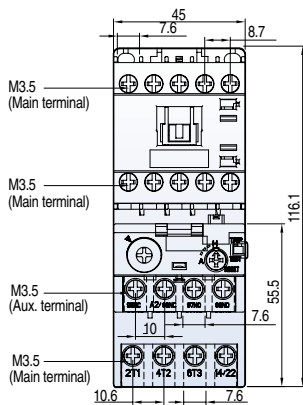

0.39kg

Mini contactor relays

[mm]

GMR-4M

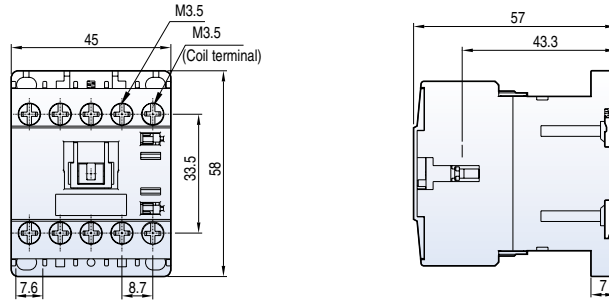

0.17kg

GMR-4MD

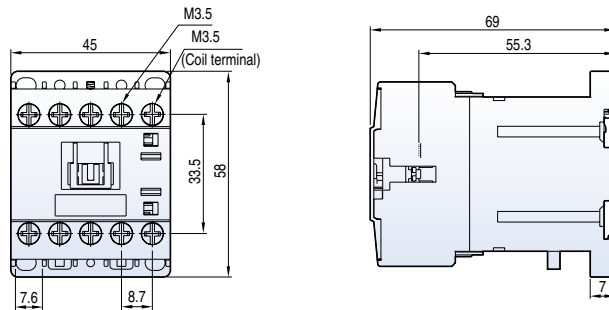

0.23kg

GMR-4M

GMR-8M

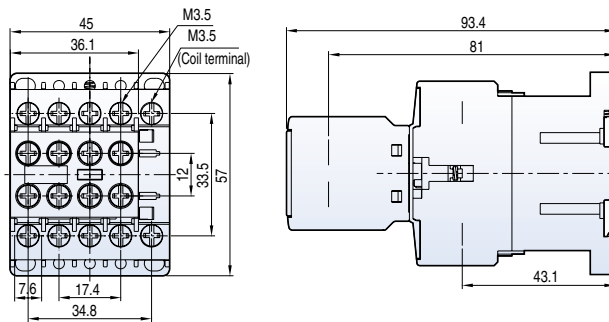

0.21kg

GMR-4M

GMR-8M

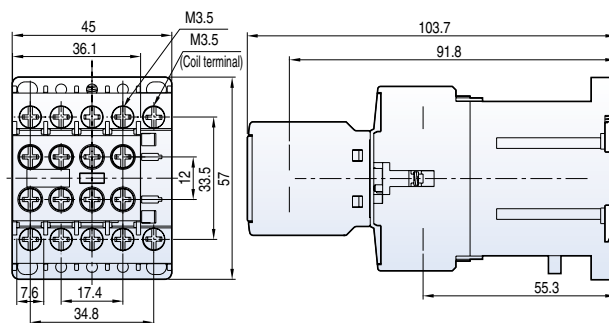

0.21kg

GMR-4M

+

2 × AU-1M

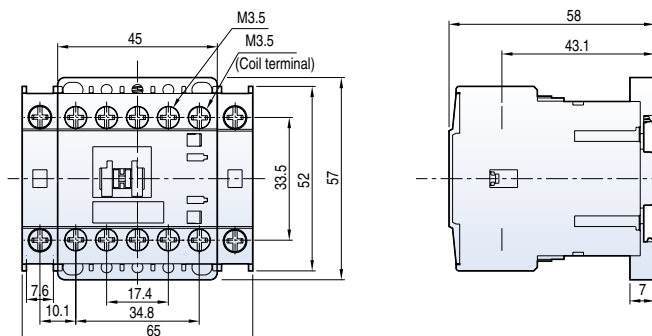

0.21kg

Dimensions

Mini contactor relays

GMR-4MP

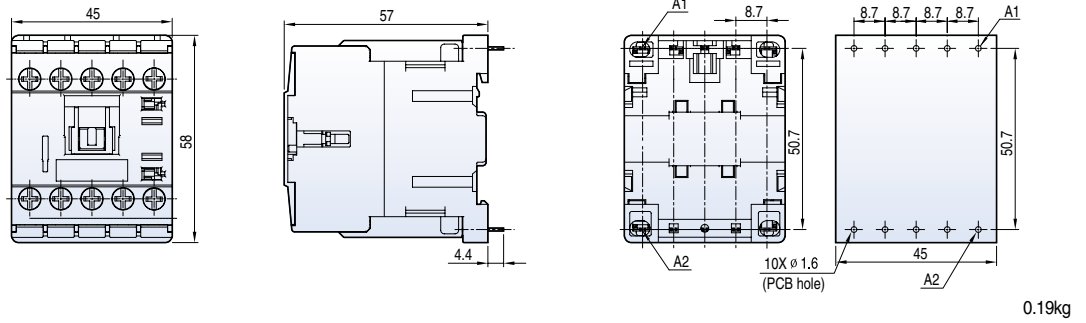

GMR-4MPD

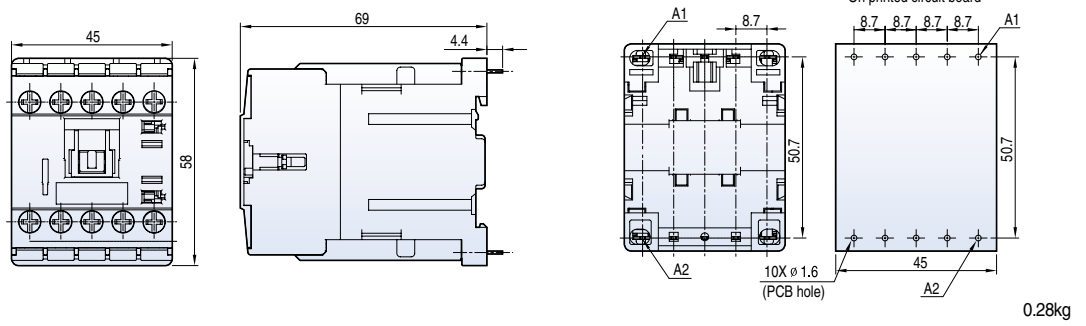

GMR-4MP

+
2 × AU-1M

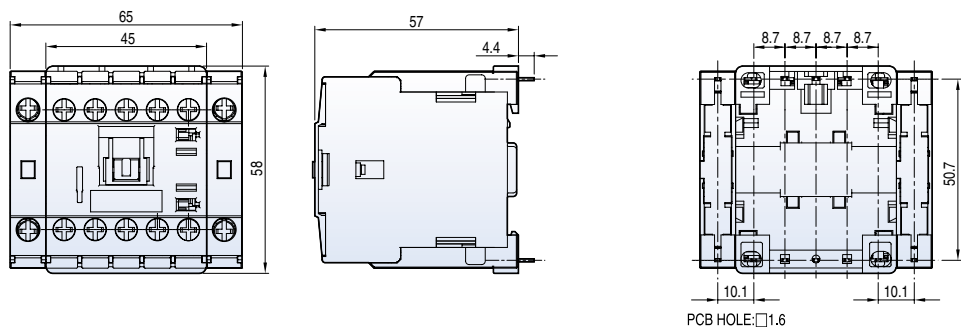

Mini contactor relays

[mm]

GMR-4MF

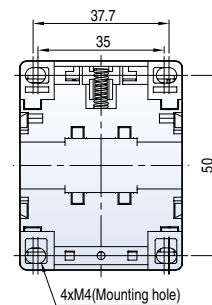
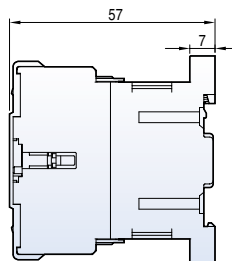
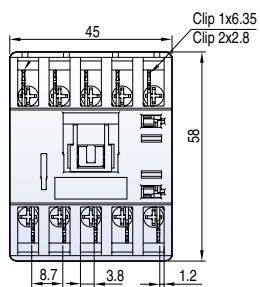

0.18kg

GMR-4MFD

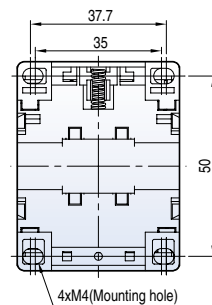
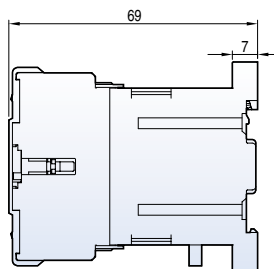
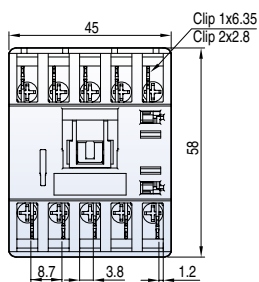

0.27kg

GMR-6MF

GMR-8MF

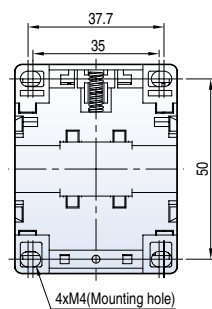
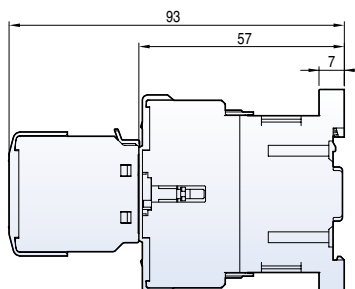
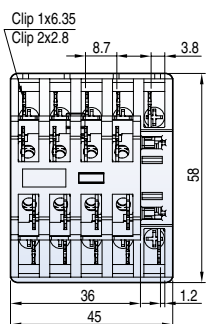

0.23kg

GMR-4MF

+

2 × AU-1MF

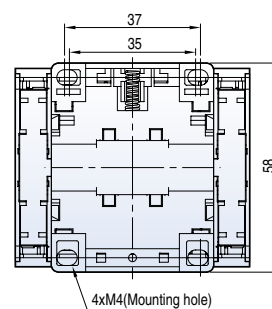
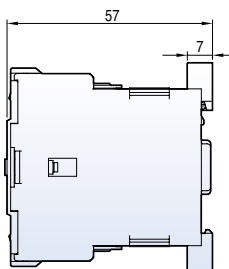
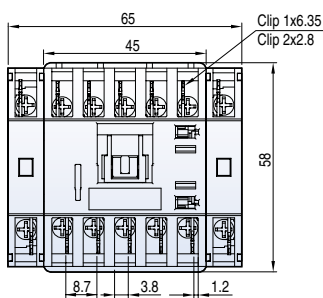

0.32kg

Dimensions

GMR-4MC

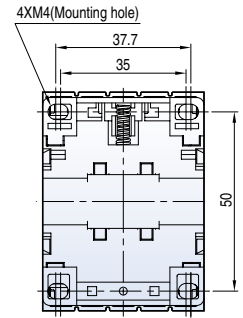
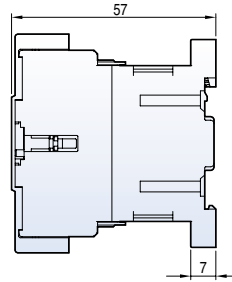
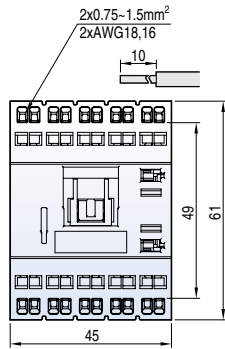

[mm]

0.18kg

GMR-4MCD

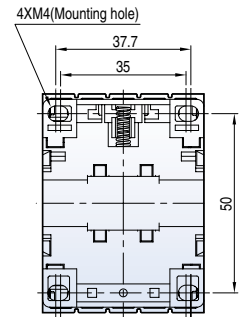
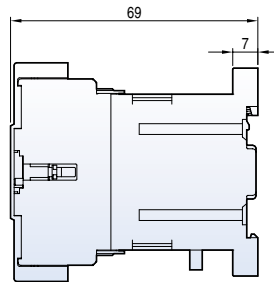
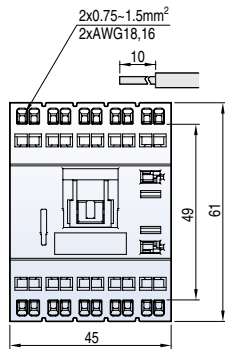

0.27kg

GMR-6MC

GMR-8MC

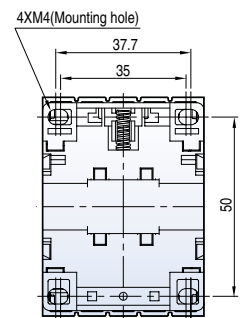
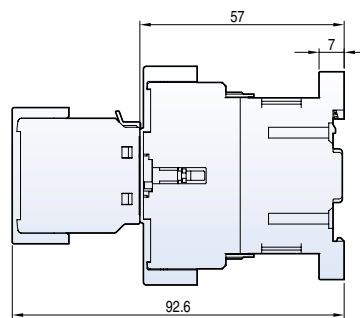
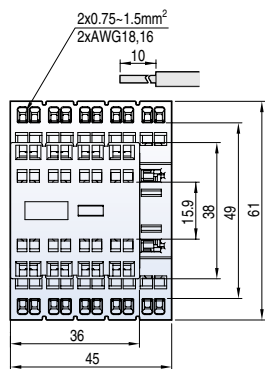

0.23kg

2x

GMR-4MC

+

AU-1MC

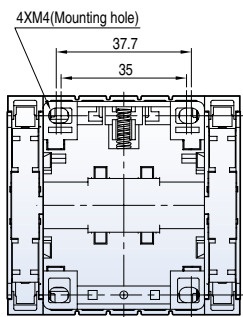
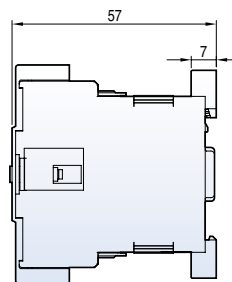
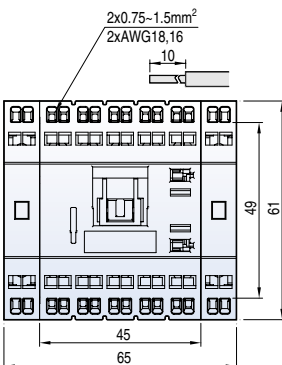

0.32kg

2-pole DC Contactors

SMM-30P

SMM-30DP

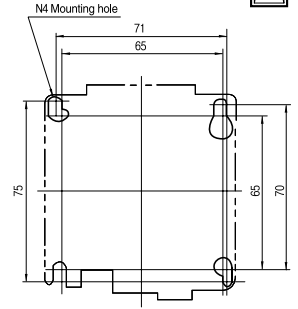
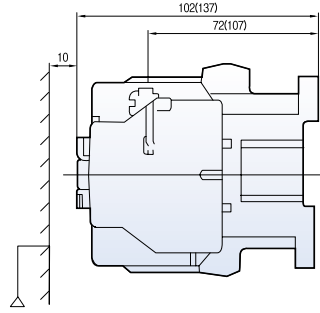
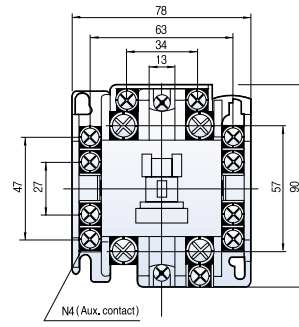

0.61(0.93)kg

SMM-60P

SMM-100P

SMM-60DP

SMM-100DP

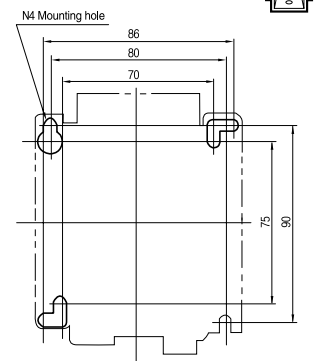
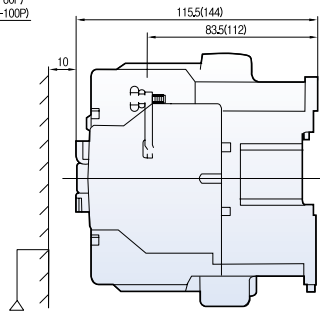
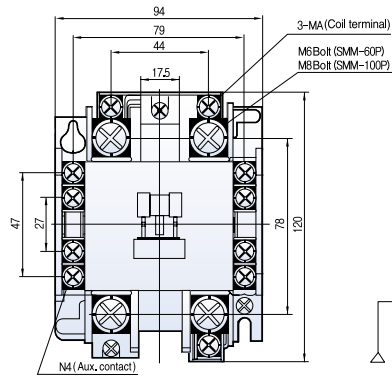

1.15(2.17)kg

[mm]



Dimensions

2-pole AC Contactors

- GMC-10P2
- GMC-20P2
- GMC-25P2
- GMC-30P2
- GMC-35P2
- GMC-40P2
- (TSBS Type)

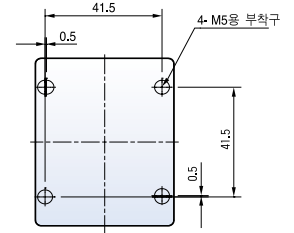
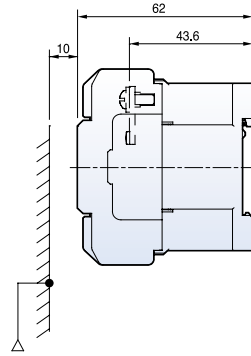
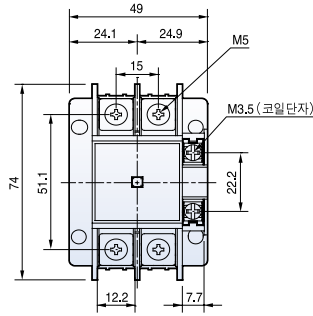

[mm]

1.29kg

- GMC-10P2
- GMC-20P2
- GMC-25P2
- GMC-30P2
- GMC-35P2
- GMC-40P2
- (TQBS Type)

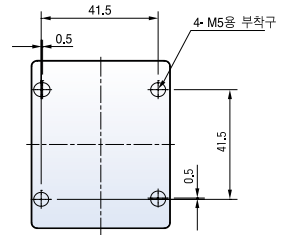
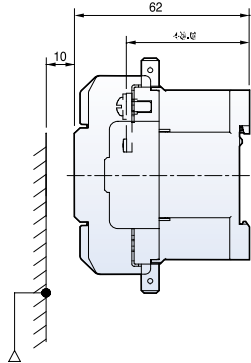
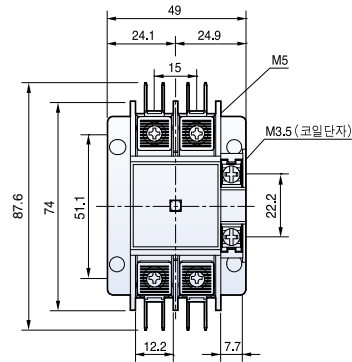

1.29kg

Circuit diagram

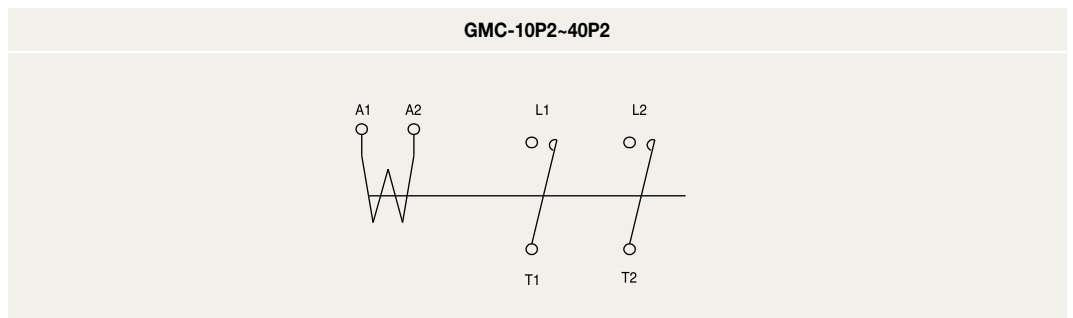

Terminal

Type	Terminal	Screw (mm ²)	Wire (kgf · cm)	Torque (mm)	A × B × C
GMC-10P2-40P2	Main	M5	1-16	26	12.2 × 7 × 8
	Coil	M3.5	1-2.5	12	7.7 × 7.5 × 4.5

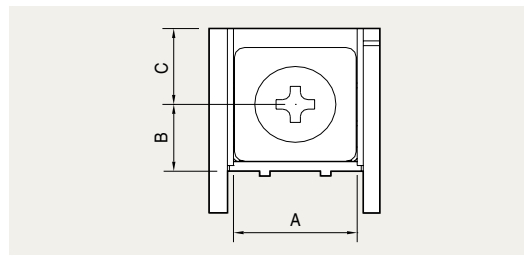

Accessories for Mini contactors

[mm]

AU-4M

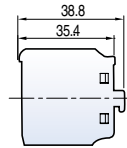
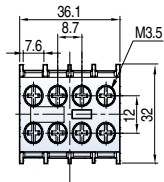

0.04kg

AU-2M

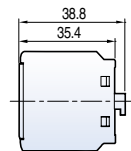
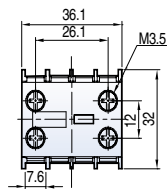

0.03kg

AU-1M

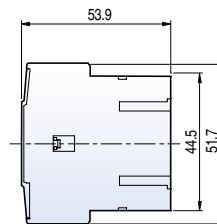
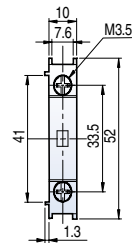

0.02kg

AT-12M

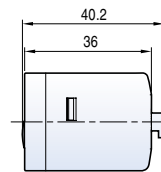
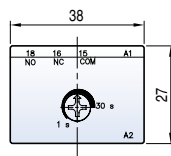

0.04kg

AS-12M

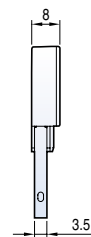
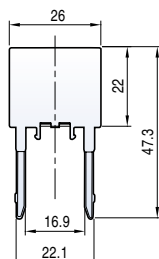

0.005kg



EMPR



Contents :

Electronic overload relays / Digital motor protection relays

Catalog numbering system	142
Specification	
Electronic overload relays	143
Digital motor protection relays	145
Curves	
Trip curves for electronic overload relays	146
Digital motor protection relays	147
Dimensions	
Electronic overload relays	148
Digital motor protection relay	151



Catalog numbering system

Electronic motor protection relay

GMP	22	-	2	P	R	220					
Frame	Current setting value	Type	CT No.		Wiring method		Reverse phase		Operating voltage		
22	0.3~1.5A	Direct/ Screw/ Tunnel	2	2CT	P	Pin type	-	Without reverse phase protection		-	AC100~260V
	1~5A		3	3CT	S	Screw type		R	With reverse phase protection		220
	4.4~22A				T	Tunnel type	110		AC110V		
40	4~20A	Screw									
80	8~40A										
	16~80A										

Frame	Current setting value	Type	Operating voltage	
60	0.5~6A	Tunnel	24	AC 24V
	3~30A		110	AC85~120V
	5~60A		220	AC180~260V
			380	AC380(440V)

Digital motor protection relay (DMP 06-SZ 220)

DMP	-	06	S	Z	a	220			
		Current setting range	Wiring method		Option	Type	Operating voltage		
	06	0.5~6A	S	Screw type	-	Standard	-	220	AC220V
	60	5~60A	T	Tunnel type	Z	Ground fault	a	110	AC110V

- * The standard length of a extension cable is 1.5m, 2m, 4m cable is optional
- * For ground fault protection, ZCT (30 ϕ , 50 ϕ , 65 ϕ , 80 ϕ)made by LS is optionally required
- * Type "a": It has additional functions like as setting operation time by month or by hour, checking & storing operating time

Specification

Electronic overload relays

Ratings



Model		GMP22-2P	GMP22-2P(1a1b) GMP22-3P/3PR		GMP22-2S	GMP22-3S/3SR	GMP22-2T	GMP22-3T/3TR
Type		Pin type			Screw type		Tunnel type	
No. of CT		2CT	2CT	3CT	2CT	3CT	2CT	3CT
Protection	Overcurrent	●	●	●	●	●	●	●
	Phase failure	● Note1)	●	●	●	●	●	●
	Stall	●	●	●	●	●	●	●
	Asymmetry	—	—	●	—	●	—	●
	Reverse phase	—	—	●(3PR)	—	●(3SR)	—	●(3TR)
Current setting range (A)		0.3~1.5 1~5 4.4~22						
Operating time characteristics		Inverse time characteristics(GMP22-2PD: Definite time characteristics)						
Time setting (sec)	Inverse time	0~30 sec						
	Definite D-time	0.2~60 sec for GMP22-2PD						
	O-time	5sec (Fixed) for GMP22-2PD						
Tolerance	Current	±5%						
	Time	±5%(or±0.5sec)						
Control power	Voltage	AC 110V/220V(±10%)	AC 100~260V					
	Frequency	50/60Hz						
Aux. contact	Contact	1SPDT(1c) Note2)	2SPST(When power applied, 1a1b)					
	Ratings	5A/250VAC Resistive load	3A/250VAC Resistive load					
	Operate	(95 ⇄ 96 Close)	(95 ⇄ 96 Close)			(97 ⇄ 98 Open)		
Insulation resistance		Min 100MΩ at 500Vdc						
Surge endurance(IEC 1000-4-5)		1.2 × 50μs 6kV Apply the standard wave						
Fast transient burst(IEC 1000-4-4)		2.5kV/5min.						
Environment Temperature	Operation	-25~70°C						
	Storage	-30~80°C						
	Relative humidity	30~90%RH(No freezing)						
Trip indicator		Red LED	Red/Green LED		Red LED	Red/Green LED	Red LED	Red/Green LED
Dimension(mm)	W × H × D	44 × 71 × 78	53 × 77.5 × 87.5		53 × 68 × 87.5		53 × 38 × 87.5	
Mounting type		Direct mount onto a MC			Separate mount(Screw or Din-rail) Note3)			
Applied MC		GMC-9, GMC-12, GMC-18, GMC-22						
Certification		UL, cUL, CE						

Note) 1. When it is 2CT model, only two-phase protection is available

2. 1a1b Aux. switch is optional in GMP 22-2P model

3. The bracket for Din-rail mount is optional

Specification

Electronic overload relays

Ratings



Model	GMP40-2P	GMP40-3P/3PR	GMP40-2S	GMP40-3S/3SR	GMP40-2T	GMP40-3T/3TR	GMP80-2S	GMP80-3S/3SR
Type	Pin type		Screw type		Tunnel type		Screw type	
No. of CT	2CT	3CT	2CT	3CT	2CT	3CT	2CT	3CT
Protection	Overcurrent	●	●	●	●	●	●	●
	Phase failure	●	●	●	●	●	●	●
	Stall	●	●	●	●	●	●	●
	Asymmetry	—	●	—	●	—	—	●
	Reverse phase	—	●(3PR)	—	●(3SR)	—	●(3TR)	—
Current setting range(A)	4~20						16~80	
	8~40							
Operating time characteristics		Inverse time characteristics						
Time setting (sec)	Inverse time	0~30 sec						
	Reset time	Manual reset (Prompt) Reset after 1 Min.(Optional)						
Tolerance	Current	±5%						
	Time	±5%(or±0.5sec)						
Control power	Voltage	AC 100~260V						
	Frequency	50/60Hz						
Aux. contact	Contact	2SPST(When power applied, 1a1b)						
	Ratings	3A/250VAC Resistive load						
	Operate	(95† 96 Close)			(97† 98 Open)			
Insulation resistance		Min 100MΩ at 500Vdc						
Surge endurance(IEC 1000-4-5)		1.2 × 50μs 6kV Apply the standard wave						
Fast transient burst(IEC 1000-4-4)		2.5kV/5min.						
Environment Temperature	Operation	-25~70°C						
	Storage	-30~80°C						
	Relative humidity	30~90%RH((No freezing)						
Trip indicator	Red LED	Red/Green LED	Red LED	Red/Green LED	Red LED	Red/Green LED	Red LED	2Red LEDs
Dimension(mm)	W × H × D	53 × 77.5 × 87.5		53 × 68 × 87.5		53 × 38 × 87.5		89 × 77.5 × 97.4
Mounting type	Direct mount onto a MC		Separate mount(Screw or Din-rail)				Direct/Separate mount (Screw or Din-rail)	
Applied MC	GMC-32, GMC-40						GMC-50, GMC-65, GMC-75, GMC-85	
Certification	UL, cUL, CE							

Digital motor protection relays



DMP□-S & DMP□-Saa

DMP□-T & DMP□-Ta

Model			DMP06-S/Sa	DMP60-S/Sa	DMP06-T/Ta	DMP60-T/Ta
Wiring			Screw type		Tunnel type	
Panel mount			Unit or Extension Note1)			
Operation time			Select either reverse time characteristics or definite time characteristics			
Protection			According to the setting time			
Over current						
Phase failure			3 sec.			
Reverse phase			Within 0.1 sec.			
Asymmetry			5 sec.			
Stall			5 sec.			
Lock			Within 0.5 sec.			
Under current			3 sec.			
Ground fault			Within 0.05~1 sec. Selectable (0.05~1.0sec)			
Short circuit Note2)			Within 50ms			
Alarm			Variable (60~110% of the setting current)			
Current setting range (A)			0.5~6	5~60	0.5~6	5~60
Motor capacity (kW)			220~240V 0.09~0.75	380~440V 1.1~11	0.09~0.75	1.1~11
Time setting range (sec)			0~60sec			
Definite time			0~30sec			
Inverse time			0~60sec			
Reset			Manual reset			
Tolerance			± 5%			
Current			± 5% (or ± 0.5sec)			
Time			AC 190~250V			
Operating power Note3)			60Hz (50Hz)			
Voltage			3A/250Vac Resistive load			
Frequency			3A/250Vac Resistive load			
Aux. contact OL			2-SPST			
AL			SPST			
Insulation resistance			Over DC500V 100MΩ			
Surge impulse voltage(IEC1000-4-5)			1.2 × 50μs 6kV (Apply standard wave form)			
Fast transient burst(IEC1000-4-4)			2.5kV/5min			
Environment			-25~70°C			
Temperature			-30~80°C			
Operation			30~90% RH (No freezing)			
Storage			7-Segment			
Humidity			3 phase current, cause of a fault			
Display			60~110% of real load current			
Bar-Graph			35mm Din-rail/Panel			
Mounting type						

Note) 1. In extension type, the digital EMPR is calibrated with combining the display part and main body so, please cautious not to combine the display part and main body with different part No.

2. Instantaneous short circuit protection is optional

3. Operational voltage of AC 110V and 50Hz is optional

Electronic overload relays

GMP

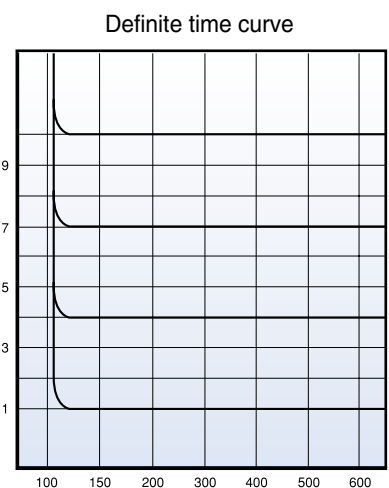
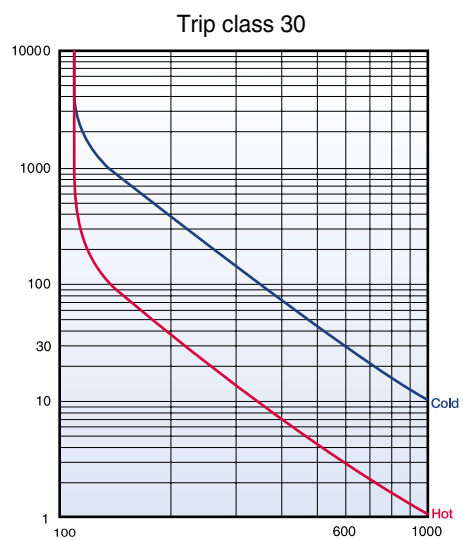
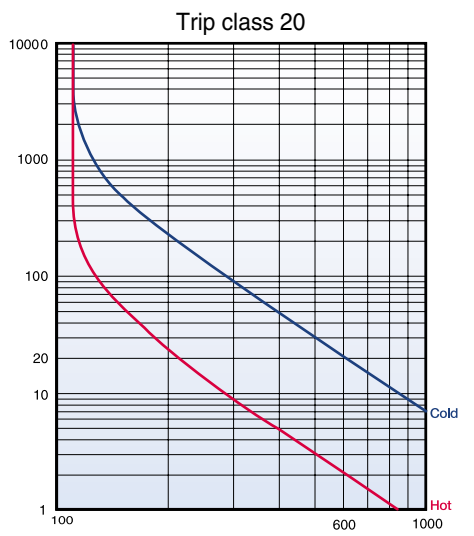
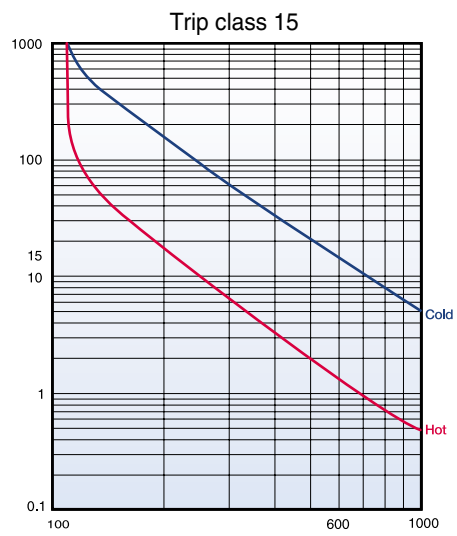
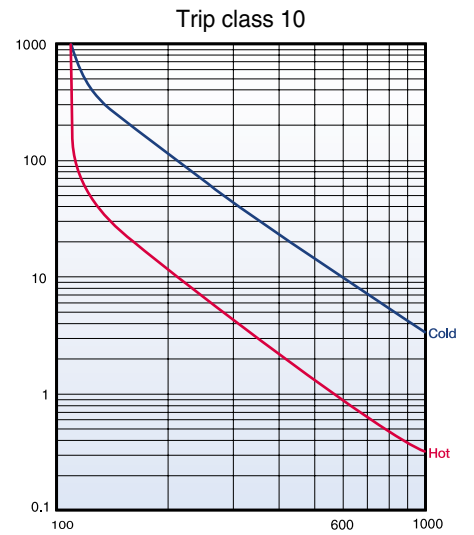
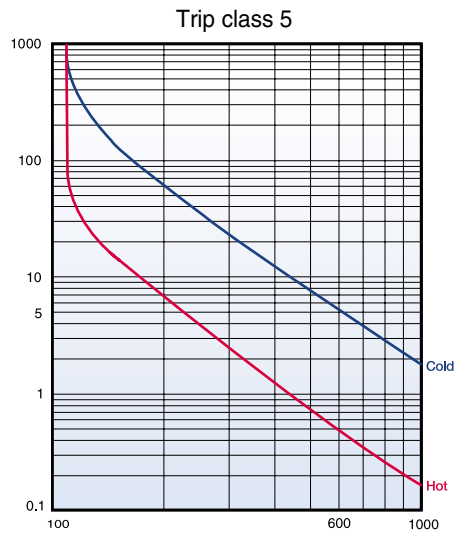

Digital motor protection relays

DMP

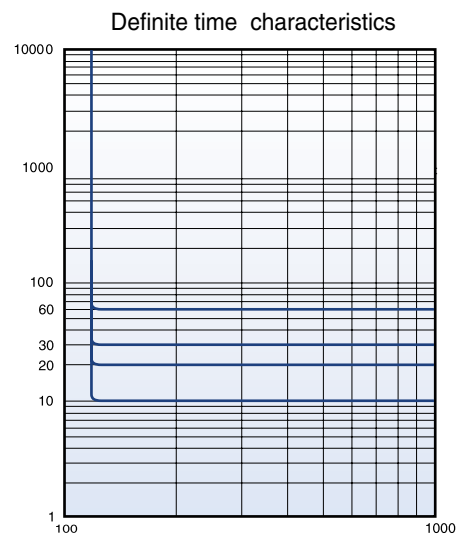
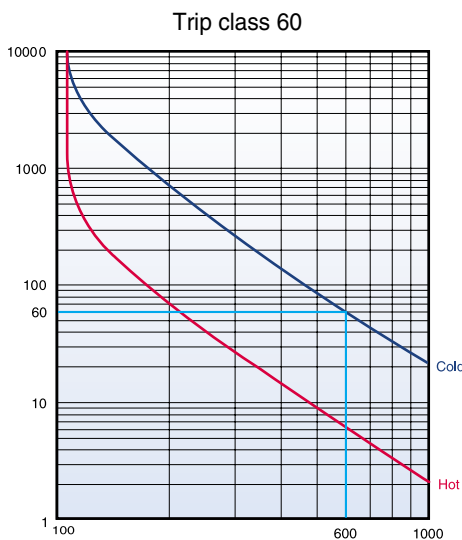
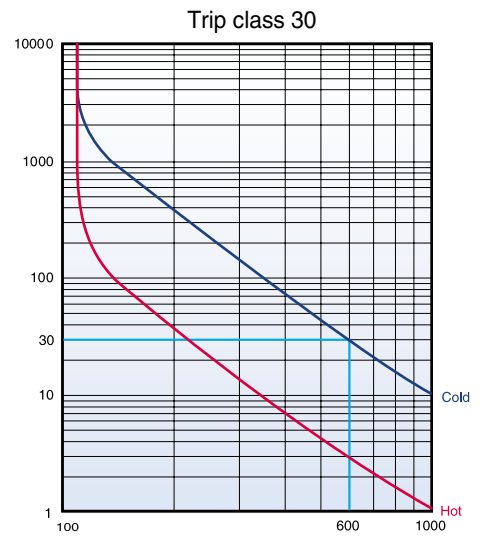
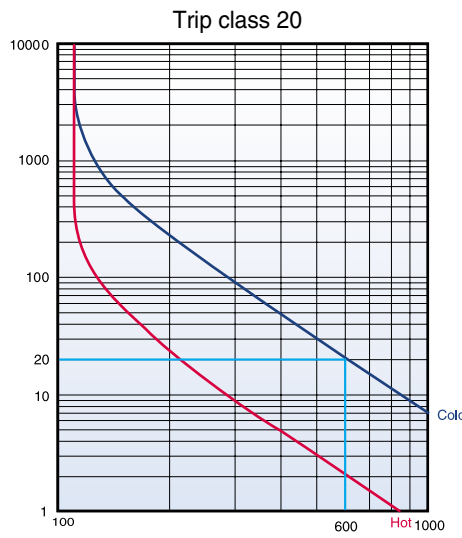
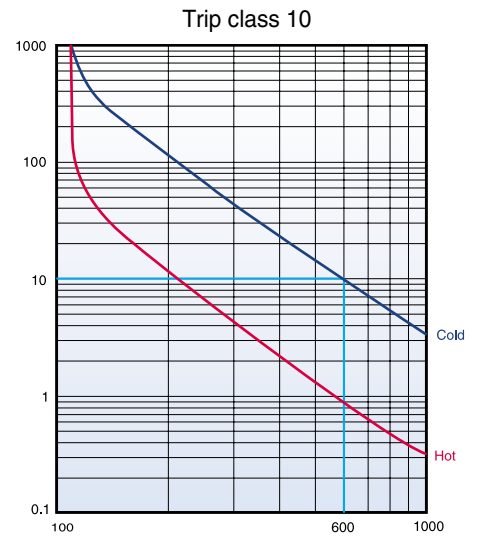
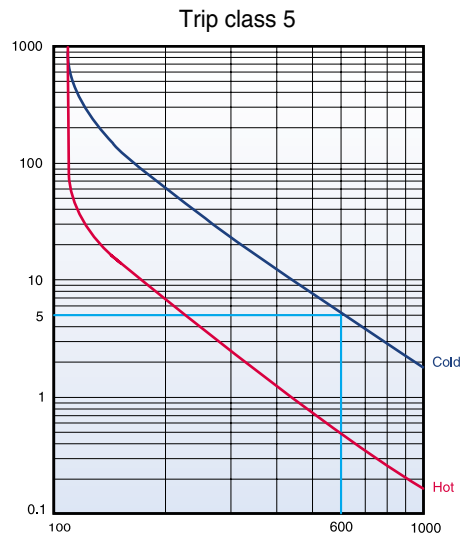

Dimensions

Electronic overload relays

- GMP22-2P
- GMP22-3P
- GMP22-3PR

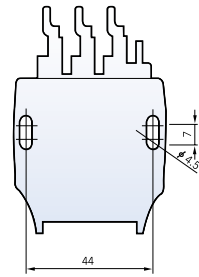
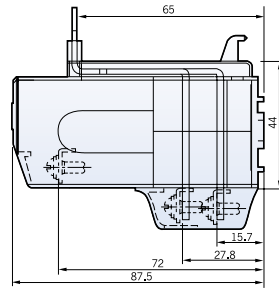
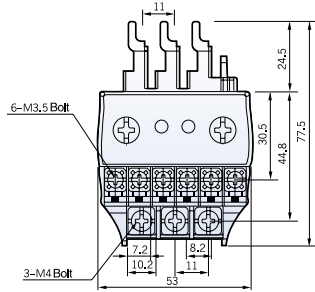

0.18kg

- GMP40-2P
- GMP40-3P
- GMP40-3PR

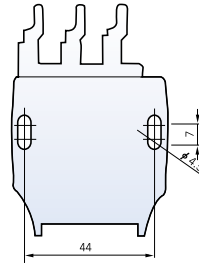
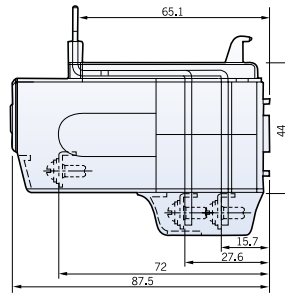
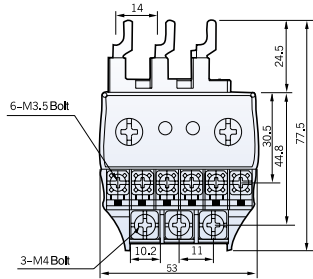

0.20kg/0.22kg

- GMP22-2S
- GMP22-3S
- GMP22-3SR
- GMP40-2S
- GMP40-3S
- GMP40-3SR

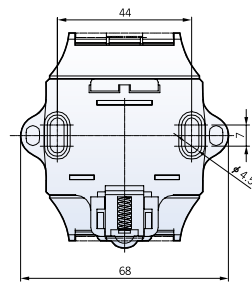
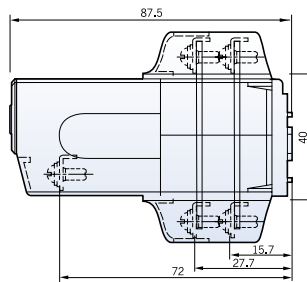
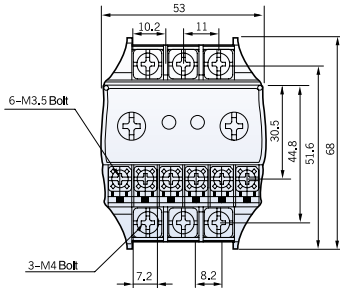

(Mounting adapter)

0.19kg/0.21kg

- GMP22-2T
- GMP22-3T
- GMP22-3TR
- GMP40-2T
- GMP40-3T
- GMP40-3TR

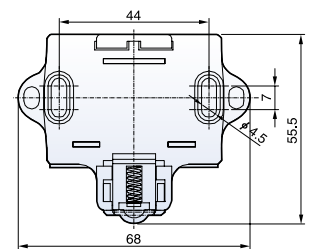
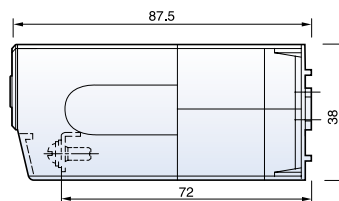
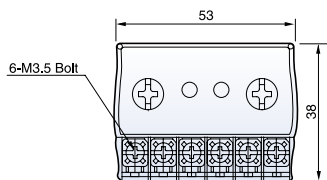

(Mounting adapter)

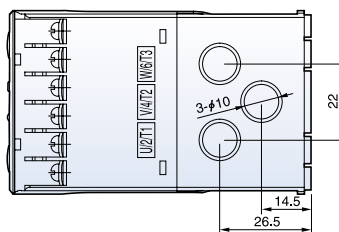

0.14kg/0.16kg

- GMP80-2S
- GMP80-3S
- GMP80-3SR

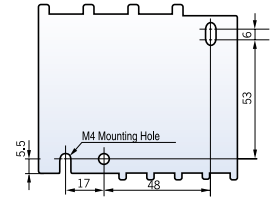
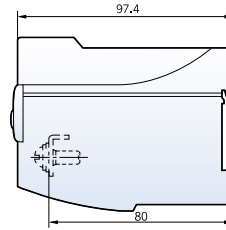
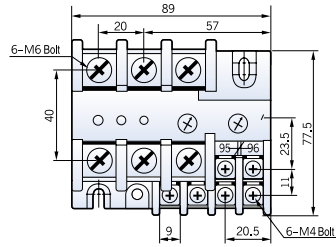

0.42kg/0.46kg

Terminal configuration

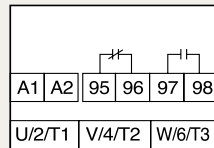

Fig. 1

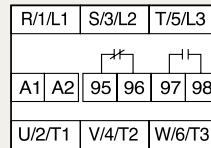

Fig. 2

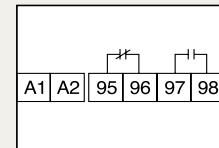
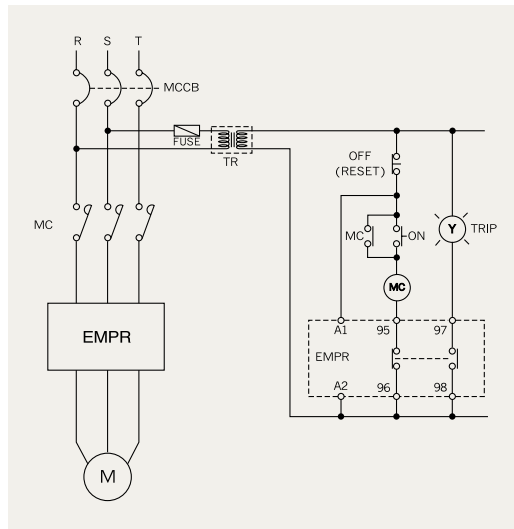
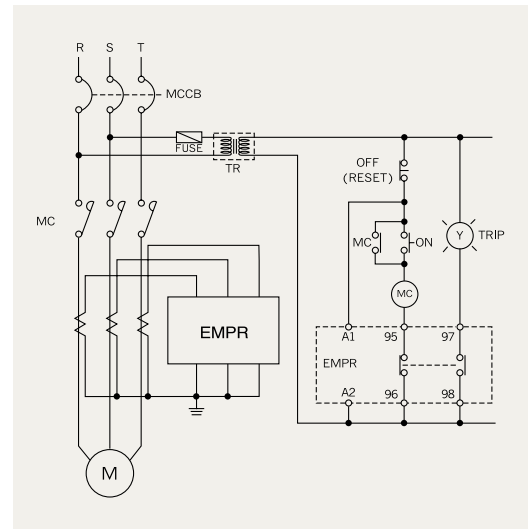

Fig. 3

Circuit diagram



Without additional CTs



In case of using additional CTs

Electronic overload relays

GMP 60T

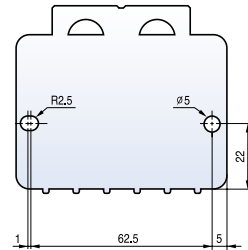
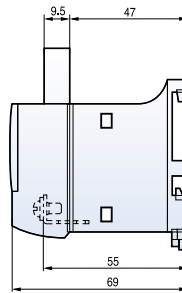
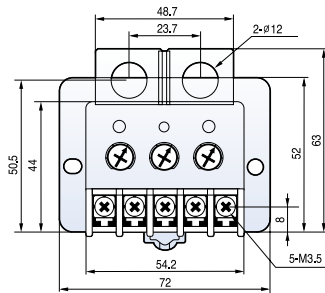

0.42kg/0.46kg

Circuit diagram

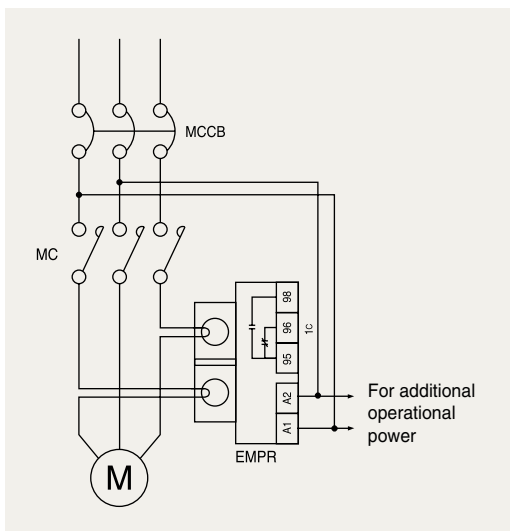

Without additional CTs

Terminal configuration

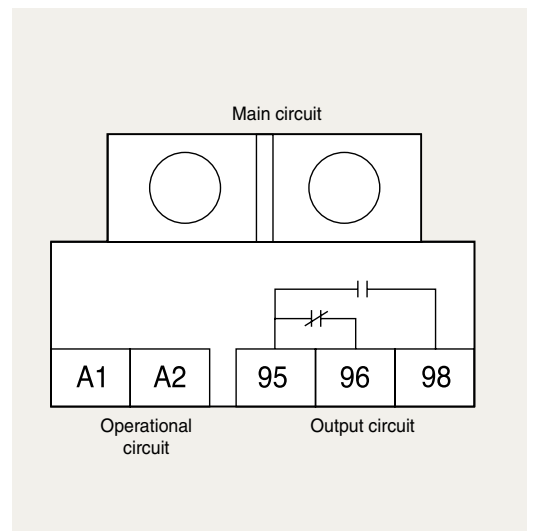

In case of using additional CTs

Digital motor protection relay

- DMP□-T
- DMP□-TZ
- DMP□-Ta
- DMP□-TZa

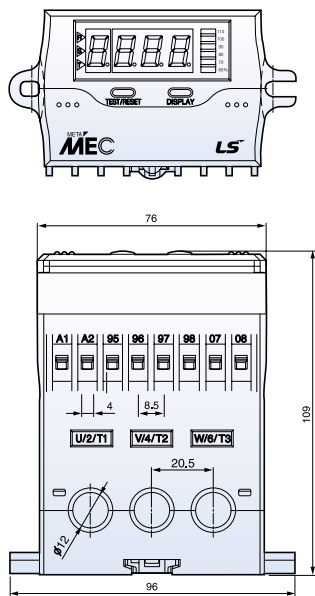

※ Wire size to penetrate a CT :below 22 [mm²]

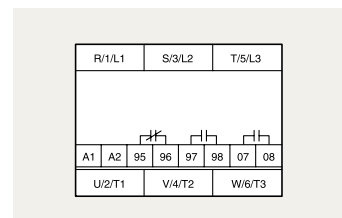
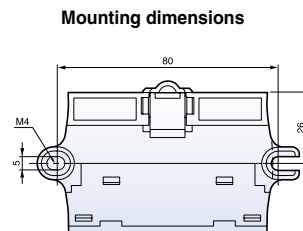

0.56kg

- DMP□-T
- DMP□-TZ
- DMP□-Ta
- DMP□-TZa

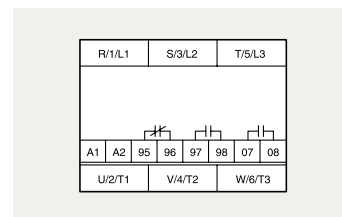
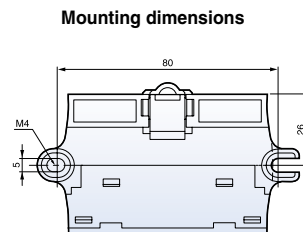
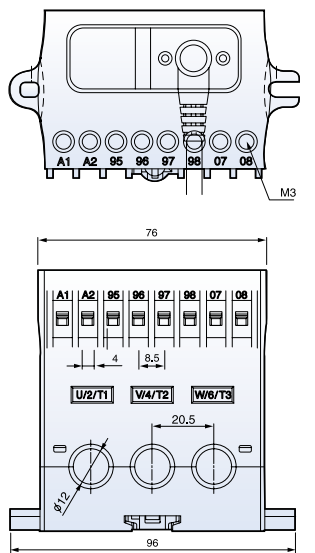

0.5kg

Panel mounting

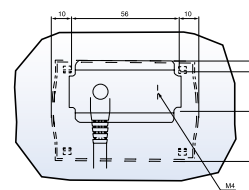
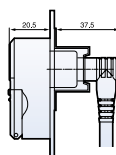
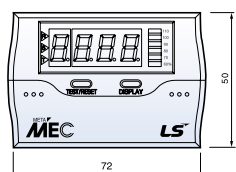

Panel cutting size

Note) 1. In extension type, the digital EMPR is calibrated with combining the display unit and mainbody so, please cautious not to combine the display unit and mainbody with different part No.
 2. The 07-08 contacts are the ZCT input terminal (Digital EMPR with ground fault function)



Manual Motor Starters



Contents :

Manual Motor Starters

Specifications	154
Selection guide	158
Accessories	161
Dimensions	166

LS Meta-MEC Manual Motor Starters provide completed ranges up to 100A



Specifications



Frame		
Type	Current adjustable type	
	Instantaneous type	
Breaking capacity		
Handle Type		
Number of poles		
Rated operational voltage (Ue)		
Rated frequency		
Rated insulation voltage (Ui)		
Rated impulse voltage (Uimp)		
Utilization category	IEC 60 947-2 (Breaker)	
	IEC 60 947-4 (Motor starter)	
Mechanical endurance (Operating)		
Electrical endurance (Cycles)		
Max operating frequency per hour (Ope./h)		
Temperature compensation (Operation)		
Instantaneous short circuit release		
Overload protection		
Phase failure function		
Trip indicating function		
Test function		
Weight (kg)		
Rated breaking capacity (kA)	Rated operational current (Ie)	Thermal release Adjustment range (A)
	0.16	0.1~0.16
	0.25	0.16~0.25
	0.4	0.25~0.4
	0.63	0.4~0.63
	1	0.63~1
	1.6	1~1.6
	2.5	1.6~2.5
	4	2.5~4
	6	4~6
	8	5~8
	10	6~10
	13	9~13
17	11~17	
22	14~22	
26	18~26	
32	22~32	
40	28~40	
50	34~50	
63	45~63	
65	47~65	
75	55~75	
90	70~90	
100	80~100	

32AF																			
MMS-32S										MMS-32H									
Standard Toggle										High breaking Rotary									
MMS-32S										MMS-32HI									
Up to 690V										Up to 690V									
50/60 Hz										50/60 Hz									
690V										690V									
6kV										6kV									
Cat. A										Cat. A									
AC 3										AC 3									
100,000										100,000									
100,000										100,000									
25										25									
-20 ~ +60 °C										-20 ~ +60 °C									
13 × Ie max.										13 × Ie max.									
○										○									
○										○									
×										×									
○										○									
0.32										0.36									
220V 240V 230V	415V 400V	460V 440V	525V 500V	690V 600V	220V 240V 230V	415V 400V	460V 440V	525V 500V	690V 600V	220V 240V 230V	415V 400V	460V 440V	525V 500V	690V 600V	220V 240V 230V	415V 400V	460V 440V	525V 500V	690V 600V
Icu Ics	Icu Ics	Icu Ics	Icu Ics	Icu Ics	Icu Ics	Icu Ics	Icu Ics	Icu Ics	Icu Ics	Icu Ics	Icu Ics	Icu Ics	Icu Ics	Icu Ics	Icu Ics	Icu Ics	Icu Ics	Icu Ics	Icu Ics
100 100	100 100	100 100	100 100	100 100	100 100	100 100	100 100	100 100	100 100	100 100	100 100	100 100	100 100	100 100	100 100	100 100	100 100	100 100	100 100
100 100	100 100	100 100	100 100	100 100	100 100	100 100	100 100	100 100	100 100	100 100	100 100	100 100	100 100	100 100	100 100	100 100	100 100	100 100	100 100
100 100	100 100	100 100	100 100	100 100	100 100	100 100	100 100	100 100	100 100	100 100	100 100	100 100	100 100	100 100	100 100	100 100	100 100	100 100	100 100
100 100	100 100	100 100	100 100	100 100	100 100	100 100	100 100	100 100	100 100	100 100	100 100	100 100	100 100	100 100	100 100	100 100	100 100	100 100	100 100
100 100	100 100	100 100	100 100	100 100	100 100	100 100	100 100	100 3 3	100 3 3	100 100	100 100	100 100	100 100	100 100	100 100	100 100	100 100	100 100	100 100
100 100	100 100	100 100	100 100	100 50 38	100 50 38	100 50 38	100 50 38	100 3 3	100 3 3	100 100	100 100	100 100	100 100	100 100	100 100	100 100	100 100	100 8 8	100 8 8
100 100	100 100	100 100	100 50 38	100 15 11	100 15 11	100 15 11	100 8 3	100 3 3	100 3 3	100 100	100 100	100 100	100 100	100 100	100 100	100 100	100 100	100 6 6	100 6 6
100 100	100 100	100 100	100 15 11	100 11 10	100 11 10	100 11 10	100 8 3	100 3 3	100 3 3	100 100	100 100	100 100	100 50 38	100 50 38	100 50 38	100 50 38	100 6 6	100 6 6	100 6 6
100 100	100 50 38	100 15 11	100 11 6	100 5 3	100 5 3	100 5 3	100 3 3	100 3 3	100 3 3	100 100	100 100	100 100	100 50 38	100 50 38	100 50 38	100 42 32	100 6 6	100 6 6	100 6 6
100 100	50 38	20 15 10	8 6 5	3 3	3 3	3 3	3 3	3 3	3 3	100 100	100 50 38	20 15 10	8 4 4	8 4 4	8 4 4	8 4 4	8 4 4	8 4 4	8 4 4
40 30	15 11	8 6 6	5 3 3	3 3	3 3	3 3	3 3	3 3	3 3	100 100	50 38	20 15 10	8 4 4	8 4 4	8 4 4	8 4 4	8 4 4	8 4 4	8 4 4
40 30	15 11	8 6 5	4 3 3	3 3	3 3	3 3	3 3	3 3	3 3	100 100	50 38	20 15 10	8 4 4	8 4 4	8 4 4	8 4 4	8 4 4	8 4 4	8 4 4
30 22	15 11	6 4 5	4 3 3	3 3	3 3	3 3	3 3	3 3	3 3	100 100	50 38	20 15 10	8 4 4	8 4 4	8 4 4	8 4 4	8 4 4	8 4 4	8 4 4
20 15	10 8	5 3 4	3 2 2	2 2	2 2	2 2	2 2	2 2	2 2	100 100	40 30	15 11	8 6 3	8 6 3	8 6 3	8 6 3	8 6 3	8 6 3	8 6 3
-	-	-	-	-	-	-	-	-	-	-	-	-	-	-	-	-	-	-	-
-	-	-	-	-	-	-	-	-	-	-	-	-	-	-	-	-	-	-	-
-	-	-	-	-	-	-	-	-	-	-	-	-	-	-	-	-	-	-	-
-	-	-	-	-	-	-	-	-	-	-	-	-	-	-	-	-	-	-	-
-	-	-	-	-	-	-	-	-	-	-	-	-	-	-	-	-	-	-	-
-	-	-	-	-	-	-	-	-	-	-	-	-	-	-	-	-	-	-	-



63AF										100AF										
MMS-63S					MMS-63H					MMS-100S					MMS-100H					
-					MMS-63HI					-					MMS-100HI					
Standard					High breaking					Standard					High breaking					
Rotary					Rotary					Rotary					Rotary					
3					3					3					3					
Up to 690V					Up to 690V					Up to 690V					Up to 690V					
50/60 Hz					50/60 Hz					50/60 Hz					50/60 Hz					
1,000V					1,000V					1,000V					1,000V					
8kV					8kV					8kV					8kV					
Cat. A					Cat. A					Cat. A					Cat. A					
AC 3					AC 3					AC 3					AC 3					
50,000					50,000					50,000					50,000					
25,000					25,000					25,000					25,000					
25					25					25					25					
-20 ~ +60°C					-20 ~ +60°C					-20 ~ +60°C					-20 ~ +60°C					
13 × I _e max.					13 × I _e max.					13 × I _e max.					13 × I _e max.					
○					○					○					○					
○					○					○					○					
×					×					○					○					
○					○					○					○					
10										22										
220V 240V 230V	415V 400V	460V 440V	525V 500V	690V 600V	220V 240V 230V	415V 400V	460V 440V	525V 500V	690V 600V	220V 240V 230V	415V 400V	460V 440V	525V 500V	690V 600V	220V 240V 230V	415V 400V	460V 440V	525V 500V	690V 600V	
I _{cu}	I _{cs}	I _{cu}	I _{cs}	I _{cu}	I _{cs}	I _{cu}	I _{cs}	I _{cu}	I _{cs}	I _{cu}	I _{cs}	I _{cu}	I _{cs}	I _{cu}	I _{cs}	I _{cu}	I _{cs}	I _{cu}	I _{cs}	
-	-	-	-	-	-	-	-	-	-	-	-	-	-	-	-	-	-	-	-	-
-	-	-	-	-	-	-	-	-	-	-	-	-	-	-	-	-	-	-	-	-
-	-	-	-	-	-	-	-	-	-	-	-	-	-	-	-	-	-	-	-	-
-	-	-	-	-	-	-	-	-	-	-	-	-	-	-	-	-	-	-	-	-
-	-	-	-	-	-	-	-	-	-	-	-	-	-	-	-	-	-	-	-	-
-	-	-	-	-	-	-	-	-	-	-	-	-	-	-	-	-	-	-	-	-
-	-	-	-	-	-	-	-	-	-	-	-	-	-	-	-	-	-	-	-	-
-	-	-	-	-	-	-	-	-	-	-	-	-	-	-	-	-	-	-	-	-
-	-	-	-	-	-	-	-	-	-	-	-	-	-	-	-	-	-	-	-	-
-	-	-	-	-	-	-	-	-	-	-	-	-	-	-	-	-	-	-	-	-
-	-	-	-	-	-	-	-	-	-	-	-	-	-	-	-	-	-	-	-	-
100	100	100	15	12	10	8	4	3	100	100	100	50	38	50	38	6	5	-	-	-
100	100	50	38	10	8	6	5	4	3	100	100	100	50	38	42	32	6	5	-	-
100	100	25	19	10	8	6	5	4	3	100	100	50	50	38	12	9	5	5	100	100
50	38	25	19	10	8	6	5	4	3	100	100	50	50	38	12	9	5	5	100	100
50	38	25	19	10	8	6	5	4	3	100	100	50	50	35	27	12	9	5	5	100
50	38	25	19	10	8	6	5	4	3	100	100	50	50	35	27	10	8	5	5	100
50	38	25	19	10	8	6	5	4	3	100	100	50	50	35	27	10	8	5	5	100
50	38	25	19	10	8	6	5	4	3	100	100	50	50	35	27	10	8	5	5	100
50	38	25	19	10	8	6	5	4	3	100	100	50	50	35	27	10	8	5	5	100
-	-	-	-	-	-	-	-	-	-	-	-	-	-	-	-	-	-	-	-	-
-	-	-	-	-	-	-	-	-	-	-	-	-	-	-	-	-	-	-	-	-
-	-	-	-	-	-	-	-	-	-	-	-	-	-	-	-	-	-	-	-	-
-	-	-	-	-	-	-	-	-	-	-	-	-	-	-	-	-	-	-	-	-
100	100	75	50	50	38	12	9	6	6	100	100	75	50	50	38	12	9	6	6	100
100	100	75	50	50	38	12	9	6	6	100	100	75	50	50	38	12	9	6	6	100
100	100	75	50	50	38	12	9	6	6	100	100	75	50	50	38	12	9	6	6	100
100	100	75	50	50	38	12	9	6	6	100	100	75	50	50	38	12	9	6	6	100

Selection guide

Standard type

- Adjustable thermal release
- Magnetic release 13 I_e max.
- Trip class 10
- Ambient temperature compensation
- Protective function
 - phase-failure
 - short circuit
 - overload

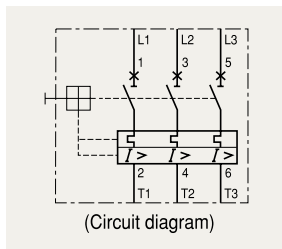

MMS-32S

MMS-63S

MMS-100S

Type	Rated operational current I _e [A]	Thermal release adjustment range [A]	Magnetic release operating current [A]	Switching of 3 phase AC motors, AC-2, AC-3						400/415V	
				3-phase [kW] (50/60Hz)			3-phase [HP] (60Hz)			I _{cu} [kA]	I _{cs} [kA]
				230V	400V	690V	230V	460V	575V		
MMS-32S	0.16	0.1...0.16	2.1	-	0.02	-	-	-	-	100	100
	0.25	0.16...0.25	3.3	0.03	0.06	-	-	-	-	100	100
	0.4	0.25...0.4	5.2	0.06	0.09	-	-	-	-	100	100
	0.63	0.4...0.63	8.2	0.09	0.12	0.25	-	-	-	100	100
	1	0.63...1.0	13	0.12	0.25	0.55	-	1/2	1/2	100	100
	1.6	1.0...1.6	20.8	0.25	0.55	1.1	1/3	3/4	1	100	100
	2.5	1.6...2.5	32.5	0.37	0.75	1.5	1/2	1 1/2	1 1/2	100	100
	4	2.5...4.0	52	0.75	1.5	3	1	2	3	100	100
	6	4...6	78	1.5	2.2	4	1 1/2	5	5	100	100
	8	5...8	104	1.5	3	5.5	2	5	5	100	100
	10	6...10	130	3	4	7.5	3	7 1/2	10	50	38
	13	9...13	169	3	5.5	11	3	7 1/2	10	50	38
	17	11...17	221	4	7.5	11	5	10	15	20	15
	22	14...22	286	4	7.5	15	7 1/2	15	20	15	11
MMS-63S	26	18...26	338	5.5	11	18.5	7 1/2	15	20	15	11
	32	22...32	416	7.5	15	22	10	20	30	15	11
	40	28~40	520	7.5	18.5	30	15	30	40	10	8
	10	6~10	130	3	4	7.5	3	7 1/2	10	100	100
	13	9~13	169	3	5.5	11	3	7 1/2	10	50	38
	17	11~17	221	4	7.5	11	5	10	15	25	19
	22	14~22	286	4	7.5	15	7 1/2	15	20	25	19
	26	18~26	338	5.5	11	18.5	10	20	25	25	19
	32	22~32	416	7.5	15	22	10	25	30	25	19
MMS-100S	40	28~40	520	7.5	18.5	30	15	30	40	25	19
	50	34~50	650	11	22	45	15	40	50	25	19
	63	45~63	819	15	30	55	20	50	60	25	19
	65	47~65	845	15	30	55	20	50	60	25	19
	17	11~17	221	4	7.5	11	5	10	15	50	38
	22	14~22	286	4	7.5	15	7 1/2	15	20	50	38
	26	18~26	338	5.5	11	18.5	10	20	25	50	38
	32	22~32	416	7.5	15	22	10	25	30	50	38
	40	28~40	520	7.5	18.5	30	15	30	40	50	38
	50	34~50	650	11	22	45	15	40	50	50	38
63	45~63	819	15	30	55	20	50	60	50	38	
75	55~75	975	22	37	63	25	60	75	50	38	
90	70~90	1170	30	45	75	30	75	100	50	38	
100	80~100	1300	30	45	90	40	75	100	50	38	

High breaking type

- Adjustable thermal release
- Magnetic release 13 I_e max.
- Trip class 10
- Ambient temperature compensation
- Protective function
 - phase-failure
 - short circuit
 - overload

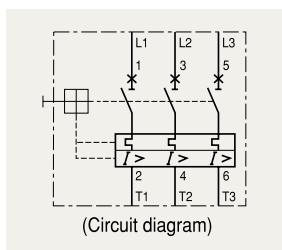

Type	Rated operational current I _e [A]	Thermal release adjustment range [A]	Magnetic release operating current [A]	Switching of 3 phase AC motors, AC-2, AC-3						400/415V	
				3-phase [kW] (50/60Hz)			3-phase [HP] (60Hz)			I _{cu} [kA]	I _{cs} [kA]
				230V	400V	690V	230V	460V	575V		
MMS-32H	0.16	0.1...0.16	2.1	-	0.02	-	-	-	-	100	100
	0.25	0.16...0.25	3.3	0.03	0.06	-	-	-	-	100	100
	0.4	0.25...0.4	5.2	0.06	0.09	-	-	-	-	100	100
	0.63	0.4...0.63	8.2	0.09	0.12	0.25	-	-	-	100	100
	1	0.63...1.0	13	0.12	0.25	0.55	-	1/2	1/2	100	100
	1.6	1.0...1.6	20.8	0.25	0.55	1.1	1/3	3/4	1	100	100
	2.5	1.6...2.5	32.5	0.37	0.75	1.5	1/2	1 1/2	1 1/2	100	100
	4	2.5...4.0	52	0.75	1.5	3	1	2	3	100	100
	6	4...6	78	1.5	2.2	4	1 1/2	5	5	100	100
	8	5...8	104	1.5	3	5.5	2	5	5	100	100
	10	6...10	130	3	4	7.5	3	7 1/2	10	100	100
	13	9...13	169	3	5.5	11	3	7 1/2	10	100	100
	17	11...17	221	4	7.5	11	5	10	15	50	38
	22	14...22	286	4	7.5	15	7 1/2	15	20	50	38
MMS-63H	26	18...26	338	5.5	11	18.5	7 1/2	15	20	50	38
	32	22...32	416	7.5	15	22	10	20	30	50	38
	40	28~40	520	7.5	18.5	30	15	30	40	40	30
	10	6~10	130	3	4	7.5	3	7 1/2	10	100	100
	13	9~13	169	3	5.5	11	3	7 1/2	10	100	100
	17	11~17	221	4	7.5	11	5	10	15	50	50
	22	14~22	286	4	7.5	15	7 1/2	15	20	50	50
	26	18~26	338	5.5	11	18.5	10	20	25	50	50
	32	22~32	416	7.5	15	22	10	25	30	50	50
	40	28~40	520	7.5	18.5	30	15	30	40	50	50
MMS-100H	50	34~50	650	11	22	45	15	40	50	50	50
	63	45~63	819	15	30	55	20	50	60	50	50
	65	47~65	845	15	30	55	20	50	60	35	27
	17	11~17	221	4	7.5	11	5	10	15	100	100
	22	14~22	286	4	7.5	15	7 1/2	15	20	100	50
	26	18~26	338	5.5	11	18.5	10	20	25	100	50
	32	22~32	416	7.5	15	22	10	25	30	100	50
	40	28~40	520	7.5	18.5	30	15	30	40	100	50
	50	34~50	650	11	22	45	15	40	50	100	50
	63	45~63	819	15	30	55	20	50	60	100	50
75	55~75	975	22	37	63	25	60	75	75	50	
90	70~90	1170	30	45	75	30	75	100	75	50	
100	80~100	1300	30	45	90	40	75	100	75	50	

Selection guide





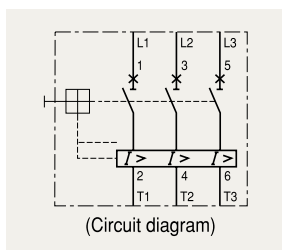

Instantaneous type

- Without thermal releases
- Magnetic release 13 I_e max.
- Protective function
 - short circuit

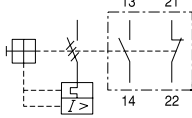
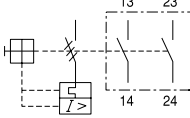
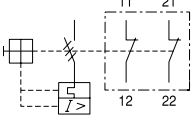

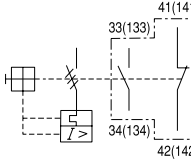
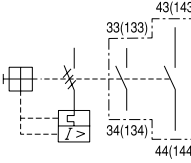
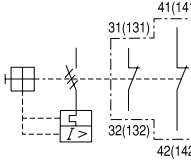

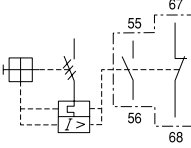
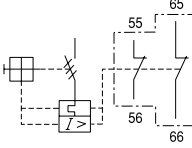

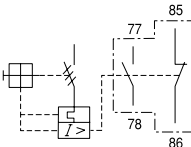
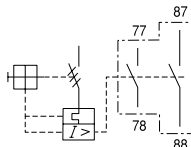
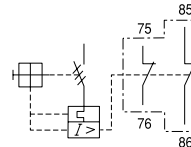
Type	Rated operational current I _e [A]	Thermal release adjustment range [A]	Magnetic release operating current [A]	Switching of 3 phase AC motors, AC-2, AC-3						400/415V	
				3-phase [kW] (50/60Hz)			3-phase [HP] (60Hz)			I _{cu} [kA]	I _{cs} [kA]
				230V	400V	690V	230V	460V	575V		
MMS-32HI	0.16	-	2.1	-	0.02	-	-	-	-	100	100
	0.25	-	3.3	0.03	0.06	-	-	-	-	100	100
	0.4	-	5.2	0.06	0.09	-	-	-	-	100	100
	0.63	-	8.2	0.09	0.12	0.25	-	-	-	100	100
	1	-	13	0.12	0.25	0.55	-	1/2	1/2	100	100
	1.6	-	20.8	0.25	0.55	1.1	1/3	3/4	1	100	100
	2.5	-	32.5	0.37	0.75	1.5	1/2	1½	1½	100	100
	4	-	52	0.75	1.5	3	1	2	3	100	100
	6	-	78	1.5	2.2	4	1½	5	5	100	100
	8	-	104	1.5	3	5.5	2	5	5	100	100
	10	-	130	3	4	7.5	3	7½	10	100	100
	13	-	169	3	5.5	11	3	7½	10	100	100
	17	-	221	4	7.5	11	5	10	15	50	38
	22	-	286	4	7.5	15	7½	15	20	50	38
26	-	338	5.5	11	18.5	7½	15	20	50	38	
32	-	416	7.5	15	22	10	20	30	50	38	
40	-	28~40	7.5	18.5	30	15	30	40	40	30	
MMS-63HI	10	-	130	3	4	7.5	3	7½	10	100	100
	13	-	169	3	5.5	11	3	7½	10	100	100
	17	-	221	4	7.5	11	5	10	15	50	50
	22	-	286	4	7.5	15	7½	15	20	50	50
	26	-	338	5.5	11	18.5	10	20	25	50	50
	32	-	416	7.5	15	22	10	25	30	50	50
	40	-	520	7.5	18.5	30	15	30	40	50	50
	50	-	650	11	22	45	15	40	50	50	50
	63	-	819	15	30	55	20	50	60	50	50
65	-	47~65	15	30	55	20	50	60	35	27	
MMS-100HI	17	-	221	4	7.5	11	5	10	15	100	100
	22	-	286	4	7.5	15	7½	15	20	100	50
	26	-	338	5.5	11	18.5	10	20	25	100	50
	32	-	416	7.5	15	22	10	25	30	100	50
	40	-	520	7.5	18.5	30	15	30	40	100	50
	50	-	650	11	22	45	15	40	50	100	50
	63	-	819	15	30	55	20	50	60	100	50
	75	-	975	22	37	63	25	60	75	75	50
	90	-	1170	30	45	75	30	75	100	75	50
	100	-	1300	30	45	90	40	75	100	75	50

Auxiliaries

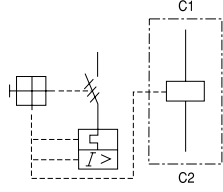
Type	Description	Connection diagram
FX... 	Auxiliary Switch <ul style="list-style-type: none"> • Front mounting • 2-pole • One front mounting module per circuit breaker 	<div style="display: flex; justify-content: space-around;"> <div style="text-align: center;"> 1NO1NC  </div> <div style="text-align: center;"> 2NO  </div> <div style="text-align: center;"> 2NC  </div> </div>
LX... 	Auxiliary Switch <ul style="list-style-type: none"> • Side mounting on the left • 2-pole • One side mounting module per circuit breaker 	<div style="display: flex; justify-content: space-around;"> <div style="text-align: center;"> 1NO1NC  </div> <div style="text-align: center;"> 2NO  </div> <div style="text-align: center;"> 2NC  </div> </div>
LA... 	Any Trip Alarm Switch <ul style="list-style-type: none"> • Operates in case of trip • Side mounting on the left • 2-pole • Set LA first in case of using LX together (MMS-63 can not accept LX and LA together) 	<div style="display: flex; justify-content: space-around;"> <div style="text-align: center;"> 1NO1NC  </div> <div style="text-align: center;"> 2NC  </div> </div>
LAM... 	Magnetic Trip Alarm Switch <ul style="list-style-type: none"> • Operates in case of instantaneous trip • Side mounting on the left • 2-pole • Set LAM first in case of using LX together 	<div style="display: flex; justify-content: space-around;"> <div style="text-align: center;"> 1NO1NC  </div> <div style="text-align: center;"> 2NO  </div> <div style="text-align: center;"> 2NC  </div> </div>

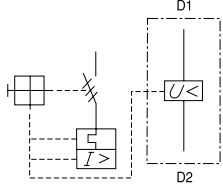
Auxiliaries

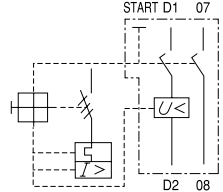
Type	Description	Connection diagram
RS... 	Shunt release <ul style="list-style-type: none"> • Side mounting on the right • One side mounting module per circuit breaker. • Can not use with RU or RUX 	 <p>24V 50Hz / 28V 60Hz 110V 50Hz / 120V 60Hz 200V 50Hz / 200~220V 60Hz 220~230V 50Hz / 240~260V 60Hz 240V 50Hz / 277V 60Hz 380~400V 50Hz / 440~460V 60Hz 415~440V 50Hz / 460~480V 60Hz</p>
RU... 	Undervoltage release <ul style="list-style-type: none"> • Side mounting on the right • One side mounting module per circuit breaker. • Can not use with RU or RUX 	 <p>24V 50Hz / 28V 60Hz 110V 50Hz / 120V 60Hz 200V 50Hz / 200~220V 60Hz 220~230V 50Hz / 240~260V 60Hz 240V 50Hz / 277V 60Hz 380~400V 50Hz / 440~460V 60Hz 415~440V 50Hz / 460~480V 60Hz</p>
RUX... 	Undervoltage release with Switch <ul style="list-style-type: none"> • Side mounting on the right • Include 2NO Auxiliary contact • One side mounting module per circuit breaker. • Can not use with RU or RUX • Can not attach to MMS-32S 	 <p>24V 50Hz / 28V 60Hz 110V 50Hz / 120V 60Hz 200V 50Hz / 200~220V 60Hz 220~230V 50Hz / 240~260V 60Hz 240V 50Hz / 277V 60Hz 380~400V 50Hz / 440~460V 60Hz 415~440V 50Hz / 460~480V 60Hz</p>

Auxiliaries

E-Handle (Rotary-type)



MMS E-Handle is a Rotary-type Handle accessory which can be attached to the front to control and verify the ON, TRIP, OFF condition of Manual Motor Starters under the situation of closing panel.

- Application Model : MMS-32H/HI, MMS-63S/H/HI, MMS-100S/H/HI
- Operation temp. : -20~ +60°C
- CE and UL certified
- Degree of protection : IP65
- Locking device : Lockable in on/off position
- Material of insulation : Plastic(PA66)

Type	Application MMS	Remarks
MEH-32	MMS-32H, 32HI	Length of shaft : 115 or 315mm
MEH-63	MMS-63S, 63H, 63HI	
MEH-100	MMS-100S, 100H, 100HI	

Phase Bus



It is a device for a parallel connection with power terminals in the circuit lined up by MMS, and it can provides the solution "Simple wiring" and "Compact wiring space".

- Application Model : MMS-32, 63
- CE and UL certified
- Safety Cover built-in
- RoHS compliance

Type	Application MMS	Number of Terminals	Rated current	Safety cover attached
PB-322	MMS-32S, 32H, 32HI	2	63A	PBPC-32 (32 for S, H)
PB-323		3		
PB-632	MMS-63S, 63H, 63HI	2	108A	PBPC-63
PB-633		3		

Diagram

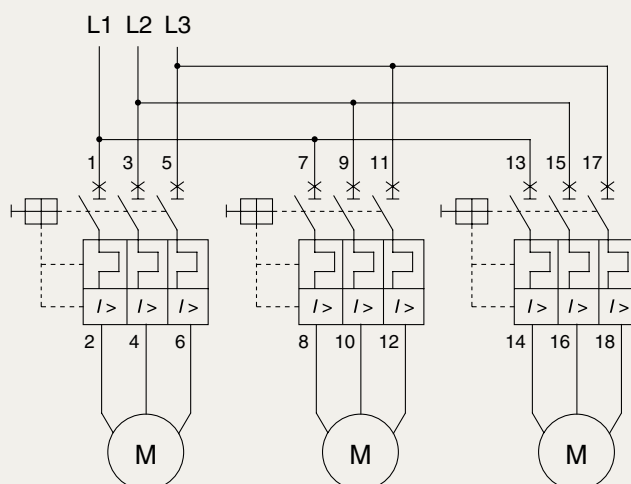
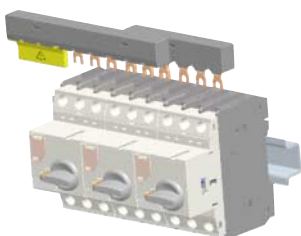



Auxiliaries

Enclosure

Case cover of MMS enclosure is specifically designed with dust-proof and corrosive-proof structure.

Therefore, it is the optimum product to use in dusty areas such as cement plants, cotton mills as well as in the presence of corrosive gas or liquid (excl. explosive, flammable gas) such as fertilizer, refinery, and plating plant.

- Application Model: MMS-32H/HI
- Operation temp. : -20~ +60 °C
- CE and UL certified
- Degree of protection : IP65
- Material of insulation :Plastic(ABS)

Type	Application MMS	Remarks
EPH-32	MMS-32H, 32HI	Surface mount



Dial Cover

Dial cover is used to protect the set value from the operation that is not intended. It is supplied as standard for all MMS.

- Application Model : MMS-32, 63,100 (All types)



Insulation Barrier

Insulation barrier is used to enlarge the creepage distance and clearance to meet the requirement of UL.

- Application Model : MMS-100

Type	Application MMS
IB100	MMS-100S, 100H, 100HI

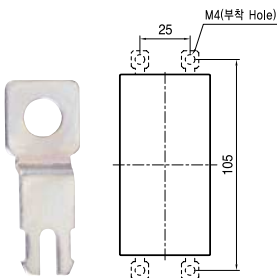

Screw mounting holder

32AF MMS is only for DIN rail mountable by itself. Screw mounting holder is used to mount MMS on a panel by screws.

- Application Model : MMS-32

Type	Application MMS	Remarks
MP-32	MMS-32S, 32H, 32HI	For M4 screw

Auxiliaries

Direct adaptor and Mounting unit

Direct adaptor, DA

Direct adaptor is used to connect MMS directly with a contactor

Mounting unit, MU

This device is attached module to connect joined MMS with a contactor

- Application Model : MMS + Metasol(MC-6a~100a), Susol(MC-9~95), Mini contactor

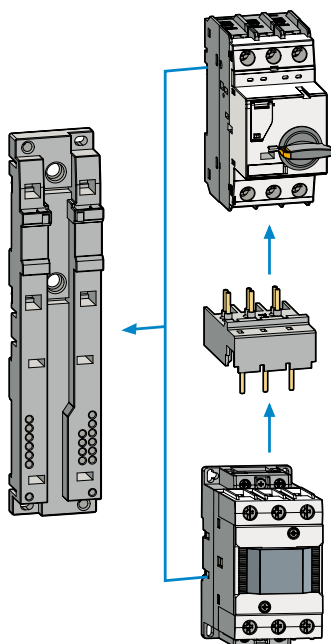

Type		Combined devices	
Direct adaptor	Mounting unit	MMS	MC
DA-16SA	MU-45	MMS-32S	Mini-MC GMC-6M~16M
DA-16SD			Mini-MC GMD-6M~16M
DA-16HA		MMS-32H, 32HI	Mini-MC GMC-6M~16M
DA-16HD			Mini-MC GMD-6M~16M
DA-18SA		MMS-32S	MC-6a~18a AC
DA-18SD			MC-6a~18a DC
DA-18HA		MMS-32H, 32HI	MC-6a~18a AC
DA-18HD			MC-6a~18a DC
DA-22SA		MMS-32S	MC-9b~22b AC
DA-22SD			MC-9b~22b DC
DA-22HA		MMS-32H, 32HI	MC-9b~22b AC
DA-22HD			MC-9b~22b DC
DA-32SA		MMS-32S	MC-32a~40a AC, MC-9~32 AC
DA-32SD			MC-32a~40a DC, MC-9~32 DC
DA-32HA		MMS-32H, 32HI	MC-32a~40a AC, MC-9~32 AC
DA-32HD			MC-32a~40a DC, MC-9~32 DC
DA-63A	MU-55	MMS-63S, 63H, 63HI	MC-50a~65a AC Lug, MC-35~63 AC Lug
DA-63D			MC-50a~65a DC Lug, MC-35~63 DC Lug
DA-95A	MU-70	MMS-100S, 100H, 100HI	MC-75a~100a AC Lug, MC-65~95 AC Lug
DA-95D			MC-75a~100a DC Lug, MC-65~95 DC Lug



Note) MMS and Contactor connected with Direct adaptor.

Manual motor starters

MMS-32S

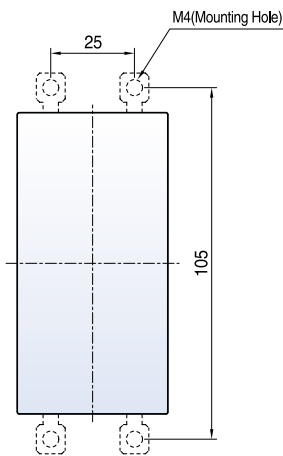
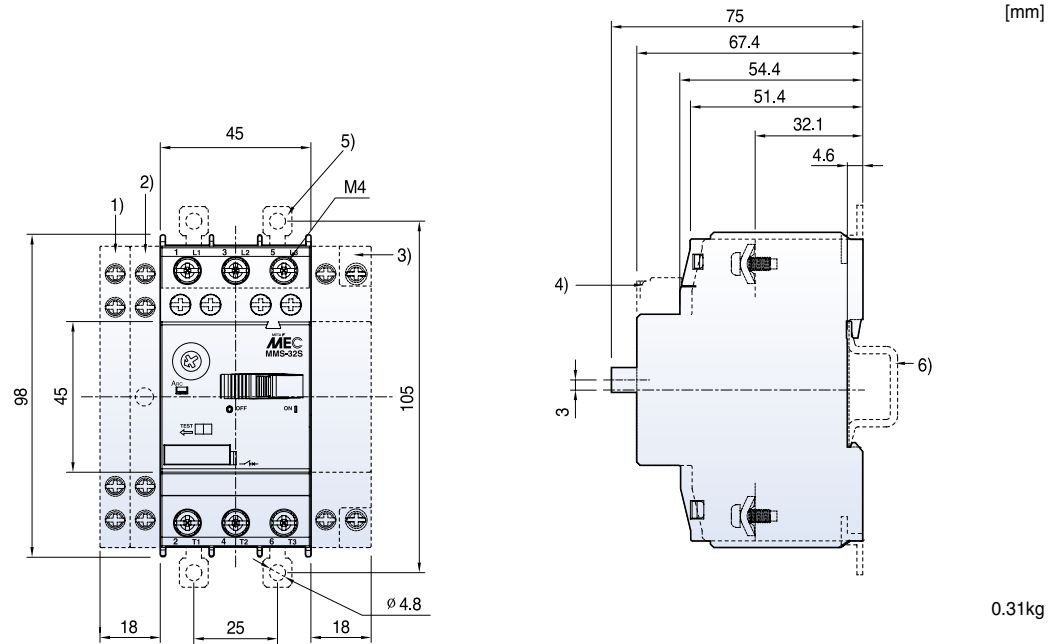

- 1) Side auxiliary switch
- 2) Side magnetic trip alarm switch
- 3) Side shunt release or Side undervoltage release
- 4) Front auxiliary switch
- 5) Push-in Lugs for screw mounting
- 6) 35mm standard mounting rail acc. to EN 50 022

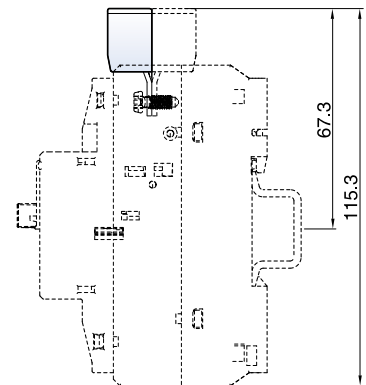
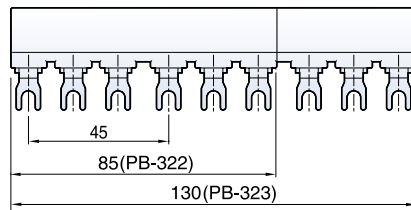

Manual motor starters

- MMS-32H
- MMS-32HI

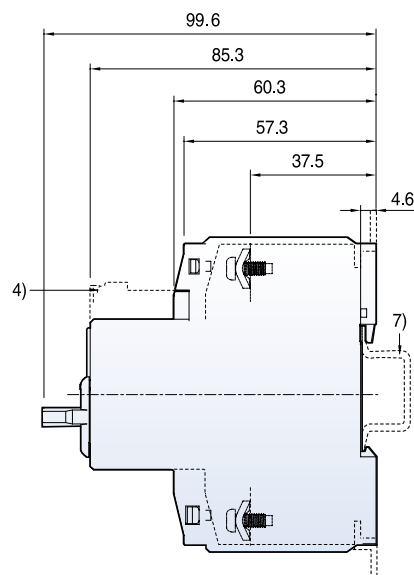
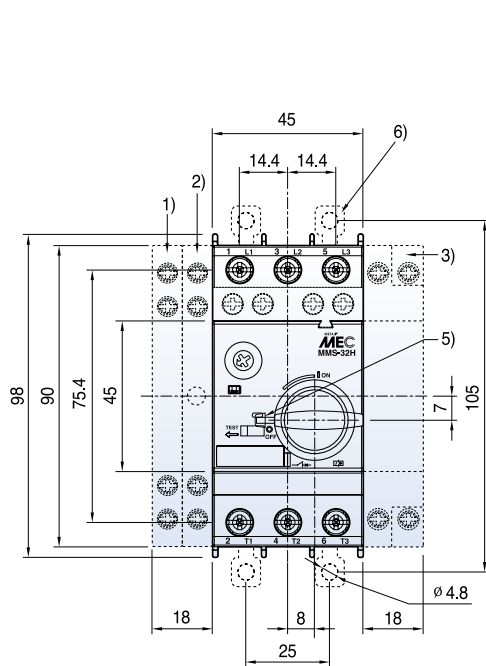

[mm]

0.4kg

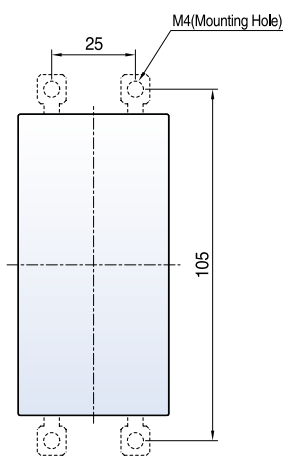

- 1) Side auxiliary switch
- 2) Side magnetic trip alarm switch
- 3) Side shunt release or Side undervoltage release
- 4) Front auxiliary switch
- 5) Handle lock in OFF position (Ø5mm)
- 6) Push-in Lugs for screw mounting
- 7) 35mm standard mounting rail acc. to EN 50 022

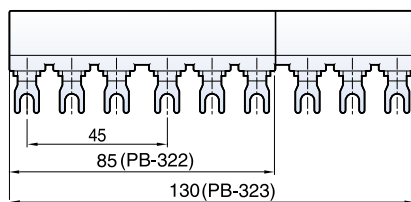

MMS-32H/HI+PB-32 (2,3P)
PB-322 (2P), PB-323 (3P)

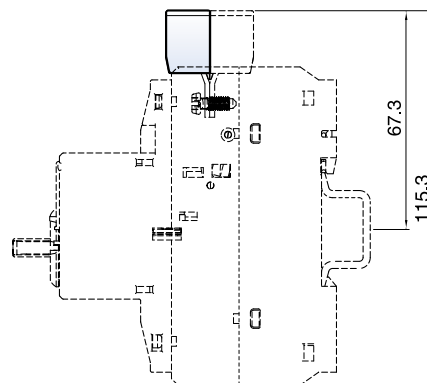

Dimensions

Manual motor starters

- MMS-63S
- MMS-63H
- MMS-63HI

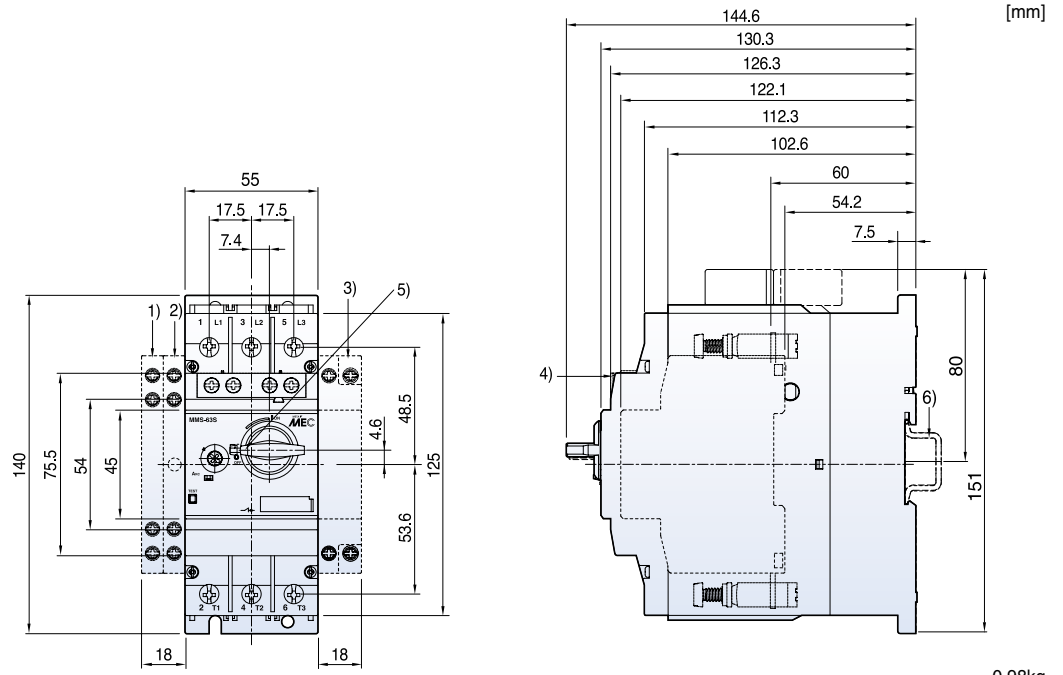

[mm]

0.98kg

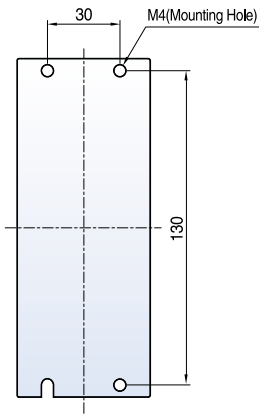

- 1) Side auxiliary switch
- 2) Side magnetic trip alarm switch
- 3) Side shunt release or Side undervoltage release
- 4) Front auxiliary switch
- 5) Handle lock in OFF position (Ø5mm)
- 6) 35mm standard mounting rail acc. to EN 50 022

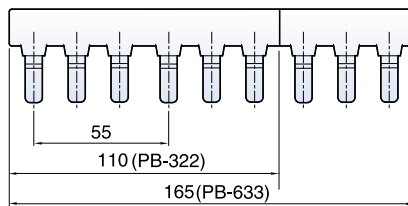

MMS-63S/H/HI+PB-63 (2,3P)
PB-632 (2P), PB-633 (3P)

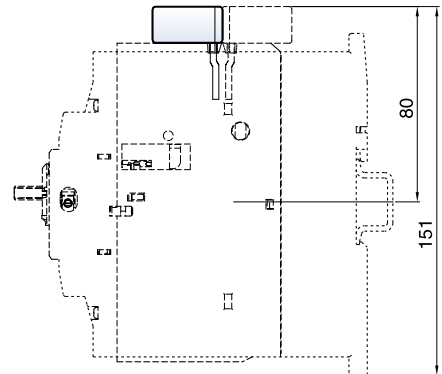

Manual motor starters

- MMS-100S
- MMS-100H
- MMS-100HI

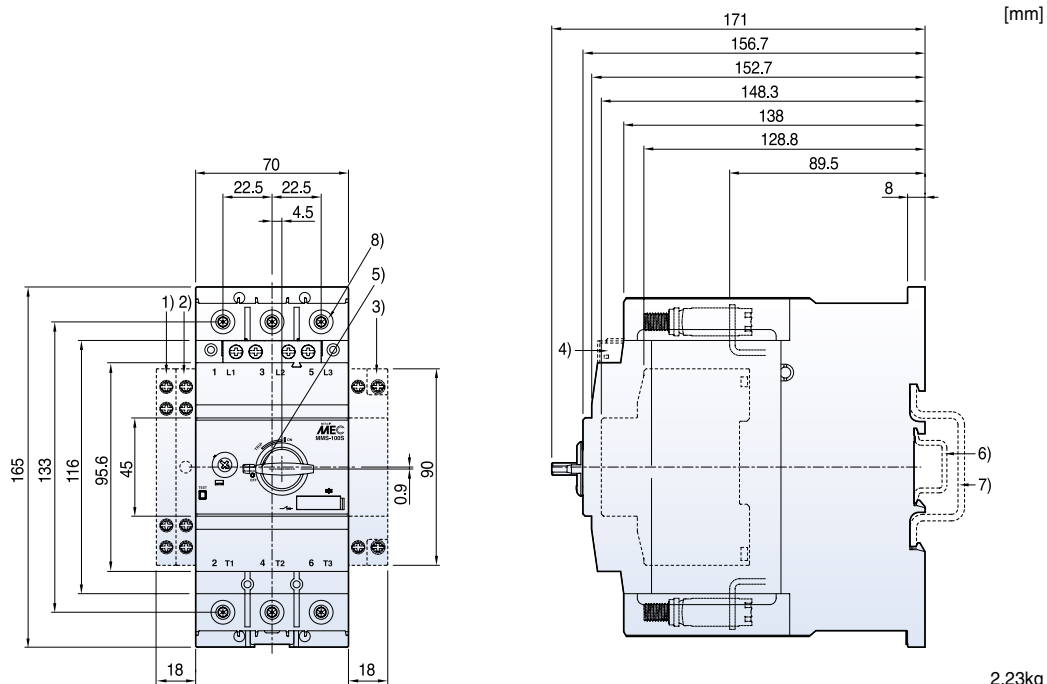

[mm]

2.23kg

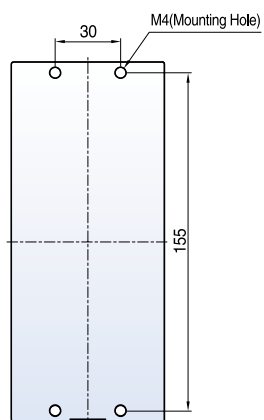

- 1) Side auxiliary switch
- 2) Side magnetic trip alarm switch
- 3) Side shunt release or Side undervoltage release
- 4) Front auxiliary switch
- 5) Handle lock in OFF position (Ø5mm)
- 6) 35mm standard mounting rail acc. to EN 50 022
- 7) 75mm standard mounting rail acc. to EN 50 023
- 8) 4mm hexagon socket screw

Combination Manual motor starters and contactors

MMS-32S

+

MC-40AF

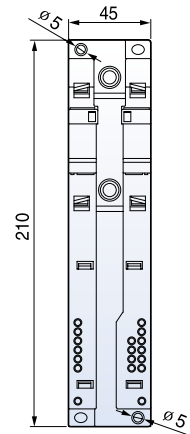
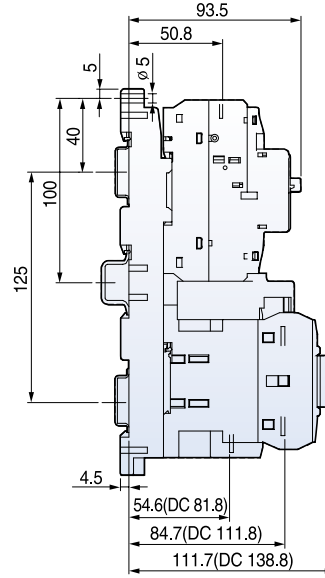
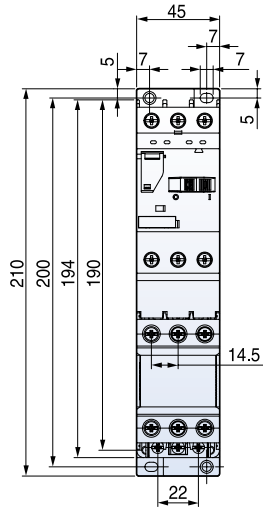

[mm]

1.1kg

MMS-32H

+

MC-40AF

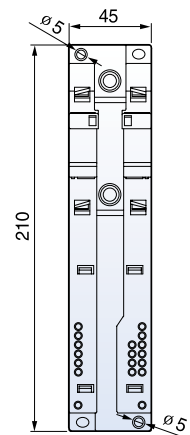
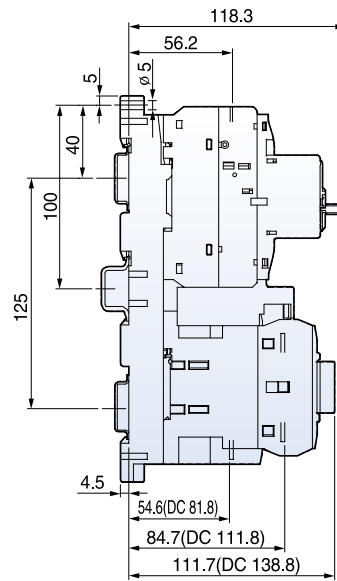
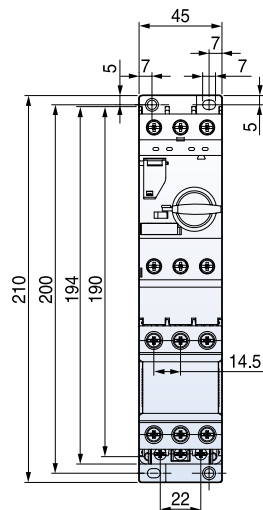

1.2kg

Combination Manual motor starters and contactors

MMS-63H
+
MC-65AF

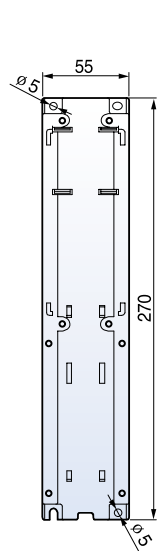
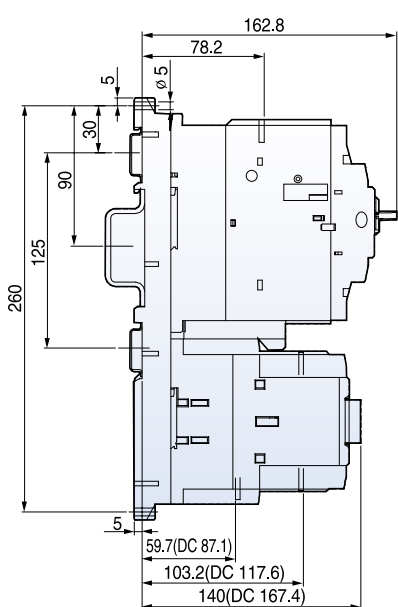
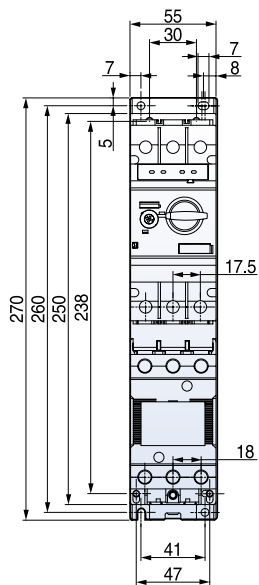

[mm]

2.3kg

MMS-100H
+
MC-100AF

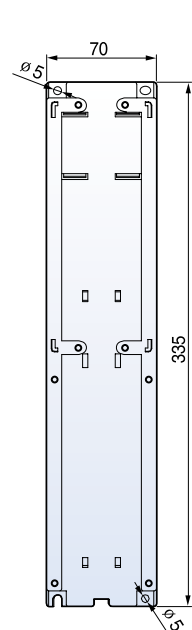
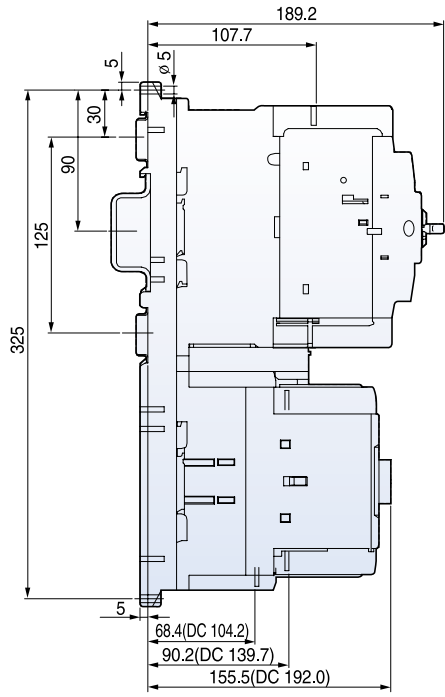
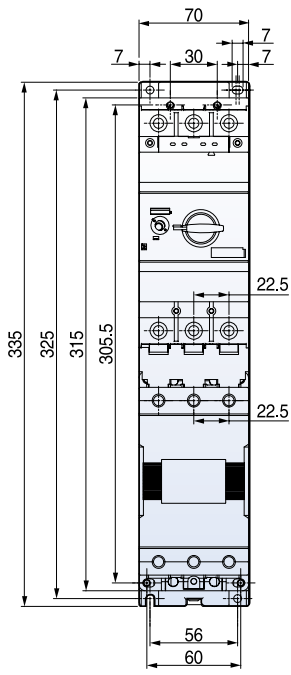

4.6kg

Contactors

MC-6a screw only type



18AF

Model	Terminal type	Coil Voltage	Frequency	Aux. Contact	Code
MC-6a	Screw	AC24V	50/60Hz	1a	1327000100
	Screw	AC48V	50/60Hz	1a	1327000200
	Screw	AC100V	50/60Hz	1a	1327000300
	Screw	AC110V	50/60Hz	1a	1327000400
	Screw	AC120V	50/60Hz	1a	1327000500
	Screw	AC200V	50/60Hz	1a	1327000600
	Screw	AC220V	50/60Hz	1a	1327000700
	Screw	AC230V	50/60Hz	1a	1327000800
	Screw	AC240V	50/60Hz	1a	1327000900
	Screw	AC380V	50/60Hz	1a	1327001000
	Screw	AC400V	50/60Hz	1a	1327001100
	Screw	AC415V	50/60Hz	1a	1327001200
	Screw	AC440V	50/60Hz	1a	1327001300
	Screw	AC500V	50/60Hz	1a	1327001400
	Screw	AC550V	50/60Hz	1a	1327001500
	Screw	AC24V	50Hz	1a	1327001600
	Screw	AC36V	50Hz	1a	1327001700
	Screw	AC42V	50Hz	1a	1327001800
	Screw	AC48V	50Hz	1a	1327001900
	Screw	AC80V	50Hz	1a	1327002000
	Screw	AC100V	50Hz	1a	1327002100
	Screw	AC110V	50Hz	1a	1327002200
	Screw	AC220V	50Hz	1a	1327002300
	Screw	AC230V	50Hz	1a	1327002400
	Screw	AC240V	50Hz	1a	1327002500
	Screw	AC380V	50Hz	1a	1327002600
	Screw	AC400V	50Hz	1a	1327002700
	Screw	AC415V	50Hz	1a	1327002800
	Screw	AC440V	50Hz	1a	1327002900
	Screw	AC500V	50Hz	1a	1327003000
	Screw	AC550V	50Hz	1a	1327003100
	Screw	AC24V	60Hz	1a	1327003200
	Screw	AC48V	60Hz	1a	1327003300
	Screw	AC100V	60Hz	1a	1327003400
	Screw	AC110V	60Hz	1a	1327003500
	Screw	AC120V	60Hz	1a	1327003600
	Screw	AC200V	60Hz	1a	1327003700
	Screw	AC208V	60Hz	1a	1327003800
	Screw	AC220V	60Hz	1a	1327003900
	Screw	AC230V	60Hz	1a	1327004000
	Screw	AC240V	60Hz	1a	1327004100
	Screw	AC277V	60Hz	1a	1327004200
	Screw	AC380V	60Hz	1a	1327004300
	Screw	AC440V	60Hz	1a	1327004400
	Screw	AC480V	60Hz	1a	1327004500
	Screw	AC600V	60Hz	1a	1327004600
	Screw	AC100V, 110V	50Hz, 60Hz	1a	1327004700
	Screw	AC110V, 120V	50Hz, 60Hz	1a	1327004800
	Screw	AC200V, 220V	50Hz, 60Hz	1a	1327004900
	Screw	AC240V, 277V	50Hz, 60Hz	1a	1327005000
Screw	DC12V	-	1a	1327005100	
Screw	DC20V	-	1a	1327005200	
Screw	DC24V	-	1a	1327005300	
Screw	DC48V	-	1a	1327005400	
Screw	DC60V	-	1a	1327005500	
Screw	DC80V	-	1a	1327005600	
Screw	DC100V	-	1a	1327005700	
Screw	DC110V	-	1a	1327005800	
Screw	DC125V	-	1a	1327005900	
Screw	DC200V	-	1a	1327006000	
Screw	DC250V	-	1a	1327006100	
Screw	DC220V	-	1a	1327006200	

Contactors

MC-6a screw only type



18AF

Model	Terminal type	Coil Voltage	Frequency	Aux. Contact	Code
MC-6a	Screw	AC24V	50/60Hz	1b	1327006300
	Screw	AC48V	50/60Hz	1b	1327006400
	Screw	AC100V	50/60Hz	1b	1327006500
	Screw	AC110V	50/60Hz	1b	1327006600
	Screw	AC120V	50/60Hz	1b	1327006700
	Screw	AC200V	50/60Hz	1b	1327006800
	Screw	AC220V	50/60Hz	1b	1327006900
	Screw	AC230V	50/60Hz	1b	1327007000
	Screw	AC240V	50/60Hz	1b	1327007100
	Screw	AC380V	50/60Hz	1b	1327007200
	Screw	AC400V	50/60Hz	1b	1327007300
	Screw	AC415V	50/60Hz	1b	1327007400
	Screw	AC440V	50/60Hz	1b	1327007500
	Screw	AC500V	50/60Hz	1b	1327007600
	Screw	AC550V	50/60Hz	1b	1327007700
	Screw	AC24V	50Hz	1b	1327007800
	Screw	AC36V	50Hz	1b	1327007900
	Screw	AC42V	50Hz	1b	1327008000
	Screw	AC48V	50Hz	1b	1327008100
	Screw	AC80V	50Hz	1b	1327008200
	Screw	AC100V	50Hz	1b	1327008300
	Screw	AC110V	50Hz	1b	1327008400
	Screw	AC220V	50Hz	1b	1327008500
	Screw	AC230V	50Hz	1b	1327008600
	Screw	AC240V	50Hz	1b	1327008700
	Screw	AC380V	50Hz	1b	1327008800
	Screw	AC400V	50Hz	1b	1327008900
	Screw	AC415V	50Hz	1b	1327009000
	Screw	AC440V	50Hz	1b	1327009100
	Screw	AC500V	50Hz	1b	1327009200
	Screw	AC550V	50Hz	1b	1327009300
	Screw	AC24V	60Hz	1b	1327009400
	Screw	AC48V	60Hz	1b	1327009500
	Screw	AC100V	60Hz	1b	1327009600
	Screw	AC110V	60Hz	1b	1327009700
	Screw	AC120V	60Hz	1b	1327009800
	Screw	AC200V	60Hz	1b	1327009900
	Screw	AC208V	60Hz	1b	1327010000
	Screw	AC220V	60Hz	1b	1327010100
	Screw	AC230V	60Hz	1b	1327010200
	Screw	AC240V	60Hz	1b	1327010300
	Screw	AC277V	60Hz	1b	1327010400
	Screw	AC380V	60Hz	1b	1327010500
	Screw	AC440V	60Hz	1b	1327010600
	Screw	AC480V	60Hz	1b	1327010700
Screw	AC600V	60Hz	1b	1327010800	
Screw	AC100V, 110V	50Hz, 60Hz	1b	1327010900	
Screw	AC110V, 120V	50Hz, 60Hz	1b	1327011000	
Screw	AC200V, 220V	50Hz, 60Hz	1b	1327011100	
Screw	AC240V, 277V	50Hz, 60Hz	1b	1327011200	
Screw	DC12V	-	1b	1327011300	
Screw	DC20V	-	1b	1327011400	
Screw	DC24V	-	1b	1327011500	
Screw	DC48V	-	1b	1327011600	
Screw	DC60V	-	1b	1327011700	
Screw	DC80V	-	1b	1327011800	
Screw	DC100V	-	1b	1327011900	
Screw	DC110V	-	1b	1327012000	
Screw	DC125V	-	1b	1327012100	
Screw	DC200V	-	1b	1327012200	
Screw	DC250V	-	1b	1327012300	
Screw	DC220V	-	1b	1327012400	

Contactors

MC-9a screw only type



18AF

Model	Terminal type	Coil Voltage	Frequency	Aux. Contact	Code
MC-9a	Screw	AC24V	50/60Hz	1a	1316000100
	Screw	AC48V	50/60Hz	1a	1316000200
	Screw	AC100V	50/60Hz	1a	1316000300
	Screw	AC110V	50/60Hz	1a	1316000400
	Screw	AC120V	50/60Hz	1a	1316000500
	Screw	AC200V	50/60Hz	1a	1316000600
	Screw	AC220V	50/60Hz	1a	1316000700
	Screw	AC230V	50/60Hz	1a	1316000800
	Screw	AC240V	50/60Hz	1a	1316000900
	Screw	AC380V	50/60Hz	1a	1316001000
	Screw	AC400V	50/60Hz	1a	1316001100
	Screw	AC415V	50/60Hz	1a	1316001200
	Screw	AC440V	50/60Hz	1a	1316001300
	Screw	AC500V	50/60Hz	1a	1316001400
	Screw	AC550V	50/60Hz	1a	1316001500
	Screw	AC24V	50Hz	1a	1316001600
	Screw	AC36V	50Hz	1a	1316001700
	Screw	AC42V	50Hz	1a	1316001800
	Screw	AC48V	50Hz	1a	1316001900
	Screw	AC80V	50Hz	1a	1316002000
	Screw	AC100V	50Hz	1a	1316002100
	Screw	AC110V	50Hz	1a	1316002200
	Screw	AC220V	50Hz	1a	1316002300
	Screw	AC230V	50Hz	1a	1316002400
	Screw	AC240V	50Hz	1a	1316002500
	Screw	AC380V	50Hz	1a	1316002600
	Screw	AC400V	50Hz	1a	1316002700
	Screw	AC415V	50Hz	1a	1316002800
	Screw	AC440V	50Hz	1a	1316002900
	Screw	AC500V	50Hz	1a	1316003000
	Screw	AC550V	50Hz	1a	1316003100
	Screw	AC24V	60Hz	1a	1316003200
	Screw	AC48V	60Hz	1a	1316003300
	Screw	AC100V	60Hz	1a	1316003400
	Screw	AC110V	60Hz	1a	1316003500
	Screw	AC120V	60Hz	1a	1316003600
	Screw	AC200V	60Hz	1a	1316003700
	Screw	AC208V	60Hz	1a	1316003800
	Screw	AC220V	60Hz	1a	1316003900
	Screw	AC230V	60Hz	1a	1316004000
	Screw	AC240V	60Hz	1a	1316004100
	Screw	AC277V	60Hz	1a	1316004200
	Screw	AC380V	60Hz	1a	1316004300
	Screw	AC440V	60Hz	1a	1316004400
	Screw	AC480V	60Hz	1a	1316004500
Screw	AC600V	60Hz	1a	1316004600	
Screw	AC100V, 110V	50Hz, 60Hz	1a	1316004700	
Screw	AC110V, 120V	50Hz, 60Hz	1a	1316004800	
Screw	AC200V, 220V	50Hz, 60Hz	1a	1316004900	
Screw	AC240V, 277V	50Hz, 60Hz	1a	1316005000	
Screw	DC12V	-	1a	1316005100	
Screw	DC20V	-	1a	1316005200	
Screw	DC24V	-	1a	1316005300	
Screw	DC48V	-	1a	1316005400	
Screw	DC60V	-	1a	1316005500	
Screw	DC80V	-	1a	1316005600	
Screw	DC100V	-	1a	1316005700	
Screw	DC110V	-	1a	1316005800	
Screw	DC125V	-	1a	1316005900	
Screw	DC200V	-	1a	1316006000	
Screw	DC250V	-	1a	1316006100	
Screw	DC220V	-	1a	1316006200	

Contactors

MC-9a screw only type



18AF

Model	Terminal type	Coil Voltage	Frequency	Aux. Contact	Code
MC-9a	Screw	AC24V	50/60Hz	1b	1316100100
	Screw	AC48V	50/60Hz	1b	1316100200
	Screw	AC100V	50/60Hz	1b	1316100300
	Screw	AC110V	50/60Hz	1b	1316100400
	Screw	AC120V	50/60Hz	1b	1316100500
	Screw	AC200V	50/60Hz	1b	1316100600
	Screw	AC220V	50/60Hz	1b	1316100700
	Screw	AC230V	50/60Hz	1b	1316100800
	Screw	AC240V	50/60Hz	1b	1316100900
	Screw	AC380V	50/60Hz	1b	1316101000
	Screw	AC400V	50/60Hz	1b	1316101100
	Screw	AC415V	50/60Hz	1b	1316101200
	Screw	AC440V	50/60Hz	1b	1316101300
	Screw	AC500V	50/60Hz	1b	1316101400
	Screw	AC550V	50/60Hz	1b	1316101500
	Screw	AC24V	50Hz	1b	1316101600
	Screw	AC36V	50Hz	1b	1316101700
	Screw	AC42V	50Hz	1b	1316101800
	Screw	AC48V	50Hz	1b	1316101900
	Screw	AC80V	50Hz	1b	1316102000
	Screw	AC100V	50Hz	1b	1316102100
	Screw	AC110V	50Hz	1b	1316102200
	Screw	AC220V	50Hz	1b	1316102300
	Screw	AC230V	50Hz	1b	1316102400
	Screw	AC240V	50Hz	1b	1316102500
	Screw	AC380V	50Hz	1b	1316102600
	Screw	AC400V	50Hz	1b	1316102700
	Screw	AC415V	50Hz	1b	1316102800
	Screw	AC440V	50Hz	1b	1316102900
	Screw	AC500V	50Hz	1b	1316103000
	Screw	AC550V	50Hz	1b	1316103100
	Screw	AC24V	60Hz	1b	1316103200
	Screw	AC48V	60Hz	1b	1316103300
	Screw	AC100V	60Hz	1b	1316103400
	Screw	AC110V	60Hz	1b	1316103500
	Screw	AC120V	60Hz	1b	1316103600
	Screw	AC200V	60Hz	1b	1316103700
	Screw	AC208V	60Hz	1b	1316103800
	Screw	AC220V	60Hz	1b	1316103900
	Screw	AC230V	60Hz	1b	1316104000
	Screw	AC240V	60Hz	1b	1316104100
	Screw	AC277V	60Hz	1b	1316104200
	Screw	AC380V	60Hz	1b	1316104300
	Screw	AC440V	60Hz	1b	1316104400
	Screw	AC480V	60Hz	1b	1316104500
Screw	AC600V	60Hz	1b	1316104600	
Screw	AC100V, 110V	50Hz	1b	1316104700	
Screw	AC110V, 120V	50Hz	1b	1316104800	
Screw	AC200V, 220V	50Hz	1b	1316104900	
Screw	AC240V, 277V	50Hz	1b	1316105000	
Screw	DC12V	-	1b	1316105100	
Screw	DC20V	-	1b	1316105200	
Screw	DC24V	-	1b	1316105300	
Screw	DC48V	-	1b	1316105400	
Screw	DC60V	-	1b	1316105500	
Screw	DC80V	-	1b	1316105600	
Screw	DC100V	-	1b	1316105700	
Screw	DC110V	-	1b	1316105800	
Screw	DC125V	-	1b	1316105900	
Screw	DC200V	-	1b	1316106000	
Screw	DC250V	-	1b	1316106100	
Screw	DC220V	-	1b	1316106200	

Contactors

MC-12a screw only type



18AF

Model	Terminal type	Coil Voltage	Frequency	Aux. Contact	Code
MC-12a	Screw	AC24V	50/60Hz	1a	1317000100
	Screw	AC48V	50/60Hz	1a	1317000200
	Screw	AC100V	50/60Hz	1a	1317000300
	Screw	AC110V	50/60Hz	1a	1317000400
	Screw	AC120V	50/60Hz	1a	1317000500
	Screw	AC200V	50/60Hz	1a	1317000600
	Screw	AC220V	50/60Hz	1a	1317000700
	Screw	AC230V	50/60Hz	1a	1317000800
	Screw	AC240V	50/60Hz	1a	1317000900
	Screw	AC380V	50/60Hz	1a	1317001000
	Screw	AC400V	50/60Hz	1a	1317001100
	Screw	AC415V	50/60Hz	1a	1317001200
	Screw	AC440V	50/60Hz	1a	1317001300
	Screw	AC500V	50/60Hz	1a	1317001400
	Screw	AC550V	50/60Hz	1a	1317001500
	Screw	AC24V	50Hz	1a	1317001600
	Screw	AC36V	50Hz	1a	1317001700
	Screw	AC42V	50Hz	1a	1317001800
	Screw	AC48V	50Hz	1a	1317001900
	Screw	AC80V	50Hz	1a	1317002000
	Screw	AC100V	50Hz	1a	1317002100
	Screw	AC110V	50Hz	1a	1317002200
	Screw	AC220V	50Hz	1a	1317002300
	Screw	AC230V	50Hz	1a	1317002400
	Screw	AC240V	50Hz	1a	1317002500
	Screw	AC380V	50Hz	1a	1317002600
	Screw	AC400V	50Hz	1a	1317002700
	Screw	AC415V	50Hz	1a	1317002800
	Screw	AC440V	50Hz	1a	1317002900
	Screw	AC500V	50Hz	1a	1317003000
	Screw	AC550V	50Hz	1a	1317003100
	Screw	AC24V	60Hz	1a	1317003200
	Screw	AC48V	60Hz	1a	1317003300
	Screw	AC100V	60Hz	1a	1317003400
	Screw	AC110V	60Hz	1a	1317003500
	Screw	AC120V	60Hz	1a	1317003600
	Screw	AC200V	60Hz	1a	1317003700
	Screw	AC208V	60Hz	1a	1317003800
	Screw	AC220V	60Hz	1a	1317003900
	Screw	AC230V	60Hz	1a	1317004000
	Screw	AC240V	60Hz	1a	1317004100
	Screw	AC277V	60Hz	1a	1317004200
	Screw	AC380V	60Hz	1a	1317004300
	Screw	AC440V	60Hz	1a	1317004400
	Screw	AC480V	60Hz	1a	1317004500
	Screw	AC600V	60Hz	1a	1317004600
	Screw	AC100V, 110V	50Hz, 60Hz	1a	1317004700
	Screw	AC110V, 120V	50Hz, 60Hz	1a	1317004800
	Screw	AC200V, 220V	50Hz, 60Hz	1a	1317004900
	Screw	AC240V, 277V	50Hz, 60Hz	1a	1317005000
Screw	DC12V	-	1a	1317005100	
Screw	DC20V	-	1a	1317005200	
Screw	DC24V	-	1a	1317005300	
Screw	DC48V	-	1a	1317005400	
Screw	DC60V	-	1a	1317005500	
Screw	DC80V	-	1a	1317005600	
Screw	DC100V	-	1a	1317005700	
Screw	DC110V	-	1a	1317005800	
Screw	DC125V	-	1a	1317005900	
Screw	DC200V	-	1a	1317006000	
Screw	DC250V	-	1a	1317006100	
Screw	DC220V	-	1a	1317006200	

Contactors

MC-12a screw only type



18AF

Model	Terminal type	Coil Voltage	Frequency	Aux. Contact	Code
MC-12a	Screw	AC24V	50/60Hz	1b	1317100100
	Screw	AC48V	50/60Hz	1b	1317100200
	Screw	AC100V	50/60Hz	1b	1317100300
	Screw	AC110V	50/60Hz	1b	1317100400
	Screw	AC120V	50/60Hz	1b	1317100500
	Screw	AC200V	50/60Hz	1b	1317100600
	Screw	AC220V	50/60Hz	1b	1317100700
	Screw	AC230V	50/60Hz	1b	1317100800
	Screw	AC240V	50/60Hz	1b	1317100900
	Screw	AC380V	50/60Hz	1b	1317101000
	Screw	AC400V	50/60Hz	1b	1317101100
	Screw	AC415V	50/60Hz	1b	1317101200
	Screw	AC440V	50/60Hz	1b	1317101300
	Screw	AC500V	50/60Hz	1b	1317101400
	Screw	AC550V	50/60Hz	1b	1317101500
	Screw	AC24V	50Hz	1b	1317101600
	Screw	AC36V	50Hz	1b	1317101700
	Screw	AC42V	50Hz	1b	1317101800
	Screw	AC48V	50Hz	1b	1317101900
	Screw	AC80V	50Hz	1b	1317102000
	Screw	AC100V	50Hz	1b	1317102100
	Screw	AC110V	50Hz	1b	1317102200
	Screw	AC220V	50Hz	1b	1317102300
	Screw	AC230V	50Hz	1b	1317102400
	Screw	AC240V	50Hz	1b	1317102500
	Screw	AC380V	50Hz	1b	1317102600
	Screw	AC400V	50Hz	1b	1317102700
	Screw	AC415V	50Hz	1b	1317102800
	Screw	AC440V	50Hz	1b	1317102900
	Screw	AC500V	50Hz	1b	1317103000
	Screw	AC550V	50Hz	1b	1317103100
	Screw	AC24V	60Hz	1b	1317103200
	Screw	AC48V	60Hz	1b	1317103300
	Screw	AC100V	60Hz	1b	1317103400
	Screw	AC110V	60Hz	1b	1317103500
	Screw	AC120V	60Hz	1b	1317103600
	Screw	AC200V	60Hz	1b	1317103700
	Screw	AC208V	60Hz	1b	1317103800
	Screw	AC220V	60Hz	1b	1317103900
	Screw	AC230V	60Hz	1b	1317104000
	Screw	AC240V	60Hz	1b	1317104100
	Screw	AC277V	60Hz	1b	1317104200
	Screw	AC380V	60Hz	1b	1317104300
	Screw	AC440V	60Hz	1b	1317104400
	Screw	AC480V	60Hz	1b	1317104500
	Screw	AC600V	60Hz	1b	1317104600
Screw	AC100V, 110V	50Hz, 60Hz	1b	1317104700	
Screw	AC110V, 120V	50Hz, 60Hz	1b	1317104800	
Screw	AC200V, 220V	50Hz, 60Hz	1b	1317104900	
Screw	AC240V, 277V	50Hz, 60Hz	1b	1317105000	
Screw	DC12V	-	1b	1317105100	
Screw	DC20V	-	1b	1317105200	
Screw	DC24V	-	1b	1317105300	
Screw	DC48V	-	1b	1317105400	
Screw	DC60V	-	1b	1317105500	
Screw	DC80V	-	1b	1317105600	
Screw	DC100V	-	1b	1317105700	
Screw	DC110V	-	1b	1317105800	
Screw	DC125V	-	1b	1317105900	
Screw	DC200V	-	1b	1317106000	
Screw	DC250V	-	1b	1317106100	
Screw	DC220V	-	1b	1317106200	

Contactors

MC-18a screw only type



18AF

Model	Terminal type	Coil Voltage	Frequency	Aux. Contact	Code
MC-18a	Screw	AC24V	50/60Hz	1a	1328000100
	Screw	AC48V	50/60Hz	1a	1328000200
	Screw	AC100V	50/60Hz	1a	1328000300
	Screw	AC110V	50/60Hz	1a	1328000400
	Screw	AC120V	50/60Hz	1a	1328000500
	Screw	AC200V	50/60Hz	1a	1328000600
	Screw	AC220V	50/60Hz	1a	1328000700
	Screw	AC230V	50/60Hz	1a	1328000800
	Screw	AC240V	50/60Hz	1a	1328000900
	Screw	AC380V	50/60Hz	1a	1328001000
	Screw	AC400V	50/60Hz	1a	1328001100
	Screw	AC415V	50/60Hz	1a	1328001200
	Screw	AC440V	50/60Hz	1a	1328001300
	Screw	AC500V	50/60Hz	1a	1328001400
	Screw	AC550V	50/60Hz	1a	1328001500
	Screw	AC24V	50Hz	1a	1328001600
	Screw	AC36V	50Hz	1a	1328001700
	Screw	AC42V	50Hz	1a	1328001800
	Screw	AC48V	50Hz	1a	1328001900
	Screw	AC80V	50Hz	1a	1328002000
	Screw	AC100V	50Hz	1a	1328002100
	Screw	AC110V	50Hz	1a	1328002200
	Screw	AC220V	50Hz	1a	1328002300
	Screw	AC230V	50Hz	1a	1328002400
	Screw	AC240V	50Hz	1a	1328002500
	Screw	AC380V	50Hz	1a	1328002600
	Screw	AC400V	50Hz	1a	1328002700
	Screw	AC415V	50Hz	1a	1328002800
	Screw	AC440V	50Hz	1a	1328002900
	Screw	AC500V	50Hz	1a	1328003000
	Screw	AC550V	50Hz	1a	1328003100
	Screw	AC24V	60Hz	1a	1328003200
	Screw	AC48V	60Hz	1a	1328003300
	Screw	AC100V	60Hz	1a	1328003400
	Screw	AC110V	60Hz	1a	1328003500
	Screw	AC120V	60Hz	1a	1328003600
	Screw	AC200V	60Hz	1a	1328003700
	Screw	AC208V	60Hz	1a	1328003800
	Screw	AC220V	60Hz	1a	1328003900
	Screw	AC230V	60Hz	1a	1328004000
	Screw	AC240V	60Hz	1a	1328004100
	Screw	AC277V	60Hz	1a	1328004200
	Screw	AC380V	60Hz	1a	1328004300
	Screw	AC440V	60Hz	1a	1328004400
	Screw	AC480V	60Hz	1a	1328004500
	Screw	AC600V	60Hz	1a	1328004600
Screw	AC100V, 110V	50Hz, 60Hz	1a	1328004700	
Screw	AC110V, 120V	50Hz, 60Hz	1a	1328004800	
Screw	AC200V, 220V	50Hz, 60Hz	1a	1328004900	
Screw	AC240V, 277V	50Hz, 60Hz	1a	1328005000	
Screw	DC12V	-	1a	1328005100	
Screw	DC20V	-	1a	1328005200	
Screw	DC24V	-	1a	1328005300	
Screw	DC48V	-	1a	1328005400	
Screw	DC60V	-	1a	1328005500	
Screw	DC80V	-	1a	1328005600	
Screw	DC100V	-	1a	1328005700	
Screw	DC110V	-	1a	1328005800	
Screw	DC125V	-	1a	1328005900	
Screw	DC200V	-	1a	1328006000	
Screw	DC250V	-	1a	1328006100	
Screw	DC220V	-	1a	1328006200	

Contactors

MC-18a screw only type



18AF

Model	Terminal type	Coil Voltage	Frequency	Aux. Contact	Code
MC-18a	Screw	AC24V	50/60Hz	1b	1328006300
	Screw	AC48V	50/60Hz	1b	1328006400
	Screw	AC100V	50/60Hz	1b	1328006500
	Screw	AC110V	50/60Hz	1b	1328006600
	Screw	AC120V	50/60Hz	1b	1328006700
	Screw	AC200V	50/60Hz	1b	1328006800
	Screw	AC220V	50/60Hz	1b	1328006900
	Screw	AC230V	50/60Hz	1b	1328007000
	Screw	AC240V	50/60Hz	1b	1328007100
	Screw	AC380V	50/60Hz	1b	1328007200
	Screw	AC400V	50/60Hz	1b	1328007300
	Screw	AC415V	50/60Hz	1b	1328007400
	Screw	AC440V	50/60Hz	1b	1328007500
	Screw	AC500V	50/60Hz	1b	1328007600
	Screw	AC550V	50/60Hz	1b	1328007700
	Screw	AC24V	50Hz	1b	1328007800
	Screw	AC36V	50Hz	1b	1328007900
	Screw	AC42V	50Hz	1b	1328008000
	Screw	AC48V	50Hz	1b	1328008100
	Screw	AC80V	50Hz	1b	1328008200
	Screw	AC100V	50Hz	1b	1328008300
	Screw	AC110V	50Hz	1b	1328008400
	Screw	AC220V	50Hz	1b	1328008500
	Screw	AC230V	50Hz	1b	1328008600
	Screw	AC240V	50Hz	1b	1328008700
	Screw	AC380V	50Hz	1b	1328008800
	Screw	AC400V	50Hz	1b	1328008900
	Screw	AC415V	50Hz	1b	1328009000
	Screw	AC440V	50Hz	1b	1328009100
	Screw	AC500V	50Hz	1b	1328009200
	Screw	AC550V	50Hz	1b	1328009300
	Screw	AC24V	60Hz	1b	1328009400
	Screw	AC48V	60Hz	1b	1328009500
	Screw	AC100V	60Hz	1b	1328009600
	Screw	AC110V	60Hz	1b	1328009700
	Screw	AC120V	60Hz	1b	1328009800
	Screw	AC200V	60Hz	1b	1328009900
	Screw	AC208V	60Hz	1b	1328010000
	Screw	AC220V	60Hz	1b	1328010100
	Screw	AC230V	60Hz	1b	1328010200
	Screw	AC240V	60Hz	1b	1328010300
	Screw	AC277V	60Hz	1b	1328010400
Screw	AC380V	60Hz	1b	1328010500	
Screw	AC440V	60Hz	1b	1328010600	
Screw	AC480V	60Hz	1b	1328010700	
Screw	AC600V	60Hz	1b	1328010800	
Screw	AC100V, 110V	50Hz, 60Hz	1b	1328010900	
Screw	AC110V, 120V	50Hz, 60Hz	1b	1328011000	
Screw	AC200V, 220V	50Hz, 60Hz	1b	1328011100	
Screw	AC240V, 277V	50Hz, 60Hz	1b	1328011200	
Screw	DC12V	-	1b	1328011300	
Screw	DC20V	-	1b	1328011400	
Screw	DC24V	-	1b	1328011500	
Screw	DC48V	-	1b	1328011600	
Screw	DC60V	-	1b	1328011700	
Screw	DC80V	-	1b	1328011800	
Screw	DC100V	-	1b	1328011900	
Screw	DC110V	-	1b	1328012000	
Screw	DC125V	-	1b	1328012100	
Screw	DC200V	-	1b	1328012200	
Screw	DC250V	-	1b	1328012300	
Screw	DC220V	-	1b	1328012400	

Contactors

MC-9b screw only type



18AF

Model	Terminal type	Coil Voltage	Frequency	Aux. Contact	Code
MC-9b	Screw	AC24V	50/60Hz	1a1b	1344000100
	Screw	AC48V	50/60Hz	1a1b	1344000200
	Screw	AC100V	50/60Hz	1a1b	1344000300
	Screw	AC110V	50/60Hz	1a1b	1344000400
	Screw	AC120V	50/60Hz	1a1b	1344000500
	Screw	AC200V	50/60Hz	1a1b	1344000600
	Screw	AC220V	50/60Hz	1a1b	1344000700
	Screw	AC230V	50/60Hz	1a1b	1344000800
	Screw	AC240V	50/60Hz	1a1b	1344000900
	Screw	AC380V	50/60Hz	1a1b	1344001000
	Screw	AC400V	50/60Hz	1a1b	1344001100
	Screw	AC415V	50/60Hz	1a1b	1344001200
	Screw	AC440V	50/60Hz	1a1b	1344001300
	Screw	AC500V	50/60Hz	1a1b	1344001400
	Screw	AC550V	50/60Hz	1a1b	1344001500
	Screw	AC24V	50Hz	1a1b	1344001600
	Screw	AC36V	50Hz	1a1b	1344001700
	Screw	AC42V	50Hz	1a1b	1344001800
	Screw	AC48V	50Hz	1a1b	1344001900
	Screw	AC80V	50Hz	1a1b	1344002000
	Screw	AC100V	50Hz	1a1b	1344002100
	Screw	AC110V	50Hz	1a1b	1344002200
	Screw	AC220V	50Hz	1a1b	1344002300
	Screw	AC230V	50Hz	1a1b	1344002400
	Screw	AC240V	50Hz	1a1b	1344002500
	Screw	AC380V	50Hz	1a1b	1344002600
	Screw	AC400V	50Hz	1a1b	1344002700
	Screw	AC415V	50Hz	1a1b	1344002800
	Screw	AC440V	50Hz	1a1b	1344002900
	Screw	AC500V	50Hz	1a1b	1344003000
	Screw	AC550V	50Hz	1a1b	1344003100
	Screw	AC24V	60Hz	1a1b	1344003200
	Screw	AC48V	60Hz	1a1b	1344003300
	Screw	AC100V	60Hz	1a1b	1344003400
	Screw	AC110V	60Hz	1a1b	1344003500
	Screw	AC120V	60Hz	1a1b	1344003600
	Screw	AC200V	60Hz	1a1b	1344003700
	Screw	AC208V	60Hz	1a1b	1344003800
	Screw	AC220V	60Hz	1a1b	1344003900
	Screw	AC230V	60Hz	1a1b	1344004000
	Screw	AC240V	60Hz	1a1b	1344004100
	Screw	AC277V	60Hz	1a1b	1344004200
	Screw	AC380V	60Hz	1a1b	1344004300
	Screw	AC440V	60Hz	1a1b	1344004400
	Screw	AC480V	60Hz	1a1b	1344004500
	Screw	AC600V	60Hz	1a1b	1344004600
	Screw	AC100V, 110V	50Hz, 60Hz	1a1b	1344004700
	Screw	AC110V, 120V	50Hz, 61Hz	1a1b	1344004800
	Screw	AC200V, 220V	50Hz, 62Hz	1a1b	1344004900
	Screw	AC240V, 277V	50Hz, 63Hz	1a1b	1344005000
Screw	DC12V	-	1a1b	1344005100	
Screw	DC20V	-	1a1b	1344005200	
Screw	DC24V	-	1a1b	1344005300	
Screw	DC48V	-	1a1b	1344005400	
Screw	DC60V	-	1a1b	1344005500	
Screw	DC80V	-	1a1b	1344005600	
Screw	DC100V	-	1a1b	1344005700	
Screw	DC110V	-	1a1b	1344005800	
Screw	DC125V	-	1a1b	1344005900	
Screw	DC200V	-	1a1b	1344006000	
Screw	DC250V	-	1a1b	1344006100	
Screw	DC220V	-	1a1b	1344006200	

Contactors

MC-9b screw only type



18AF

Model	Terminal type	Coil Voltage	Frequency	Aux. Contact	Code	
MC-12b	Screw	AC24V	50/60Hz	1a1b	1345000100	
	Screw	AC48V	50/60Hz	1a1b	1345000200	
	Screw	AC100V	50/60Hz	1a1b	1345000300	
	Screw	AC110V	50/60Hz	1a1b	1345000400	
	Screw	AC120V	50/60Hz	1a1b	1345000500	
	Screw	AC200V	50/60Hz	1a1b	1345000600	
	Screw	AC220V	50/60Hz	1a1b	1345000700	
	Screw	AC230V	50/60Hz	1a1b	1345000800	
	Screw	AC240V	50/60Hz	1a1b	1345000900	
	Screw	AC380V	50/60Hz	1a1b	1345001000	
	Screw	AC400V	50/60Hz	1a1b	1345001100	
	Screw	AC415V	50/60Hz	1a1b	1345001200	
	Screw	AC440V	50/60Hz	1a1b	1345001300	
	Screw	AC500V	50/60Hz	1a1b	1345001400	
	Screw	AC550V	50/60Hz	1a1b	1345001500	
	Screw	AC24V	50Hz	1a1b	1345001600	
	Screw	AC36V	50Hz	1a1b	1345001700	
	Screw	AC42V	50Hz	1a1b	1345001800	
	Screw	AC48V	50Hz	1a1b	1345001900	
	Screw	AC80V	50Hz	1a1b	1345002000	
	Screw	AC100V	50Hz	1a1b	1345002100	
	Screw	AC110V	50Hz	1a1b	1345002200	
	Screw	AC220V	50Hz	1a1b	1345002300	
	Screw	AC230V	50Hz	1a1b	1345002400	
	Screw	AC240V	50Hz	1a1b	1345002500	
	Screw	AC380V	50Hz	1a1b	1345002600	
	Screw	AC400V	50Hz	1a1b	1345002700	
	Screw	AC415V	50Hz	1a1b	1345002800	
	Screw	AC440V	50Hz	1a1b	1345002900	
	Screw	AC500V	50Hz	1a1b	1345003000	
	MC-9b	Screw	AC550V	50Hz	1a1b	1345003100
		Screw	AC24V	60Hz	1a1b	1345003200
		Screw	AC48V	60Hz	1a1b	1345003300
Screw		AC100V	60Hz	1a1b	1345003400	
Screw		AC110V	60Hz	1a1b	1345003500	
Screw		AC120V	60Hz	1a1b	1345003600	
Screw		AC200V	60Hz	1a1b	1345003700	
Screw		AC208V	60Hz	1a1b	1345003800	
Screw		AC220V	60Hz	1a1b	1345003900	
Screw		AC230V	60Hz	1a1b	1345004000	
Screw		AC240V	60Hz	1a1b	1345004100	
Screw		AC277V	60Hz	1a1b	1345004200	
Screw		AC380V	60Hz	1a1b	1345004300	
Screw		AC440V	60Hz	1a1b	1345004400	
Screw		AC480V	60Hz	1a1b	1345004500	
Screw		AC600V	60Hz	1a1b	1345004600	
Screw		AC100V, 110V	50Hz, 60Hz	1a1b	1345004700	
Screw		AC110V, 120V	50Hz, 61Hz	1a1b	1345004800	
Screw		AC200V, 220V	50Hz, 62Hz	1a1b	1345004900	
Screw		AC240V, 277V	50Hz, 63Hz	1a1b	1345005000	
Screw		DC12V	-	1a1b	1345005100	
Screw		DC20V	-	1a1b	1345005200	
Screw		DC24V	-	1a1b	1345005300	
Screw		DC48V	-	1a1b	1345005400	
Screw		DC60V	-	1a1b	1345005500	
Screw		DC80V	-	1a1b	1345005600	
Screw		DC100V	-	1a1b	1345005700	
Screw		DC110V	-	1a1b	1345005800	
Screw		DC125V	-	1a1b	1345005900	
Screw		DC200V	-	1a1b	1345006000	
Screw		DC250V	-	1a1b	1345006100	
Screw		DC220V	-	1a1b	1345006200	

Contactors

MC-18b screw only type



22AF

Model	Terminal type	Coil Voltage	Frequency	Aux. Contact	Code
MC-18b	Screw	AC24V	50/60Hz	1a1b	1346000100
	Screw	AC48V	50/60Hz	1a1b	1346000200
	Screw	AC100V	50/60Hz	1a1b	1346000300
	Screw	AC110V	50/60Hz	1a1b	1346000400
	Screw	AC120V	50/60Hz	1a1b	1346000500
	Screw	AC200V	50/60Hz	1a1b	1346000600
	Screw	AC220V	50/60Hz	1a1b	1346000700
	Screw	AC230V	50/60Hz	1a1b	1346000800
	Screw	AC240V	50/60Hz	1a1b	1346000900
	Screw	AC380V	50/60Hz	1a1b	1346001000
	Screw	AC400V	50/60Hz	1a1b	1346001100
	Screw	AC415V	50/60Hz	1a1b	1346001200
	Screw	AC440V	50/60Hz	1a1b	1346001300
	Screw	AC500V	50/60Hz	1a1b	1346001400
	Screw	AC550V	50/60Hz	1a1b	1346001500
	Screw	AC24V	50Hz	1a1b	1346001600
	Screw	AC36V	50Hz	1a1b	1346001700
	Screw	AC42V	50Hz	1a1b	1346001800
	Screw	AC48V	50Hz	1a1b	1346001900
	Screw	AC80V	50Hz	1a1b	1346002000
	Screw	AC100V	50Hz	1a1b	1346002100
	Screw	AC110V	50Hz	1a1b	1346002200
	Screw	AC220V	50Hz	1a1b	1346002300
	Screw	AC230V	50Hz	1a1b	1346002400
	Screw	AC240V	50Hz	1a1b	1346002500
	Screw	AC380V	50Hz	1a1b	1346002600
	Screw	AC400V	50Hz	1a1b	1346002700
	Screw	AC415V	50Hz	1a1b	1346002800
	Screw	AC440V	50Hz	1a1b	1346002900
	Screw	AC500V	50Hz	1a1b	1346003000
	Screw	AC550V	50Hz	1a1b	1346003100
	Screw	AC24V	60Hz	1a1b	1346003200
	Screw	AC48V	60Hz	1a1b	1346003300
	Screw	AC100V	60Hz	1a1b	1346003400
	Screw	AC110V	60Hz	1a1b	1346003500
	Screw	AC120V	60Hz	1a1b	1346003600
	Screw	AC200V	60Hz	1a1b	1346003700
	Screw	AC208V	60Hz	1a1b	1346003800
	Screw	AC220V	60Hz	1a1b	1346003900
	Screw	AC230V	60Hz	1a1b	1346004000
	Screw	AC240V	60Hz	1a1b	1346004100
	Screw	AC277V	60Hz	1a1b	1346004200
	Screw	AC380V	60Hz	1a1b	1346004300
	Screw	AC440V	60Hz	1a1b	1346004400
	Screw	AC480V	60Hz	1a1b	1346004500
	Screw	AC600V	60Hz	1a1b	1346004600
	Screw	AC100V, 110V	50Hz, 60Hz	1a1b	1346004700
	Screw	AC110V, 120V	50Hz, 61Hz	1a1b	1346004800
	Screw	AC200V, 220V	50Hz, 62Hz	1a1b	1346004900
	Screw	AC240V, 277V	50Hz, 63Hz	1a1b	1346005000
Screw	DC12V	-	1a1b	1346005100	
Screw	DC20V	-	1a1b	1346005200	
Screw	DC24V	-	1a1b	1346005300	
Screw	DC48V	-	1a1b	1346005400	
Screw	DC60V	-	1a1b	1346005500	
Screw	DC80V	-	1a1b	1346005600	
Screw	DC100V	-	1a1b	1346005700	
Screw	DC110V	-	1a1b	1346005800	
Screw	DC125V	-	1a1b	1346005900	
Screw	DC200V	-	1a1b	1346006000	
Screw	DC250V	-	1a1b	1346006100	
Screw	DC220V	-	1a1b	1346006200	

Contactors

MC-22b screw only type



22AF

Model	Terminal type	Coil Voltage	Frequency	Aux. Contact	Code
MC-22b	Screw	AC24V	50/60Hz	1a1b	1347000100
	Screw	AC48V	50/60Hz	1a1b	1347000200
	Screw	AC100V	50/60Hz	1a1b	1347000300
	Screw	AC110V	50/60Hz	1a1b	1347000400
	Screw	AC120V	50/60Hz	1a1b	1347000500
	Screw	AC200V	50/60Hz	1a1b	1347000600
	Screw	AC220V	50/60Hz	1a1b	1347000700
	Screw	AC230V	50/60Hz	1a1b	1347000800
	Screw	AC240V	50/60Hz	1a1b	1347000900
	Screw	AC380V	50/60Hz	1a1b	1347001000
	Screw	AC400V	50/60Hz	1a1b	1347001100
	Screw	AC415V	50/60Hz	1a1b	1347001200
	Screw	AC440V	50/60Hz	1a1b	1347001300
	Screw	AC500V	50/60Hz	1a1b	1347001400
	Screw	AC550V	50/60Hz	1a1b	1347001500
	Screw	AC24V	50Hz	1a1b	1347001600
	Screw	AC36V	50Hz	1a1b	1347001700
	Screw	AC42V	50Hz	1a1b	1347001800
	Screw	AC48V	50Hz	1a1b	1347001900
	Screw	AC80V	50Hz	1a1b	1347002000
	Screw	AC100V	50Hz	1a1b	1347002100
	Screw	AC110V	50Hz	1a1b	1347002200
	Screw	AC220V	50Hz	1a1b	1347002300
	Screw	AC230V	50Hz	1a1b	1347002400
	Screw	AC240V	50Hz	1a1b	1347002500
	Screw	AC380V	50Hz	1a1b	1347002600
	Screw	AC400V	50Hz	1a1b	1347002700
	Screw	AC415V	50Hz	1a1b	1347002800
	Screw	AC440V	50Hz	1a1b	1347002900
	Screw	AC500V	50Hz	1a1b	1347003000
	Screw	AC550V	50Hz	1a1b	1347003100
	Screw	AC24V	60Hz	1a1b	1347003200
	Screw	AC48V	60Hz	1a1b	1347003300
	Screw	AC100V	60Hz	1a1b	1347003400
	Screw	AC110V	60Hz	1a1b	1347003500
	Screw	AC120V	60Hz	1a1b	1347003600
	Screw	AC200V	60Hz	1a1b	1347003700
	Screw	AC208V	60Hz	1a1b	1347003800
	Screw	AC220V	60Hz	1a1b	1347003900
	Screw	AC230V	60Hz	1a1b	1347004000
	Screw	AC240V	60Hz	1a1b	1347004100
	Screw	AC277V	60Hz	1a1b	1347004200
	Screw	AC380V	60Hz	1a1b	1347004300
	Screw	AC440V	60Hz	1a1b	1347004400
	Screw	AC480V	60Hz	1a1b	1347004500
Screw	AC600V	60Hz	1a1b	1347004600	
Screw	AC100V, 110V	50Hz, 60Hz	1a1b	1347004700	
Screw	AC110V, 120V	50Hz, 61Hz	1a1b	1347004800	
Screw	AC200V, 220V	50Hz, 62Hz	1a1b	1347004900	
Screw	AC240V, 277V	50Hz, 63Hz	1a1b	1347005000	
Screw	DC12V	-	1a1b	1347005100	
Screw	DC20V	-	1a1b	1347005200	
Screw	DC24V	-	1a1b	1347005300	
Screw	DC48V	-	1a1b	1347005400	
Screw	DC60V	-	1a1b	1347005500	
Screw	DC80V	-	1a1b	1347005600	
Screw	DC100V	-	1a1b	1347005700	
Screw	DC110V	-	1a1b	1347005800	
Screw	DC125V	-	1a1b	1347005900	
Screw	DC200V	-	1a1b	1347006000	
Screw	DC250V	-	1a1b	1347006100	
Screw	DC220V	-	1a1b	1347006200	

Contactors

MC-32a screw only type



40AF

Model	Terminal type	Coil Voltage	Frequency	Aux. Contact	Code
MC-32a	Screw	AC24V	50/60Hz	-	1336000100
	Screw	AC48V	50/60Hz	-	1336000200
	Screw	AC100V	50/60Hz	-	1336000300
	Screw	AC110V	50/60Hz	-	1336000400
	Screw	AC120V	50/60Hz	-	1336000500
	Screw	AC200V	50/60Hz	-	1336000600
	Screw	AC220V	50/60Hz	-	1336000700
	Screw	AC230V	50/60Hz	-	1336000800
	Screw	AC240V	50/60Hz	-	1336000900
	Screw	AC380V	50/60Hz	-	1336001000
	Screw	AC400V	50/60Hz	-	1336001100
	Screw	AC415V	50/60Hz	-	1336001200
	Screw	AC440V	50/60Hz	-	1336001300
	Screw	AC500V	50/60Hz	-	1336001400
	Screw	AC550V	50/60Hz	-	1336001500
	Screw	AC24V	50Hz	-	1336001600
	Screw	AC36V	50Hz	-	1336001700
	Screw	AC42V	50Hz	-	1336001800
	Screw	AC48V	50Hz	-	1336001900
	Screw	AC80V	50Hz	-	1336002000
	Screw	AC100V	50Hz	-	1336002100
	Screw	AC110V	50Hz	-	1336002200
	Screw	AC220V	50Hz	-	1336002300
	Screw	AC230V	50Hz	-	1336002400
	Screw	AC240V	50Hz	-	1336002500
	Screw	AC380V	50Hz	-	1336002600
	Screw	AC400V	50Hz	-	1336002700
	Screw	AC415V	50Hz	-	1336002800
	Screw	AC440V	50Hz	-	1336002900
	Screw	AC500V	50Hz	-	1336003000
	Screw	AC550V	50Hz	-	1336003100
	Screw	AC24V	60Hz	-	1336003200
	Screw	AC48V	60Hz	-	1336003300
	Screw	AC100V	60Hz	-	1336003400
	Screw	AC110V	60Hz	-	1336003500
	Screw	AC120V	60Hz	-	1336003600
	Screw	AC200V	60Hz	-	1336003700
	Screw	AC208V	60Hz	-	1336003800
	Screw	AC220V	60Hz	-	1336003900
	Screw	AC230V	60Hz	-	1336004000
	Screw	AC240V	60Hz	-	1336004100
	Screw	AC277V	60Hz	-	1336004200
	Screw	AC380V	60Hz	-	1336004300
	Screw	AC440V	60Hz	-	1336004400
	Screw	AC480V	60Hz	-	1336004500
	Screw	AC600V	60Hz	-	1336004600
	Screw	AC100V, 110V	50Hz, 60Hz	-	1336004700
	Screw	AC110V, 120V	50Hz, 60Hz	-	1336004800
	Screw	AC200V, 220V	50Hz, 60Hz	-	1336004900
	Screw	AC240V, 277V	50Hz, 60Hz	-	1336005000
Screw	DC12V	-	-	1336005100	
Screw	DC20V	-	-	1336005200	
Screw	DC24V	-	-	1336005300	
Screw	DC48V	-	-	1336005400	
Screw	DC60V	-	-	1336005500	
Screw	DC80V	-	-	1336005600	
Screw	DC100V	-	-	1336005700	
Screw	DC110V	-	-	1336005800	
Screw	DC125V	-	-	1336005900	
Screw	DC200V	-	-	1336006000	
Screw	DC250V	-	-	1336006100	
Screw	DC220V	-	-	1336006200	

Contactors

MC-32a screw only type



40AF

Model	Terminal type	Coil Voltage	Frequency	Aux. Contact	Code
MC-32a	Screw	AC24V	50/60Hz	1a1b	1336006300
	Screw	AC48V	50/60Hz	1a1b	1336006400
	Screw	AC100V	50/60Hz	1a1b	1336006500
	Screw	AC110V	50/60Hz	1a1b	1336006600
	Screw	AC120V	50/60Hz	1a1b	1336006700
	Screw	AC200V	50/60Hz	1a1b	1336006800
	Screw	AC220V	50/60Hz	1a1b	1336006900
	Screw	AC230V	50/60Hz	1a1b	1336007000
	Screw	AC240V	50/60Hz	1a1b	1336007100
	Screw	AC380V	50/60Hz	1a1b	1336007200
	Screw	AC400V	50/60Hz	1a1b	1336007300
	Screw	AC415V	50/60Hz	1a1b	1336007400
	Screw	AC440V	50/60Hz	1a1b	1336007500
	Screw	AC500V	50/60Hz	1a1b	1336007600
	Screw	AC550V	50/60Hz	1a1b	1336007700
	Screw	AC24V	50Hz	1a1b	1336007800
	Screw	AC36V	50Hz	1a1b	1336007900
	Screw	AC42V	50Hz	1a1b	1336008000
	Screw	AC48V	50Hz	1a1b	1336008100
	Screw	AC80V	50Hz	1a1b	1336008200
	Screw	AC100V	50Hz	1a1b	1336008300
	Screw	AC110V	50Hz	1a1b	1336008400
	Screw	AC220V	50Hz	1a1b	1336008500
	Screw	AC230V	50Hz	1a1b	1336008600
	Screw	AC240V	50Hz	1a1b	1336008700
	Screw	AC380V	50Hz	1a1b	1336008800
	Screw	AC400V	50Hz	1a1b	1336008900
	Screw	AC415V	50Hz	1a1b	1336009000
	Screw	AC440V	50Hz	1a1b	1336009100
	Screw	AC500V	50Hz	1a1b	1336009200
	Screw	AC550V	50Hz	1a1b	1336009300
	Screw	AC24V	60Hz	1a1b	1336009400
	Screw	AC48V	60Hz	1a1b	1336009500
	Screw	AC100V	60Hz	1a1b	1336009600
	Screw	AC110V	60Hz	1a1b	1336009700
	Screw	AC120V	60Hz	1a1b	1336009800
	Screw	AC200V	60Hz	1a1b	1336009900
	Screw	AC208V	60Hz	1a1b	1336010000
	Screw	AC220V	60Hz	1a1b	1336010100
	Screw	AC230V	60Hz	1a1b	1336010200
	Screw	AC240V	60Hz	1a1b	1336010300
	Screw	AC277V	60Hz	1a1b	1336010400
Screw	AC380V	60Hz	1a1b	1336010500	
Screw	AC440V	60Hz	1a1b	1336010600	
Screw	AC480V	60Hz	1a1b	1336010700	
Screw	AC600V	60Hz	1a1b	1336010800	
Screw	AC100V, 110V	50Hz, 60Hz	1a1b	1336010900	
Screw	AC110V, 120V	50Hz, 60Hz	1a1b	1336011000	
Screw	AC200V, 220V	50Hz, 60Hz	1a1b	1336011100	
Screw	AC240V, 277V	50Hz, 60Hz	1a1b	1336011200	
Screw	DC12V	-	1a1b	1336011300	
Screw	DC20V	-	1a1b	1336011400	
Screw	DC24V	-	1a1b	1336011500	
Screw	DC48V	-	1a1b	1336011600	
Screw	DC60V	-	1a1b	1336011700	
Screw	DC80V	-	1a1b	1336011800	
Screw	DC100V	-	1a1b	1336011900	
Screw	DC110V	-	1a1b	1336012000	
Screw	DC125V	-	1a1b	1336012100	
Screw	DC200V	-	1a1b	1336012200	
Screw	DC220V	-	1a1b	1336012300	
Screw	DC250V	-	1a1b	1336012400	

Contactors

MC-32a screw only type



40AF

Model	Terminal type	Coil Voltage	Frequency	Aux. Contact	Code
MC-32a	Screw	AC24V	50/60Hz	2a2b	1336012500
	Screw	AC48V	50/60Hz	2a2b	1336012600
	Screw	AC100V	50/60Hz	2a2b	1336012700
	Screw	AC110V	50/60Hz	2a2b	1336012800
	Screw	AC120V	50/60Hz	2a2b	1336012900
	Screw	AC200V	50/60Hz	2a2b	1336013000
	Screw	AC220V	50/60Hz	2a2b	1336013100
	Screw	AC230V	50/60Hz	2a2b	1336013200
	Screw	AC240V	50/60Hz	2a2b	1336013300
	Screw	AC380V	50/60Hz	2a2b	1336013400
	Screw	AC400V	50/60Hz	2a2b	1336013500
	Screw	AC415V	50/60Hz	2a2b	1336013600
	Screw	AC440V	50/60Hz	2a2b	1336013700
	Screw	AC500V	50/60Hz	2a2b	1336013800
	Screw	AC550V	50/60Hz	2a2b	1336013900
	Screw	AC24V	50Hz	2a2b	1336014000
	Screw	AC36V	50Hz	2a2b	1336014100
	Screw	AC42V	50Hz	2a2b	1336014200
	Screw	AC48V	50Hz	2a2b	1336014300
	Screw	AC80V	50Hz	2a2b	1336014400
	Screw	AC100V	50Hz	2a2b	1336014500
	Screw	AC110V	50Hz	2a2b	1336014600
	Screw	AC220V	50Hz	2a2b	1336014700
	Screw	AC230V	50Hz	2a2b	1336014800
	Screw	AC240V	50Hz	2a2b	1336014900
	Screw	AC380V	50Hz	2a2b	1336015000
	Screw	AC400V	50Hz	2a2b	1336015100
	Screw	AC415V	50Hz	2a2b	1336015200
	Screw	AC440V	50Hz	2a2b	1336015300
	Screw	AC500V	50Hz	2a2b	1336015400
	Screw	AC550V	50Hz	2a2b	1336015500
	Screw	AC24V	60Hz	2a2b	1336015600
	Screw	AC48V	60Hz	2a2b	1336015700
	Screw	AC100V	60Hz	2a2b	1336015800
	Screw	AC110V	60Hz	2a2b	1336015900
	Screw	AC120V	60Hz	2a2b	1336016000
	Screw	AC200V	60Hz	2a2b	1336016100
	Screw	AC208V	60Hz	2a2b	1336016200
	Screw	AC220V	60Hz	2a2b	1336016300
	Screw	AC230V	60Hz	2a2b	1336016400
	Screw	AC240V	60Hz	2a2b	1336016500
	Screw	AC277V	60Hz	2a2b	1336016600
	Screw	AC380V	60Hz	2a2b	1336016700
	Screw	AC440V	60Hz	2a2b	1336016800
	Screw	AC480V	60Hz	2a2b	1336016900
Screw	AC600V	60Hz	2a2b	1336017000	
Screw	AC100V, 110V	50Hz, 60Hz	2a2b	1336017100	
Screw	AC110V, 120V	50Hz, 60Hz	2a2b	1336017200	
Screw	AC200V, 220V	50Hz, 60Hz	2a2b	1336017300	
Screw	AC240V, 277V	50Hz, 60Hz	2a2b	1336017400	
Screw	DC12V	-	2a2b	1336017500	
Screw	DC20V	-	2a2b	1336017600	
Screw	DC24V	-	2a2b	1336017700	
Screw	DC48V	-	2a2b	1336017800	
Screw	DC60V	-	2a2b	1336017900	
Screw	DC80V	-	2a2b	1336018000	
Screw	DC100V	-	2a2b	1336018100	
Screw	DC110V	-	2a2b	1336018200	
Screw	DC125V	-	2a2b	1336018300	
Screw	DC200V	-	2a2b	1336018400	
Screw	DC220V	-	2a2b	1336018500	
Screw	DC250V	-	2a2b	1336018600	

Contactors

MC-40a screw only type



40AF

Model	Terminal type	Coil Voltage	Frequency	Aux. Contact	Code
MC-40a	Screw	AC24V	50/60Hz	-	1337000100
	Screw	AC48V	50/60Hz	-	1337000200
	Screw	AC100V	50/60Hz	-	1337000300
	Screw	AC110V	50/60Hz	-	1337000400
	Screw	AC120V	50/60Hz	-	1337000500
	Screw	AC200V	50/60Hz	-	1337000600
	Screw	AC220V	50/60Hz	-	1337000700
	Screw	AC230V	50/60Hz	-	1337000800
	Screw	AC240V	50/60Hz	-	1337000900
	Screw	AC380V	50/60Hz	-	1337001000
	Screw	AC400V	50/60Hz	-	1337001100
	Screw	AC415V	50/60Hz	-	1337001200
	Screw	AC440V	50/60Hz	-	1337001300
	Screw	AC500V	50/60Hz	-	1337001400
	Screw	AC550V	50/60Hz	-	1337001500
	Screw	AC24V	50Hz	-	1337001600
	Screw	AC32V	50Hz	-	1337018700
	Screw	AC36V	50Hz	-	1337001700
	Screw	AC42V	50Hz	-	1337001800
	Screw	AC48V	50Hz	-	1337001900
	Screw	AC80V	50Hz	-	1337002000
	Screw	AC100V	50Hz	-	1337002100
	Screw	AC110V	50Hz	-	1337002200
	Screw	AC220V	50Hz	-	1337002300
	Screw	AC230V	50Hz	-	1337002400
	Screw	AC240V	50Hz	-	1337002500
	Screw	AC380V	50Hz	-	1337002600
	Screw	AC400V	50Hz	-	1337002700
	Screw	AC415V	50Hz	-	1337002800
	Screw	AC440V	50Hz	-	1337002900
	Screw	AC500V	50Hz	-	1337003000
	Screw	AC550V	50Hz	-	1337003100
	Screw	AC24V	60Hz	-	1337003200
	Screw	AC48V	60Hz	-	1337003300
	Screw	AC100V	60Hz	-	1337003400
	Screw	AC110V	60Hz	-	1337003500
	Screw	AC120V	60Hz	-	1337003600
	Screw	AC200V	60Hz	-	1337003700
	Screw	AC208V	60Hz	-	1337003800
	Screw	AC220V	60Hz	-	1337003900
	Screw	AC230V	60Hz	-	1337004000
	Screw	AC240V	60Hz	-	1337004100
	Screw	AC277V	60Hz	-	1337004200
Screw	AC380V	60Hz	-	1337004300	
Screw	AC440V	60Hz	-	1337004400	
Screw	AC480V	60Hz	-	1337004500	
Screw	AC600V	60Hz	-	1337004600	
Screw	AC100V, 110V	50Hz, 60Hz	-	1337004700	
Screw	AC110V, 120V	50Hz, 60Hz	-	1337004800	
Screw	AC200V, 220V	50Hz, 60Hz	-	1337004900	
Screw	AC240V, 277V	50Hz, 60Hz	-	1337005000	
Screw	DC12V	-	-	1337005100	
Screw	DC20V	-	-	1337005200	
Screw	DC24V	-	-	1337005300	
Screw	DC48V	-	-	1337005400	
Screw	DC60V	-	-	1337005500	
Screw	DC80V	-	-	1337005600	
Screw	DC100V	-	-	1337005700	
Screw	DC110V	-	-	1337005800	
Screw	DC125V	-	-	1337005900	
Screw	DC200V	-	-	1337006000	
Screw	DC250V	-	-	1337006100	
Screw	DC220V	-	-	1337006200	

Contactors

MC-40a screw only type



40AF

Model	Terminal type	Coil Voltage	Frequency	Aux. Contact	Code
MC-40a	Screw	AC24V	50/60Hz	1a1b	1337006300
	Screw	AC48V	50/60Hz	1a1b	1337006400
	Screw	AC100V	50/60Hz	1a1b	1337006500
	Screw	AC110V	50/60Hz	1a1b	1337006600
	Screw	AC120V	50/60Hz	1a1b	1337006700
	Screw	AC200V	50/60Hz	1a1b	1337006800
	Screw	AC220V	50/60Hz	1a1b	1337006900
	Screw	AC230V	50/60Hz	1a1b	1337007000
	Screw	AC240V	50/60Hz	1a1b	1337007100
	Screw	AC380V	50/60Hz	1a1b	1337007200
	Screw	AC400V	50/60Hz	1a1b	1337007300
	Screw	AC415V	50/60Hz	1a1b	1337007400
	Screw	AC440V	50/60Hz	1a1b	1337007500
	Screw	AC500V	50/60Hz	1a1b	1337007600
	Screw	AC550V	50/60Hz	1a1b	1337007700
	Screw	AC24V	50Hz	1a1b	1337007800
	Screw	AC32V	50Hz	1a1b	1337018800
	Screw	AC36V	50Hz	1a1b	1337007900
	Screw	AC42V	50Hz	1a1b	1337008000
	Screw	AC48V	50Hz	1a1b	1337008100
	Screw	AC80V	50Hz	1a1b	1337008200
	Screw	AC100V	50Hz	1a1b	1337008300
	Screw	AC110V	50Hz	1a1b	1337008400
	Screw	AC220V	50Hz	1a1b	1337008500
	Screw	AC230V	50Hz	1a1b	1337008600
	Screw	AC240V	50Hz	1a1b	1337008700
	Screw	AC380V	50Hz	1a1b	1337008800
	Screw	AC400V	50Hz	1a1b	1337008900
	Screw	AC415V	50Hz	1a1b	1337009000
	Screw	AC440V	50Hz	1a1b	1337009100
	Screw	AC500V	50Hz	1a1b	1337009200
	Screw	AC550V	50Hz	1a1b	1337009300
	Screw	AC24V	60Hz	1a1b	1337009400
	Screw	AC48V	60Hz	1a1b	1337009500
	Screw	AC100V	60Hz	1a1b	1337009600
	Screw	AC110V	60Hz	1a1b	1337009700
	Screw	AC120V	60Hz	1a1b	1337009800
	Screw	AC200V	60Hz	1a1b	1337009900
	Screw	AC208V	60Hz	1a1b	1337010000
	Screw	AC220V	60Hz	1a1b	1337010100
	Screw	AC230V	60Hz	1a1b	1337010200
	Screw	AC240V	60Hz	1a1b	1337010300
Screw	AC277V	60Hz	1a1b	1337010400	
Screw	AC380V	60Hz	1a1b	1337010500	
Screw	AC440V	60Hz	1a1b	1337010600	
Screw	AC480V	60Hz	1a1b	1337010700	
Screw	AC600V	60Hz	1a1b	1337010800	
Screw	AC100V, 110V	50Hz, 60Hz	1a1b	1337010900	
Screw	AC110V, 120V	50Hz, 60Hz	1a1b	1337011000	
Screw	AC200V, 220V	50Hz, 60Hz	1a1b	1337011100	
Screw	AC240V, 277V	50Hz, 60Hz	1a1b	1337011200	
Screw	DC12V	-	1a1b	1337011300	
Screw	DC20V	-	1a1b	1337011400	
Screw	DC24V	-	1a1b	1337011500	
Screw	DC48V	-	1a1b	1337011600	
Screw	DC60V	-	1a1b	1337011700	
Screw	DC80V	-	1a1b	1337011800	
Screw	DC100V	-	1a1b	1337011900	
Screw	DC110V	-	1a1b	1337012000	
Screw	DC125V	-	1a1b	1337012100	
Screw	DC200V	-	1a1b	1337012200	
Screw	DC220V	-	1a1b	1337012300	
Screw	DC250V	-	1a1b	1337012400	

Contactors

MC-40a screw only type



40AF

Model	Terminal type	Coil Voltage	Frequency	Aux. Contact	Code
MC-40a	Screw	AC24V	50/60Hz	2a2b	1337012500
	Screw	AC48V	50/60Hz	2a2b	1337012600
	Screw	AC100V	50/60Hz	2a2b	1337012700
	Screw	AC110V	50/60Hz	2a2b	1337012800
	Screw	AC120V	50/60Hz	2a2b	1337012900
	Screw	AC200V	50/60Hz	2a2b	1337013000
	Screw	AC220V	50/60Hz	2a2b	1337013100
	Screw	AC230V	50/60Hz	2a2b	1337013200
	Screw	AC240V	50/60Hz	2a2b	1337013300
	Screw	AC380V	50/60Hz	2a2b	1337013400
	Screw	AC400V	50/60Hz	2a2b	1337013500
	Screw	AC415V	50/60Hz	2a2b	1337013600
	Screw	AC440V	50/60Hz	2a2b	1337013700
	Screw	AC500V	50/60Hz	2a2b	1337013800
	Screw	AC550V	50/60Hz	2a2b	1337013900
	Screw	AC24V	50Hz	2a2b	1337014000
	Screw	AC32V	50Hz	2a2b	1337018900
	Screw	AC36V	50Hz	2a2b	1337014100
	Screw	AC42V	50Hz	2a2b	1337014200
	Screw	AC48V	50Hz	2a2b	1337014300
	Screw	AC80V	50Hz	2a2b	1337014400
	Screw	AC100V	50Hz	2a2b	1337014500
	Screw	AC110V	50Hz	2a2b	1337014600
	Screw	AC220V	50Hz	2a2b	1337014700
	Screw	AC230V	50Hz	2a2b	1337014800
	Screw	AC240V	50Hz	2a2b	1337014900
	Screw	AC380V	50Hz	2a2b	1337015000
	Screw	AC400V	50Hz	2a2b	1337015100
	Screw	AC415V	50Hz	2a2b	1337015200
	Screw	AC440V	50Hz	2a2b	1337015300
	Screw	AC500V	50Hz	2a2b	1337015400
	Screw	AC550V	50Hz	2a2b	1337015500
	Screw	AC24V	60Hz	2a2b	1337015600
	Screw	AC48V	60Hz	2a2b	1337015700
	Screw	AC100V	60Hz	2a2b	1337015800
	Screw	AC110V	60Hz	2a2b	1337015900
	Screw	AC120V	60Hz	2a2b	1337016000
	Screw	AC200V	60Hz	2a2b	1337016100
	Screw	AC208V	60Hz	2a2b	1337016200
	Screw	AC220V	60Hz	2a2b	1337016300
	Screw	AC230V	60Hz	2a2b	1337016400
	Screw	AC240V	60Hz	2a2b	1337016500
	Screw	AC277V	60Hz	2a2b	1337016600
	Screw	AC380V	60Hz	2a2b	1337016700
	Screw	AC440V	60Hz	2a2b	1337016800
Screw	AC480V	60Hz	2a2b	1337016900	
Screw	AC600V	60Hz	2a2b	1337017000	
Screw	AC100V, 110V	50Hz, 60Hz	2a2b	1337017100	
Screw	AC110V, 120V	50Hz, 60Hz	2a2b	1337017200	
Screw	AC200V, 220V	50Hz, 60Hz	2a2b	1337017300	
Screw	AC240V, 277V	50Hz, 60Hz	2a2b	1337017400	
Screw	DC12V	-	2a2b	1337017500	
Screw	DC20V	-	2a2b	1337017600	
Screw	DC24V	-	2a2b	1337017700	
Screw	DC48V	-	2a2b	1337017800	
Screw	DC60V	-	2a2b	1337017900	
Screw	DC80V	-	2a2b	1337018000	
Screw	DC100V	-	2a2b	1337018100	
Screw	DC110V	-	2a2b	1337018200	
Screw	DC125V	-	2a2b	1337018300	
Screw	DC200V	-	2a2b	1337018400	
Screw	DC220V	-	2a2b	1337018500	
Screw	DC250V	-	2a2b	1337018600	

Contactors

MC-50a screw only type



65AF

Model	Terminal type	Coil Voltage	Frequency	Aux. Contact	Code
MC-50a	Screw	AC24V	50/60Hz	-	1338000100
	Screw	AC48V	50/60Hz	-	1338000200
	Screw	AC100V	50/60Hz	-	1338000300
	Screw	AC110V	50/60Hz	-	1338000400
	Screw	AC120V	50/60Hz	-	1338000500
	Screw	AC200V	50/60Hz	-	1338000600
	Screw	AC220V	50/60Hz	-	1338000700
	Screw	AC230V	50/60Hz	-	1338000800
	Screw	AC240V	50/60Hz	-	1338018700
	Screw	AC380V	50/60Hz	-	1338001000
	Screw	AC500V	50/60Hz	-	1338001100
	Screw	AC415V	50/60Hz	-	1338001200
	Screw	AC440V	50/60Hz	-	1338001300
	Screw	AC400V	50/60Hz	-	1338018800
	Screw	AC550V	50/60Hz	-	1338001500
	Screw	AC24V	50Hz	-	1338001600
	Screw	AC36V	50Hz	-	1338001700
	Screw	AC42V	50Hz	-	1338001800
	Screw	AC48V	50Hz	-	1338001900
	Screw	AC80V	50Hz	-	1338002000
	Screw	AC100V	50Hz	-	1338002100
	Screw	AC110V	50Hz	-	1338002200
	Screw	AC220V	50Hz	-	1338002300
	Screw	AC230V	50Hz	-	1338002400
	Screw	AC240V	50Hz	-	1338002500
	Screw	AC380V	50Hz	-	1338002600
	Screw	AC500V	50Hz	-	1338002700
	Screw	AC415V	50Hz	-	1338002800
	Screw	AC440V	50Hz	-	1338002900
	Screw	AC400V	50Hz	-	1338018900
	Screw	AC550V	50Hz	-	1338003100
	Screw	AC24V	60Hz	-	1338003200
	Screw	AC48V	60Hz	-	1338003300
	Screw	AC100V	60Hz	-	1338003400
	Screw	AC110V	60Hz	-	1338003500
	Screw	AC120V	60Hz	-	1338003600
	Screw	AC200V	60Hz	-	1338003700
	Screw	AC208V	60Hz	-	1338003800
	Screw	AC220V	60Hz	-	1338003900
	Screw	AC230V	60Hz	-	1338004000
	Screw	AC240V	60Hz	-	1338004100
	Screw	AC277V	60Hz	-	1338004200
	Screw	AC380V	60Hz	-	1338004300
	Screw	AC440V	60Hz	-	1338004400
	Screw	AC480V	60Hz	-	1338004500
	Screw	AC600V	60Hz	-	1338004600
	Screw	AC100V, 110V	50Hz, 60Hz	-	1338004700
	Screw	AC110V, 120V	50Hz, 60Hz	-	1338004800
	Screw	AC200V, 220V	50Hz, 60Hz	-	1338004900
	Screw	AC240V, 277V	50Hz, 60Hz	-	1338005000
Screw	DC12V	-	-	1338005100	
Screw	DC20V	-	-	1338005200	
Screw	DC24V	-	-	1338005300	
Screw	DC48V	-	-	1338005400	
Screw	DC60V	-	-	1338005500	
Screw	DC80V	-	-	1338005600	
Screw	DC100V	-	-	1338005700	
Screw	DC110V	-	-	1338005800	
Screw	DC125V	-	-	1338005900	
Screw	DC200V	-	-	1338006000	
Screw	DC250V	-	-	1338006100	
Screw	DC220V	-	-	1338006200	

Contactors

MC-50a screw only type



65AF

Model	Terminal type	Coil Voltage	Frequency	Aux. Contact	Code
MC-50a	Screw	AC24V	50/60Hz	1a1b	1338006300
	Screw	AC48V	50/60Hz	1a1b	1338006400
	Screw	AC100V	50/60Hz	1a1b	1338006500
	Screw	AC110V	50/60Hz	1a1b	1338006600
	Screw	AC120V	50/60Hz	1a1b	1338006700
	Screw	AC200V	50/60Hz	1a1b	1338006800
	Screw	AC220V	50/60Hz	1a1b	1338006900
	Screw	AC230V	50/60Hz	1a1b	1338007000
	Screw	AC240V	50/60Hz	1a1b	1338007100
	Screw	AC380V	50/60Hz	1a1b	1338007200
	Screw	AC500V	50/60Hz	1a1b	1338007300
	Screw	AC415V	50/60Hz	1a1b	1338007400
	Screw	AC440V	50/60Hz	1a1b	1338007500
	Screw	AC400V	50/60Hz	1a1b	1338019000
	Screw	AC550V	50/60Hz	1a1b	1338007700
	Screw	AC24V	50Hz	1a1b	1338007800
	Screw	AC36V	50Hz	1a1b	1338007900
	Screw	AC42V	50Hz	1a1b	1338008000
	Screw	AC48V	50Hz	1a1b	1338008100
	Screw	AC80V	50Hz	1a1b	1338008200
	Screw	AC100V	50Hz	1a1b	1338008300
	Screw	AC110V	50Hz	1a1b	1338008400
	Screw	AC220V	50Hz	1a1b	1338008500
	Screw	AC230V	50Hz	1a1b	1338008600
	Screw	AC240V	50Hz	1a1b	1338008700
	Screw	AC380V	50Hz	1a1b	1338008800
	Screw	AC500V	50Hz	1a1b	1338008900
	Screw	AC415V	50Hz	1a1b	1338009000
	Screw	AC440V	50Hz	1a1b	1338009100
	Screw	AC400V	50Hz	1a1b	1338019100
	Screw	AC550V	50Hz	1a1b	1338009300
	Screw	AC24V	60Hz	1a1b	1338009400
	Screw	AC48V	60Hz	1a1b	1338009500
	Screw	AC100V	60Hz	1a1b	1338009600
	Screw	AC110V	60Hz	1a1b	1338009700
	Screw	AC120V	60Hz	1a1b	1338009800
	Screw	AC200V	60Hz	1a1b	1338009900
	Screw	AC208V	60Hz	1a1b	1338010000
	Screw	AC220V	60Hz	1a1b	1338010100
	Screw	AC230V	60Hz	1a1b	1338010200
	Screw	AC240V	60Hz	1a1b	1338010300
	Screw	AC277V	60Hz	1a1b	1338010400
	Screw	AC380V	60Hz	1a1b	1338010500
	Screw	AC440V	60Hz	1a1b	1338010600
	Screw	AC480V	60Hz	1a1b	1338010700
Screw	AC600V	60Hz	1a1b	1338010800	
Screw	AC100V, 110V	50Hz, 60Hz	1a1b	1338010900	
Screw	AC110V, 120V	50Hz, 60Hz	1a1b	1338011000	
Screw	AC200V, 220V	50Hz, 60Hz	1a1b	1338011100	
Screw	AC240V, 277V	50Hz, 60Hz	1a1b	1338011200	
Screw	DC12V	-	1a1b	1338011300	
Screw	DC20V	-	1a1b	1338011400	
Screw	DC24V	-	1a1b	1338011500	
Screw	DC48V	-	1a1b	1338011600	
Screw	DC60V	-	1a1b	1338011700	
Screw	DC80V	-	1a1b	1338011800	
Screw	DC100V	-	1a1b	1338011900	
Screw	DC110V	-	1a1b	1338012000	
Screw	DC125V	-	1a1b	1338012100	
Screw	DC200V	-	1a1b	1338012200	
Screw	DC220V	-	1a1b	1338012300	
Screw	DC250V	-	1a1b	1338012400	

Contactors

MC-50a screw only type



65AF

Model	Terminal type	Coil Voltage	Frequency	Aux. Contact	Code
MC-50a	Screw	AC24V	50/60Hz	2a2b	1338012500
	Screw	AC48V	50/60Hz	2a2b	1338012600
	Screw	AC100V	50/60Hz	2a2b	1338012700
	Screw	AC110V	50/60Hz	2a2b	1338012800
	Screw	AC120V	50/60Hz	2a2b	1338012900
	Screw	AC200V	50/60Hz	2a2b	1338013000
	Screw	AC220V	50/60Hz	2a2b	1338013100
	Screw	AC230V	50/60Hz	2a2b	1338013200
	Screw	AC240V	50/60Hz	2a2b	1338013300
	Screw	AC380V	50/60Hz	2a2b	1338013400
	Screw	AC500V	50/60Hz	2a2b	1338013500
	Screw	AC415V	50/60Hz	2a2b	1338013600
	Screw	AC440V	50/60Hz	2a2b	1338013700
	Screw	AC400V	50/60Hz	2a2b	1338019200
	Screw	AC550V	50/60Hz	2a2b	1338013900
	Screw	AC24V	50Hz	2a2b	1338014000
	Screw	AC36V	50Hz	2a2b	1338014100
	Screw	AC42V	50Hz	2a2b	1338014200
	Screw	AC48V	50Hz	2a2b	1338014300
	Screw	AC80V	50Hz	2a2b	1338014400
	Screw	AC100V	50Hz	2a2b	1338014500
	Screw	AC110V	50Hz	2a2b	1338014600
	Screw	AC220V	50Hz	2a2b	1338014700
	Screw	AC230V	50Hz	2a2b	1338014800
	Screw	AC240V	50Hz	2a2b	1338014900
	Screw	AC380V	50Hz	2a2b	1338015000
	Screw	AC500V	50Hz	2a2b	1338015100
	Screw	AC415V	50Hz	2a2b	1338015200
	Screw	AC440V	50Hz	2a2b	1338015300
	Screw	AC400V	50Hz	2a2b	1338019300
	Screw	AC550V	50Hz	2a2b	1338015500
	Screw	AC24V	60Hz	2a2b	1338015600
	Screw	AC48V	60Hz	2a2b	1338015700
	Screw	AC100V	60Hz	2a2b	1338015800
	Screw	AC110V	60Hz	2a2b	1338015900
	Screw	AC120V	60Hz	2a2b	1338016000
	Screw	AC200V	60Hz	2a2b	1338016100
	Screw	AC208V	60Hz	2a2b	1338016200
	Screw	AC220V	60Hz	2a2b	1338016300
	Screw	AC230V	60Hz	2a2b	1338016400
	Screw	AC240V	60Hz	2a2b	1338016500
	Screw	AC277V	60Hz	2a2b	1338016600
	Screw	AC380V	60Hz	2a2b	1338016700
	Screw	AC440V	60Hz	2a2b	1338016800
	Screw	AC480V	60Hz	2a2b	1338016900
	Screw	AC600V	60Hz	2a2b	1338017000
	Screw	AC100V, 110V	50Hz, 60Hz	2a2b	1338017100
	Screw	AC110V, 120V	50Hz, 60Hz	2a2b	1338017200
	Screw	AC200V, 220V	50Hz, 60Hz	2a2b	1338017300
	Screw	AC240V, 277V	50Hz, 60Hz	2a2b	1338017400
Screw	DC12V	-	2a2b	1338017500	
Screw	DC20V	-	2a2b	1338017600	
Screw	DC24V	-	2a2b	1338017700	
Screw	DC48V	-	2a2b	1338017800	
Screw	DC60V	-	2a2b	1338017900	
Screw	DC80V	-	2a2b	1338018000	
Screw	DC100V	-	2a2b	1338018100	
Screw	DC110V	-	2a2b	1338018200	
Screw	DC125V	-	2a2b	1338018300	
Screw	DC200V	-	2a2b	1338018400	
Screw	DC220V	-	2a2b	1338018500	
Screw	DC250V	-	2a2b	1338018600	

Contactors

MC-65a screw only type



65AF

Model	Terminal type	Coil Voltage	Frequency	Aux. Contact	Code
MC-65a	Screw	AC24V	50/60Hz	-	1339000100
	Screw	AC48V	50/60Hz	-	1339000200
	Screw	AC100V	50/60Hz	-	1339000300
	Screw	AC110V	50/60Hz	-	1339000400
	Screw	AC120V	50/60Hz	-	1339000500
	Screw	AC200V	50/60Hz	-	1339000600
	Screw	AC220V	50/60Hz	-	1339000700
	Screw	AC230V	50/60Hz	-	1339000800
	Screw	AC240V	50/60Hz	-	1339019000
	Screw	AC380V	50/60Hz	-	1339001000
	Screw	AC400V	50/60Hz	-	1339001100
	Screw	AC415V	50/60Hz	-	1339001200
	Screw	AC440V	50/60Hz	-	1339001300
	Screw	AC500V	50/60Hz	-	1339001400
	Screw	AC550V	50/60Hz	-	1339001500
	Screw	AC24V	50Hz	-	1339001600
	Screw	AC36V	50Hz	-	1339001700
	Screw	AC42V	50Hz	-	1339001800
	Screw	AC48V	50Hz	-	1339001900
	Screw	AC80V	50Hz	-	1339002000
	Screw	AC100V	50Hz	-	1339002100
	Screw	AC110V	50Hz	-	1339002200
	Screw	AC220V	50Hz	-	1339002300
	Screw	AC230V	50Hz	-	1339002400
	Screw	AC240V	50Hz	-	1339002500
	Screw	AC380V	50Hz	-	1339002600
	Screw	AC400V	50Hz	-	1339002700
	Screw	AC415V	50Hz	-	1339002800
	Screw	AC440V	50Hz	-	1339002900
	Screw	AC500V	50Hz	-	1339003000
	Screw	AC550V	50Hz	-	1339003100
	Screw	AC24V	60Hz	-	1339003200
	Screw	AC48V	60Hz	-	1339003300
	Screw	AC100V	60Hz	-	1339003400
	Screw	AC110V	60Hz	-	1339003500
	Screw	AC120V	60Hz	-	1339003600
	Screw	AC200V	60Hz	-	1339003700
	Screw	AC208V	60Hz	-	1339003800
	Screw	AC220V	60Hz	-	1339003900
	Screw	AC230V	60Hz	-	1339004000
	Screw	AC240V	60Hz	-	1339004100
	Screw	AC277V	60Hz	-	1339004200
	Screw	AC380V	60Hz	-	1339004300
	Screw	AC440V	60Hz	-	1339004400
	Screw	AC480V	60Hz	-	1339004500
Screw	AC600V	60Hz	-	1339004600	
Screw	AC100V, 110V	50Hz, 60Hz	-	1339004700	
Screw	AC110V, 120V	50Hz, 60Hz	-	1339004800	
Screw	AC200V, 220V	50Hz, 60Hz	-	1339004900	
Screw	AC240V, 277V	50Hz, 60Hz	-	1339005000	
Screw	DC12V	-	-	1339005100	
Screw	DC20V	-	-	1339005200	
Screw	DC24V	-	-	1339005300	
Screw	DC48V	-	-	1339005400	
Screw	DC60V	-	-	1339005500	
Screw	DC80V	-	-	1339005600	
Screw	DC100V	-	-	1339005700	
Screw	DC110V	-	-	1339005800	
Screw	DC125V	-	-	1339005900	
Screw	DC200V	-	-	1339006000	
Screw	DC250V	-	-	1339006100	
Screw	DC220V	-	-	1339006200	

Contactors

MC-65a screw only type



65AF

Model	Terminal type	Coil Voltage	Frequency	Aux. Contact	Code
MC-65a	Screw	AC24V	50/60Hz	1a1b	1339006300
	Screw	AC48V	50/60Hz	1a1b	1339006400
	Screw	AC100V	50/60Hz	1a1b	1339006500
	Screw	AC110V	50/60Hz	1a1b	1339006600
	Screw	AC120V	50/60Hz	1a1b	1339006700
	Screw	AC200V	50/60Hz	1a1b	1339006800
	Screw	AC220V	50/60Hz	1a1b	1339006900
	Screw	AC230V	50/60Hz	1a1b	1339007000
	Screw	AC240V	50/60Hz	1a1b	1339007100
	Screw	AC380V	50/60Hz	1a1b	1339007200
	Screw	AC400V	50/60Hz	1a1b	1339007300
	Screw	AC415V	50/60Hz	1a1b	1339007400
	Screw	AC440V	50/60Hz	1a1b	1339007500
	Screw	AC500V	50/60Hz	1a1b	1339007600
	Screw	AC550V	50/60Hz	1a1b	1339007700
	Screw	AC24V	50Hz	1a1b	1339007800
	Screw	AC36V	50Hz	1a1b	1339007900
	Screw	AC42V	50Hz	1a1b	1339008000
	Screw	AC48V	50Hz	1a1b	1339008100
	Screw	AC80V	50Hz	1a1b	1339008200
	Screw	AC100V	50Hz	1a1b	1339008300
	Screw	AC110V	50Hz	1a1b	1339008400
	Screw	AC220V	50Hz	1a1b	1339008500
	Screw	AC230V	50Hz	1a1b	1339008600
	Screw	AC240V	50Hz	1a1b	1339008700
	Screw	AC380V	50Hz	1a1b	1339008800
	Screw	AC400V	50Hz	1a1b	1339008900
	Screw	AC415V	50Hz	1a1b	1339009000
	Screw	AC440V	50Hz	1a1b	1339009100
	Screw	AC500V	50Hz	1a1b	1339009200
	Screw	AC550V	50Hz	1a1b	1339009300
	Screw	AC24V	60Hz	1a1b	1339009400
	Screw	AC48V	60Hz	1a1b	1339009500
	Screw	AC100V	60Hz	1a1b	1339009600
	Screw	AC110V	60Hz	1a1b	1339009700
	Screw	AC120V	60Hz	1a1b	1339009800
	Screw	AC200V	60Hz	1a1b	1339009900
	Screw	AC208V	60Hz	1a1b	1339010000
	Screw	AC220V	60Hz	1a1b	1339010100
	Screw	AC230V	60Hz	1a1b	1339010200
	Screw	AC240V	60Hz	1a1b	1339010300
	Screw	AC277V	60Hz	1a1b	1339010400
	Screw	AC380V	60Hz	1a1b	1339010500
	Screw	AC440V	60Hz	1a1b	1339010600
	Screw	AC480V	60Hz	1a1b	1339010700
Screw	AC600V	60Hz	1a1b	1339010800	
Screw	AC100V, 110V	50Hz, 60Hz	1a1b	1339010900	
Screw	AC110V, 120V	50Hz, 60Hz	1a1b	1339011000	
Screw	AC200V, 220V	50Hz, 60Hz	1a1b	1339011100	
Screw	AC240V, 277V	50Hz, 60Hz	1a1b	1339011200	
Screw	DC12V	-	1a1b	1339011300	
Screw	DC20V	-	1a1b	1339011400	
Screw	DC24V	-	1a1b	1339011500	
Screw	DC48V	-	1a1b	1339011600	
Screw	DC60V	-	1a1b	1339011700	
Screw	DC80V	-	1a1b	1339011800	
Screw	DC100V	-	1a1b	1339011900	
Screw	DC110V	-	1a1b	1339012000	
Screw	DC125V	-	1a1b	1339012100	
Screw	DC200V	-	1a1b	1339012200	
Screw	DC220V	-	1a1b	1339012300	
Screw	DC250V	-	1a1b	1339012400	

Contactors

MC-65a screw only type



65AF

Model	Terminal type	Coil Voltage	Frequency	Aux. Contact	Code
MC-65a	Screw	AC24V	50/60Hz	2a2b	1339012500
	Screw	AC48V	50/60Hz	2a2b	1339012600
	Screw	AC100V	50/60Hz	2a2b	1339012700
	Screw	AC110V	50/60Hz	2a2b	1339012800
	Screw	AC120V	50/60Hz	2a2b	1339012900
	Screw	AC200V	50/60Hz	2a2b	1339013000
	Screw	AC220V	50/60Hz	2a2b	1339013100
	Screw	AC230V	50/60Hz	2a2b	1339013200
	Screw	AC240V	50/60Hz	2a2b	1339013300
	Screw	AC380V	50/60Hz	2a2b	1339013400
	Screw	AC400V	50/60Hz	2a2b	1339013500
	Screw	AC415V	50/60Hz	2a2b	1339013600
	Screw	AC440V	50/60Hz	2a2b	1339013700
	Screw	AC500V	50/60Hz	2a2b	1339013800
	Screw	AC550V	50/60Hz	2a2b	1339013900
	Screw	AC24V	50Hz	2a2b	1339014000
	Screw	AC36V	50Hz	2a2b	1339014100
	Screw	AC42V	50Hz	2a2b	1339014200
	Screw	AC48V	50Hz	2a2b	1339014300
	Screw	AC80V	50Hz	2a2b	1339014400
	Screw	AC100V	50Hz	2a2b	1339014500
	Screw	AC110V	50Hz	2a2b	1339014600
	Screw	AC220V	50Hz	2a2b	1339014700
	Screw	AC230V	50Hz	2a2b	1339014800
	Screw	AC240V	50Hz	2a2b	1339014900
	Screw	AC380V	50Hz	2a2b	1339015000
	Screw	AC400V	50Hz	2a2b	1339015100
	Screw	AC415V	50Hz	2a2b	1339015200
	Screw	AC440V	50Hz	2a2b	1339015300
	Screw	AC500V	50Hz	2a2b	1339015400
	Screw	AC550V	50Hz	2a2b	1339015500
	Screw	AC24V	60Hz	2a2b	1339015600
	Screw	AC48V	60Hz	2a2b	1339015700
	Screw	AC100V	60Hz	2a2b	1339015800
	Screw	AC110V	60Hz	2a2b	1339015900
	Screw	AC120V	60Hz	2a2b	1339016000
	Screw	AC200V	60Hz	2a2b	1339016100
	Screw	AC208V	60Hz	2a2b	1339016200
	Screw	AC220V	60Hz	2a2b	1339016300
	Screw	AC230V	60Hz	2a2b	1339016400
	Screw	AC240V	60Hz	2a2b	1339016500
	Screw	AC277V	60Hz	2a2b	1339016600
	Screw	AC380V	60Hz	2a2b	1339016700
	Screw	AC440V	60Hz	2a2b	1339016800
	Screw	AC480V	60Hz	2a2b	1339016900
Screw	AC600V	60Hz	2a2b	1339017000	
Screw	AC100V, 110V	50Hz, 60Hz	2a2b	1339017100	
Screw	AC110V, 120V	50Hz, 60Hz	2a2b	1339017200	
Screw	AC200V, 220V	50Hz, 60Hz	2a2b	1339017300	
Screw	AC240V, 277V	50Hz, 60Hz	2a2b	1339017400	
Screw	DC12V	-	2a2b	1339017500	
Screw	DC20V	-	2a2b	1339017600	
Screw	DC24V	-	2a2b	1339017700	
Screw	DC48V	-	2a2b	1339017800	
Screw	DC60V	-	2a2b	1339017900	
Screw	DC80V	-	2a2b	1339018000	
Screw	DC100V	-	2a2b	1339018100	
Screw	DC110V	-	2a2b	1339018200	
Screw	DC125V	-	2a2b	1339018300	
Screw	DC200V	-	2a2b	1339018400	
Screw	DC220V	-	2a2b	1339018500	
Screw	DC250V	-	2a2b	1339018600	

Contactors

MC-75a screw only type



100AF

Model	Terminal type	Coil Voltage	Frequency	Aux. Contact	Code
MC-75a	Screw	AC24V	50/60Hz	-	1340000100
	Screw	AC48V	50/60Hz	-	1340000200
	Screw	AC100V	50/60Hz	-	1340000300
	Screw	AC110V	50/60Hz	-	1340000400
	Screw	AC120V	50/60Hz	-	1340000500
	Screw	AC200V	50/60Hz	-	1340000600
	Screw	AC220V	50/60Hz	-	1340000700
	Screw	AC230V	50/60Hz	-	1340000800
	Screw	AC240V	50/60Hz	-	1340019100
	Screw	AC380V	50/60Hz	-	1340001000
	Screw	AC400V	50/60Hz	-	1340019000
	Screw	AC415V	50/60Hz	-	1340001200
	Screw	AC440V	50/60Hz	-	1340001300
	Screw	AC500V	50/60Hz	-	1340001400
	Screw	AC550V	50/60Hz	-	1340001500
	Screw	AC24V	50Hz	-	1340001600
	Screw	AC32V	50Hz	-	1340018700
	Screw	AC36V	50Hz	-	1340001700
	Screw	AC42V	50Hz	-	1340001800
	Screw	AC48V	50Hz	-	1340001900
	Screw	AC80V	50Hz	-	1340002000
	Screw	AC100V	50Hz	-	1340002100
	Screw	AC110V	50Hz	-	1340002200
	Screw	AC220V	50Hz	-	1340002300
	Screw	AC230V	50Hz	-	1340002400
	Screw	AC240V	50Hz	-	1340002500
	Screw	AC380V	50Hz	-	1340002600
	Screw	AC400V	50Hz	-	1340002700
	Screw	AC415V	50Hz	-	1340002800
	Screw	AC440V	50Hz	-	1340002900
	Screw	AC500V	50Hz	-	1340003000
	Screw	AC550V	50Hz	-	1340003100
	Screw	AC24V	60Hz	-	1340003200
	Screw	AC48V	60Hz	-	1340003300
	Screw	AC100V	60Hz	-	1340003400
	Screw	AC110V	60Hz	-	1340003500
	Screw	AC120V	60Hz	-	1340003600
	Screw	AC200V	60Hz	-	1340003700
	Screw	AC208V	60Hz	-	1340003800
	Screw	AC220V	60Hz	-	1340003900
	Screw	AC230V	60Hz	-	1340004000
	Screw	AC240V	60Hz	-	1340004100
	Screw	AC277V	60Hz	-	1340004200
	Screw	AC380V	60Hz	-	1340004300
	Screw	AC440V	60Hz	-	1340004400
	Screw	AC480V	60Hz	-	1340004500
	Screw	AC600V	60Hz	-	1340004600
	Screw	AC100V, 110V	50Hz, 60Hz	-	1340004700
	Screw	AC110V, 120V	50Hz, 60Hz	-	1340004800
	Screw	AC200V, 220V	50Hz, 60Hz	-	1340004900
Screw	AC240V, 277V	50Hz, 60Hz	-	1340005000	
Screw	DC12V	-	-	1340005100	
Screw	DC20V	-	-	1340005200	
Screw	DC24V	-	-	1340005300	
Screw	DC48V	-	-	1340005400	
Screw	DC60V	-	-	1340005500	
Screw	DC80V	-	-	1340005600	
Screw	DC100V	-	-	1340005700	
Screw	DC110V	-	-	1340005800	
Screw	DC125V	-	-	1340005900	
Screw	DC200V	-	-	1340006000	
Screw	DC250V	-	-	1340006100	
Screw	DC220V	-	-	1340006200	

Contactors

MC-75a screw only type



100AF

Model	Terminal type	Coil Voltage	Frequency	Aux. Contact	Code
MC-75a	Screw	AC24V	50/60Hz	1a1b	1340006300
	Screw	AC48V	50/60Hz	1a1b	1340006400
	Screw	AC100V	50/60Hz	1a1b	1340006500
	Screw	AC110V	50/60Hz	1a1b	1340006600
	Screw	AC120V	50/60Hz	1a1b	1340006700
	Screw	AC200V	50/60Hz	1a1b	1340006800
	Screw	AC220V	50/60Hz	1a1b	1340006900
	Screw	AC230V	50/60Hz	1a1b	1340007000
	Screw	AC240V	50/60Hz	1a1b	1340007100
	Screw	AC380V	50/60Hz	1a1b	1340007200
	Screw	AC400V	50/60Hz	1a1b	1340007300
	Screw	AC415V	50/60Hz	1a1b	1340007400
	Screw	AC440V	50/60Hz	1a1b	1340007500
	Screw	AC500V	50/60Hz	1a1b	1340007600
	Screw	AC550V	50/60Hz	1a1b	1340007700
	Screw	AC24V	50Hz	1a1b	1340007800
	Screw	AC32V	50Hz	1a1b	1340018800
	Screw	AC36V	50Hz	1a1b	1340007900
	Screw	AC42V	50Hz	1a1b	1340008000
	Screw	AC48V	50Hz	1a1b	1340008100
	Screw	AC80V	50Hz	1a1b	1340008200
	Screw	AC100V	50Hz	1a1b	1340008300
	Screw	AC110V	50Hz	1a1b	1340008400
	Screw	AC220V	50Hz	1a1b	1340008500
	Screw	AC230V	50Hz	1a1b	1340008600
	Screw	AC240V	50Hz	1a1b	1340008700
	Screw	AC380V	50Hz	1a1b	1340008800
	Screw	AC400V	50Hz	1a1b	1340008900
	Screw	AC415V	50Hz	1a1b	1340009000
	Screw	AC440V	50Hz	1a1b	1340009100
	Screw	AC500V	50Hz	1a1b	1340009200
	Screw	AC550V	50Hz	1a1b	1340009300
	Screw	AC24V	60Hz	1a1b	1340009400
	Screw	AC48V	60Hz	1a1b	1340009500
	Screw	AC100V	60Hz	1a1b	1340009600
	Screw	AC110V	60Hz	1a1b	1340009700
	Screw	AC120V	60Hz	1a1b	1340009800
	Screw	AC200V	60Hz	1a1b	1340009900
	Screw	AC208V	60Hz	1a1b	1340010000
	Screw	AC220V	60Hz	1a1b	1340010100
	Screw	AC230V	60Hz	1a1b	1340010200
	Screw	AC240V	60Hz	1a1b	1340010300
	Screw	AC277V	60Hz	1a1b	1340010400
	Screw	AC380V	60Hz	1a1b	1340010500
	Screw	AC440V	60Hz	1a1b	1340010600
Screw	AC480V	60Hz	1a1b	1340010700	
Screw	AC600V	60Hz	1a1b	1340010800	
Screw	AC100V, 110V	50Hz, 60Hz	1a1b	1340010900	
Screw	AC110V, 120V	50Hz, 60Hz	1a1b	1340011000	
Screw	AC200V, 220V	50Hz, 60Hz	1a1b	1340011100	
Screw	AC240V, 277V	50Hz, 60Hz	1a1b	1340011200	
Screw	DC12V	-	1a1b	1340011300	
Screw	DC20V	-	1a1b	1340011400	
Screw	DC24V	-	1a1b	1340011500	
Screw	DC48V	-	1a1b	1340011600	
Screw	DC60V	-	1a1b	1340011700	
Screw	DC80V	-	1a1b	1340011800	
Screw	DC100V	-	1a1b	1340011900	
Screw	DC110V	-	1a1b	1340012000	
Screw	DC125V	-	1a1b	1340012100	
Screw	DC200V	-	1a1b	1340012200	
Screw	DC220V	-	1a1b	1340012300	
Screw	DC250V	-	1a1b	1340012400	

Contactors

MC-75a screw only type



100AF

Model	Terminal type	Coil Voltage	Frequency	Aux. Contact	Code
MC-75a	Screw	AC24V	50/60Hz	2a2b	1340012500
	Screw	AC48V	50/60Hz	2a2b	1340012600
	Screw	AC100V	50/60Hz	2a2b	1340012700
	Screw	AC110V	50/60Hz	2a2b	1340012800
	Screw	AC120V	50/60Hz	2a2b	1340012900
	Screw	AC200V	50/60Hz	2a2b	1340013000
	Screw	AC220V	50/60Hz	2a2b	1340013100
	Screw	AC230V	50/60Hz	2a2b	1340013200
	Screw	AC240V	50/60Hz	2a2b	1340013300
	Screw	AC380V	50/60Hz	2a2b	1340013400
	Screw	AC400V	50/60Hz	2a2b	1340013500
	Screw	AC415V	50/60Hz	2a2b	1340013600
	Screw	AC440V	50/60Hz	2a2b	1340013700
	Screw	AC500V	50/60Hz	2a2b	1340013800
	Screw	AC550V	50/60Hz	2a2b	1340013900
	Screw	AC24V	50Hz	2a2b	1340014000
	Screw	AC32V	50Hz	2a2b	1340018900
	Screw	AC36V	50Hz	2a2b	1340014100
	Screw	AC42V	50Hz	2a2b	1340014200
	Screw	AC48V	50Hz	2a2b	1340014300
	Screw	AC80V	50Hz	2a2b	1340014400
	Screw	AC100V	50Hz	2a2b	1340014500
	Screw	AC110V	50Hz	2a2b	1340014600
	Screw	AC220V	50Hz	2a2b	1340014700
	Screw	AC230V	50Hz	2a2b	1340014800
	Screw	AC240V	50Hz	2a2b	1340014900
	Screw	AC380V	50Hz	2a2b	1340015000
	Screw	AC400V	50Hz	2a2b	1340015100
	Screw	AC415V	50Hz	2a2b	1340015200
	Screw	AC440V	50Hz	2a2b	1340015300
	Screw	AC500V	50Hz	2a2b	1340015400
	Screw	AC550V	50Hz	2a2b	1340015500
	Screw	AC24V	60Hz	2a2b	1340015600
	Screw	AC48V	60Hz	2a2b	1340015700
	Screw	AC100V	60Hz	2a2b	1340015800
	Screw	AC110V	60Hz	2a2b	1340015900
	Screw	AC120V	60Hz	2a2b	1340016000
	Screw	AC200V	60Hz	2a2b	1340016100
	Screw	AC208V	60Hz	2a2b	1340016200
	Screw	AC220V	60Hz	2a2b	1340016300
	Screw	AC230V	60Hz	2a2b	1340016400
	Screw	AC240V	60Hz	2a2b	1340016500
	Screw	AC277V	60Hz	2a2b	1340016600
	Screw	AC380V	60Hz	2a2b	1340016700
	Screw	AC440V	60Hz	2a2b	1340016800
	Screw	AC480V	60Hz	2a2b	1340016900
	Screw	AC600V	60Hz	2a2b	1340017000
	Screw	AC100V, 110V	50Hz, 60Hz	2a2b	1340017100
	Screw	AC110V, 120V	50Hz, 60Hz	2a2b	1340017200
	Screw	AC200V, 220V	50Hz, 60Hz	2a2b	1340017300
Screw	AC240V, 277V	50Hz, 60Hz	2a2b	1340017400	
Screw	DC12V	-	2a2b	1340017500	
Screw	DC20V	-	2a2b	1340017600	
Screw	DC24V	-	2a2b	1340017700	
Screw	DC48V	-	2a2b	1340017800	
Screw	DC60V	-	2a2b	1340017900	
Screw	DC80V	-	2a2b	1340018000	
Screw	DC100V	-	2a2b	1340018100	
Screw	DC110V	-	2a2b	1340018200	
Screw	DC125V	-	2a2b	1340018300	
Screw	DC200V	-	2a2b	1340018400	
Screw	DC220V	-	2a2b	1340018500	
Screw	DC250V	-	2a2b	1340018600	

Contactors

MC-85a screw only type



100AF

Model	Terminal type	Coil Voltage	Frequency	Aux. Contact	Code
MC-85a	Screw	AC24V	50/60Hz	-	1341000100
	Screw	AC48V	50/60Hz	-	1341000200
	Screw	AC100V	50/60Hz	-	1341000300
	Screw	AC110V	50/60Hz	-	1341000400
	Screw	AC120V	50/60Hz	-	1341000500
	Screw	AC200V	50/60Hz	-	1341000600
	Screw	AC220V	50/60Hz	-	1341000700
	Screw	AC230V	50/60Hz	-	1341000800
	Screw	AC240V	50/60Hz	-	1341019000
	Screw	AC380V	50/60Hz	-	1341001000
	Screw	AC400V	50/60Hz	-	1341019100
	Screw	AC415V	50/60Hz	-	1341001200
	Screw	AC440V	50/60Hz	-	1341001300
	Screw	AC500V	50/60Hz	-	1341001400
	Screw	AC550V	50/60Hz	-	1341001500
	Screw	AC24V	50Hz	-	1341001600
	Screw	AC32V	50Hz	-	1341018700
	Screw	AC36V	50Hz	-	1341001700
	Screw	AC42V	50Hz	-	1341001800
	Screw	AC48V	50Hz	-	1341001900
	Screw	AC80V	50Hz	-	1341002000
	Screw	AC100V	50Hz	-	1341002100
	Screw	AC110V	50Hz	-	1341002200
	Screw	AC220V	50Hz	-	1341002300
	Screw	AC230V	50Hz	-	1341002400
	Screw	AC240V	50Hz	-	1341002500
	Screw	AC380V	50Hz	-	1341002600
	Screw	AC400V	50Hz	-	1341002700
	Screw	AC415V	50Hz	-	1341002800
	Screw	AC440V	50Hz	-	1341002900
	Screw	AC500V	50Hz	-	1341003000
	Screw	AC550V	50Hz	-	1341003100
	Screw	AC24V	60Hz	-	1341003200
	Screw	AC48V	60Hz	-	1341003300
	Screw	AC100V	60Hz	-	1341003400
	Screw	AC110V	60Hz	-	1341003500
	Screw	AC120V	60Hz	-	1341003600
	Screw	AC200V	60Hz	-	1341003700
	Screw	AC208V	60Hz	-	1341003800
	Screw	AC220V	60Hz	-	1341003900
	Screw	AC230V	60Hz	-	1341004000
	Screw	AC240V	60Hz	-	1341004100
	Screw	AC277V	60Hz	-	1341004200
	Screw	AC380V	60Hz	-	1341004300
	Screw	AC440V	60Hz	-	1341004400
Screw	AC480V	60Hz	-	1341004500	
Screw	AC600V	60Hz	-	1341004600	
Screw	AC100V, 110V	50Hz, 60Hz	-	1341004700	
Screw	AC110V, 120V	50Hz, 60Hz	-	1341004800	
Screw	AC200V, 220V	50Hz, 60Hz	-	1341004900	
Screw	AC240V, 277V	50Hz, 60Hz	-	1341005000	
Screw	DC12V	-	-	1341005100	
Screw	DC20V	-	-	1341005200	
Screw	DC24V	-	-	1341005300	
Screw	DC48V	-	-	1341005400	
Screw	DC60V	-	-	1341005500	
Screw	DC80V	-	-	1341005600	
Screw	DC100V	-	-	1341005700	
Screw	DC110V	-	-	1341005800	
Screw	DC125V	-	-	1341005900	
Screw	DC200V	-	-	1341006000	
Screw	DC250V	-	-	1341006100	
Screw	DC220V	-	-	1341006200	

Contactors

MC-85a screw only type



100AF

Model	Terminal type	Coil Voltage	Frequency	Aux. Contact	Code
MC-85a	Screw	AC24V	50/60Hz	1a1b	1341006300
	Screw	AC48V	50/60Hz	1a1b	1341006400
	Screw	AC100V	50/60Hz	1a1b	1341006500
	Screw	AC110V	50/60Hz	1a1b	1341006600
	Screw	AC120V	50/60Hz	1a1b	1341006700
	Screw	AC200V	50/60Hz	1a1b	1341006800
	Screw	AC220V	50/60Hz	1a1b	1341006900
	Screw	AC230V	50/60Hz	1a1b	1341007000
	Screw	AC240V	50/60Hz	1a1b	1341007100
	Screw	AC380V	50/60Hz	1a1b	1341007200
	Screw	AC400V	50/60Hz	1a1b	1341007300
	Screw	AC415V	50/60Hz	1a1b	1341007400
	Screw	AC440V	50/60Hz	1a1b	1341007500
	Screw	AC500V	50/60Hz	1a1b	1341007600
	Screw	AC550V	50/60Hz	1a1b	1341007700
	Screw	AC24V	50Hz	1a1b	1341007800
	Screw	AC32V	50Hz	1a1b	1341018800
	Screw	AC36V	50Hz	1a1b	1341007900
	Screw	AC42V	50Hz	1a1b	1341008000
	Screw	AC48V	50Hz	1a1b	1341008100
	Screw	AC80V	50Hz	1a1b	1341008200
	Screw	AC100V	50Hz	1a1b	1341008300
	Screw	AC110V	50Hz	1a1b	1341008400
	Screw	AC220V	50Hz	1a1b	1341008500
	Screw	AC230V	50Hz	1a1b	1341008600
	Screw	AC240V	50Hz	1a1b	1341008700
	Screw	AC380V	50Hz	1a1b	1341008800
	Screw	AC400V	50Hz	1a1b	1341008900
	Screw	AC415V	50Hz	1a1b	1341009000
	Screw	AC440V	50Hz	1a1b	1341009100
	Screw	AC500V	50Hz	1a1b	1341009200
	Screw	AC550V	50Hz	1a1b	1341009300
	Screw	AC24V	60Hz	1a1b	1341009400
	Screw	AC48V	60Hz	1a1b	1341009500
	Screw	AC100V	60Hz	1a1b	1341009600
	Screw	AC110V	60Hz	1a1b	1341009700
	Screw	AC120V	60Hz	1a1b	1341009800
	Screw	AC200V	60Hz	1a1b	1341009900
	Screw	AC208V	60Hz	1a1b	1341010000
	Screw	AC220V	60Hz	1a1b	1341010100
	Screw	AC230V	60Hz	1a1b	1341010200
	Screw	AC240V	60Hz	1a1b	1341010300
	Screw	AC277V	60Hz	1a1b	1341010400
	Screw	AC380V	60Hz	1a1b	1341010500
	Screw	AC440V	60Hz	1a1b	1341010600
Screw	AC480V	60Hz	1a1b	1341010700	
Screw	AC600V	60Hz	1a1b	1341010800	
Screw	AC100V, 110V	50Hz, 60Hz	1a1b	1341010900	
Screw	AC110V, 120V	50Hz, 60Hz	1a1b	1341011000	
Screw	AC200V, 220V	50Hz, 60Hz	1a1b	1341011100	
Screw	AC240V, 277V	50Hz, 60Hz	1a1b	1341011200	
Screw	DC12V	-	1a1b	1341011300	
Screw	DC20V	-	1a1b	1341011400	
Screw	DC24V	-	1a1b	1341011500	
Screw	DC48V	-	1a1b	1341011600	
Screw	DC60V	-	1a1b	1341011700	
Screw	DC80V	-	1a1b	1341011800	
Screw	DC100V	-	1a1b	1341011900	
Screw	DC110V	-	1a1b	1341012000	
Screw	DC125V	-	1a1b	1341012100	
Screw	DC200V	-	1a1b	1341012200	
Screw	DC220V	-	1a1b	1341012300	
Screw	DC250V	-	1a1b	1341012400	

Contactors

MC-85a screw only type



100AF

Model	Terminal type	Coil Voltage	Frequency	Aux. Contact	Code
MC-85a	Screw	AC24V	50/60Hz	2a2b	1341012500
	Screw	AC48V	50/60Hz	2a2b	1341012600
	Screw	AC100V	50/60Hz	2a2b	1341012700
	Screw	AC110V	50/60Hz	2a2b	1341012800
	Screw	AC120V	50/60Hz	2a2b	1341012900
	Screw	AC200V	50/60Hz	2a2b	1341013000
	Screw	AC220V	50/60Hz	2a2b	1341013100
	Screw	AC230V	50/60Hz	2a2b	1341013200
	Screw	AC240V	50/60Hz	2a2b	1341013300
	Screw	AC380V	50/60Hz	2a2b	1341013400
	Screw	AC400V	50/60Hz	2a2b	1341013500
	Screw	AC415V	50/60Hz	2a2b	1341013600
	Screw	AC440V	50/60Hz	2a2b	1341013700
	Screw	AC500V	50/60Hz	2a2b	1341013800
	Screw	AC550V	50/60Hz	2a2b	1341013900
	Screw	AC24V	50Hz	2a2b	1341014000
	Screw	AC32V	50Hz	2a2b	1341018900
	Screw	AC36V	50Hz	2a2b	1341014100
	Screw	AC42V	50Hz	2a2b	1341014200
	Screw	AC48V	50Hz	2a2b	1341014300
	Screw	AC80V	50Hz	2a2b	1341014400
	Screw	AC100V	50Hz	2a2b	1341014500
	Screw	AC110V	50Hz	2a2b	1341014600
	Screw	AC220V	50Hz	2a2b	1341014700
	Screw	AC230V	50Hz	2a2b	1341014800
	Screw	AC240V	50Hz	2a2b	1341014900
	Screw	AC380V	50Hz	2a2b	1341015000
	Screw	AC400V	50Hz	2a2b	1341015100
	Screw	AC415V	50Hz	2a2b	1341015200
	Screw	AC440V	50Hz	2a2b	1341015300
	Screw	AC500V	50Hz	2a2b	1341015400
	Screw	AC550V	50Hz	2a2b	1341015500
	Screw	AC24V	60Hz	2a2b	1341015600
	Screw	AC48V	60Hz	2a2b	1341015700
	Screw	AC100V	60Hz	2a2b	1341015800
	Screw	AC110V	60Hz	2a2b	1341015900
	Screw	AC120V	60Hz	2a2b	1341016000
	Screw	AC200V	60Hz	2a2b	1341016100
	Screw	AC208V	60Hz	2a2b	1341016200
	Screw	AC220V	60Hz	2a2b	1341016300
	Screw	AC230V	60Hz	2a2b	1341016400
	Screw	AC240V	60Hz	2a2b	1341016500
	Screw	AC277V	60Hz	2a2b	1341016600
	Screw	AC380V	60Hz	2a2b	1341016700
	Screw	AC440V	60Hz	2a2b	1341016800
	Screw	AC480V	60Hz	2a2b	1341016900
	Screw	AC600V	60Hz	2a2b	1341017000
	Screw	AC100V, 110V	50Hz, 60Hz	2a2b	1341017100
	Screw	AC110V, 120V	50Hz, 60Hz	2a2b	1341017200
	Screw	AC200V, 220V	50Hz, 60Hz	2a2b	1341017300
Screw	AC240V, 277V	50Hz, 60Hz	2a2b	1341017400	
Screw	DC12V	-	2a2b	1341017500	
Screw	DC20V	-	2a2b	1341017600	
Screw	DC24V	-	2a2b	1341017700	
Screw	DC48V	-	2a2b	1341017800	
Screw	DC60V	-	2a2b	1341017900	
Screw	DC80V	-	2a2b	1341018000	
Screw	DC100V	-	2a2b	1341018100	
Screw	DC110V	-	2a2b	1341018200	
Screw	DC125V	-	2a2b	1341018300	
Screw	DC200V	-	2a2b	1341018400	
Screw	DC220V	-	2a2b	1341018500	
Screw	DC250V	-	2a2b	1341018600	

Contactors

MC-100a screw only type



100AF

Model	Terminal type	Coil Voltage	Frequency	Aux. Contact	Code
MC-100a	Screw	AC24V	50/60Hz	-	1342000100
	Screw	AC48V	50/60Hz	-	1342000200
	Screw	AC100V	50/60Hz	-	1342000300
	Screw	AC110V	50/60Hz	-	1342000400
	Screw	AC120V	50/60Hz	-	1342000500
	Screw	AC200V	50/60Hz	-	1342000600
	Screw	AC220V	50/60Hz	-	1342000700
	Screw	AC230V	50/60Hz	-	1342000800
	Screw	AC240V	50/60Hz	-	1342019000
	Screw	AC380V	50/60Hz	-	1342001000
	Screw	AC400V	50/60Hz	-	1342001100
	Screw	AC415V	50/60Hz	-	1342001200
	Screw	AC440V	50/60Hz	-	1342001300
	Screw	AC500V	50/60Hz	-	1342001400
	Screw	AC550V	50/60Hz	-	1342001500
	Screw	AC24V	50Hz	-	1342001600
	Screw	AC32V	50Hz	-	1342018700
	Screw	AC36V	50Hz	-	1342001700
	Screw	AC42V	50Hz	-	1342001800
	Screw	AC48V	50Hz	-	1342001900
	Screw	AC80V	50Hz	-	1342002000
	Screw	AC100V	50Hz	-	1342002100
	Screw	AC110V	50Hz	-	1342002200
	Screw	AC220V	50Hz	-	1342002300
	Screw	AC230V	50Hz	-	1342002400
	Screw	AC240V	50Hz	-	1342002500
	Screw	AC380V	50Hz	-	1342002600
	Screw	AC400V	50Hz	-	1342002700
	Screw	AC415V	50Hz	-	1342002800
	Screw	AC440V	50Hz	-	1342002900
	Screw	AC500V	50Hz	-	1342003000
	Screw	AC550V	50Hz	-	1342003100
	Screw	AC24V	60Hz	-	1342003200
	Screw	AC48V	60Hz	-	1342003300
	Screw	AC100V	60Hz	-	1342003400
	Screw	AC110V	60Hz	-	1342003500
	Screw	AC120V	60Hz	-	1342003600
	Screw	AC200V	60Hz	-	1342003700
	Screw	AC208V	60Hz	-	1342003800
	Screw	AC220V	60Hz	-	1342003900
	Screw	AC230V	60Hz	-	1342004000
	Screw	AC240V	60Hz	-	1342004100
	Screw	AC277V	60Hz	-	1342004200
	Screw	AC380V	60Hz	-	1342004300
	Screw	AC440V	60Hz	-	1342004400
	Screw	AC480V	60Hz	-	1342004500
	Screw	AC600V	60Hz	-	1342004600
	Screw	AC100V, 110V	50Hz, 60Hz	-	1342004700
	Screw	AC110V, 120V	50Hz, 60Hz	-	1342004800
	Screw	AC200V, 220V	50Hz, 60Hz	-	1342004900
Screw	AC240V, 277V	50Hz, 60Hz	-	1342005000	
Screw	DC12V	-	-	1342005100	
Screw	DC20V	-	-	1342005200	
Screw	DC24V	-	-	1342005300	
Screw	DC48V	-	-	1342005400	
Screw	DC60V	-	-	1342005500	
Screw	DC80V	-	-	1342005600	
Screw	DC100V	-	-	1342005700	
Screw	DC110V	-	-	1342005800	
Screw	DC125V	-	-	1342005900	
Screw	DC200V	-	-	1342006000	
Screw	DC250V	-	-	1342006100	
Screw	DC220V	-	-	1342006200	

Contactors

MC-100a screw only type



100AF

Model	Terminal type	Coil Voltage	Frequency	Aux. Contact	Code
MC-100a	Screw	AC24V	50/60Hz	1a1b	1342006300
	Screw	AC48V	50/60Hz	1a1b	1342006400
	Screw	AC100V	50/60Hz	1a1b	1342006500
	Screw	AC110V	50/60Hz	1a1b	1342006600
	Screw	AC120V	50/60Hz	1a1b	1342006700
	Screw	AC200V	50/60Hz	1a1b	1342006800
	Screw	AC220V	50/60Hz	1a1b	1342006900
	Screw	AC230V	50/60Hz	1a1b	1342007000
	Screw	AC240V	50/60Hz	1a1b	1342007100
	Screw	AC380V	50/60Hz	1a1b	1342007200
	Screw	AC400V	50/60Hz	1a1b	1342007300
	Screw	AC415V	50/60Hz	1a1b	1342007400
	Screw	AC440V	50/60Hz	1a1b	1342007500
	Screw	AC500V	50/60Hz	1a1b	1342007600
	Screw	AC550V	50/60Hz	1a1b	1342007700
	Screw	AC24V	50Hz	1a1b	1342007800
	Screw	AC32V	50Hz	1a1b	1342018800
	Screw	AC36V	50Hz	1a1b	1342007900
	Screw	AC42V	50Hz	1a1b	1342008000
	Screw	AC48V	50Hz	1a1b	1342008100
	Screw	AC80V	50Hz	1a1b	1342008200
	Screw	AC100V	50Hz	1a1b	1342008300
	Screw	AC110V	50Hz	1a1b	1342008400
	Screw	AC220V	50Hz	1a1b	1342008500
	Screw	AC230V	50Hz	1a1b	1342008600
	Screw	AC240V	50Hz	1a1b	1342008700
	Screw	AC380V	50Hz	1a1b	1342008800
	Screw	AC400V	50Hz	1a1b	1342008900
	Screw	AC415V	50Hz	1a1b	1342009000
	Screw	AC440V	50Hz	1a1b	1342009100
	Screw	AC500V	50Hz	1a1b	1342009200
	Screw	AC550V	50Hz	1a1b	1342009300
	Screw	AC24V	60Hz	1a1b	1342009400
	Screw	AC48V	60Hz	1a1b	1342009500
	Screw	AC100V	60Hz	1a1b	1342009600
	Screw	AC110V	60Hz	1a1b	1342009700
	Screw	AC120V	60Hz	1a1b	1342009800
	Screw	AC200V	60Hz	1a1b	1342009900
	Screw	AC208V	60Hz	1a1b	1342010000
	Screw	AC220V	60Hz	1a1b	1342010100
	Screw	AC230V	60Hz	1a1b	1342010200
	Screw	AC240V	60Hz	1a1b	1342010300
	Screw	AC277V	60Hz	1a1b	1342010400
	Screw	AC380V	60Hz	1a1b	1342010500
	Screw	AC440V	60Hz	1a1b	1342010600
	Screw	AC480V	60Hz	1a1b	1342010700
	Screw	AC600V	60Hz	1a1b	1342010800
	Screw	AC100V, 110V	50Hz, 60Hz	1a1b	1342010900
	Screw	AC110V, 120V	50Hz, 60Hz	1a1b	1342011000
	Screw	AC200V, 220V	50Hz, 60Hz	1a1b	1342011100
Screw	AC240V, 277V	50Hz, 60Hz	1a1b	1342011200	
Screw	DC12V	-	1a1b	1342011300	
Screw	DC20V	-	1a1b	1342011400	
Screw	DC24V	-	1a1b	1342011500	
Screw	DC48V	-	1a1b	1342011600	
Screw	DC60V	-	1a1b	1342011700	
Screw	DC80V	-	1a1b	1342011800	
Screw	DC100V	-	1a1b	1342011900	
Screw	DC110V	-	1a1b	1342012000	
Screw	DC125V	-	1a1b	1342012100	
Screw	DC200V	-	1a1b	1342012200	
Screw	DC220V	-	1a1b	1342012300	
Screw	DC250V	-	1a1b	1342012400	

Contactors

MC-100a screw only type



100AF

Model	Terminal type	Coil Voltage	Frequency	Aux. Contact	Code
MC-100a	Screw	AC24V	50/60Hz	2a2b	1342012500
	Screw	AC48V	50/60Hz	2a2b	1342012600
	Screw	AC100V	50/60Hz	2a2b	1342012700
	Screw	AC110V	50/60Hz	2a2b	1342012800
	Screw	AC120V	50/60Hz	2a2b	1342012900
	Screw	AC200V	50/60Hz	2a2b	1342013000
	Screw	AC220V	50/60Hz	2a2b	1342013100
	Screw	AC230V	50/60Hz	2a2b	1342013200
	Screw	AC240V	50/60Hz	2a2b	1342013300
	Screw	AC380V	50/60Hz	2a2b	1342013400
	Screw	AC400V	50/60Hz	2a2b	1342013500
	Screw	AC415V	50/60Hz	2a2b	1342013600
	Screw	AC440V	50/60Hz	2a2b	1342013700
	Screw	AC500V	50/60Hz	2a2b	1342013800
	Screw	AC550V	50/60Hz	2a2b	1342013900
	Screw	AC24V	50Hz	2a2b	1342014000
	Screw	AC32V	50Hz	2a2b	1342018900
	Screw	AC36V	50Hz	2a2b	1342014100
	Screw	AC42V	50Hz	2a2b	1342014200
	Screw	AC48V	50Hz	2a2b	1342014300
	Screw	AC80V	50Hz	2a2b	1342014400
	Screw	AC100V	50Hz	2a2b	1342014500
	Screw	AC110V	50Hz	2a2b	1342014600
	Screw	AC220V	50Hz	2a2b	1342014700
	Screw	AC230V	50Hz	2a2b	1342014800
	Screw	AC240V	50Hz	2a2b	1342014900
	Screw	AC380V	50Hz	2a2b	1342015000
	Screw	AC400V	50Hz	2a2b	1342015100
	Screw	AC415V	50Hz	2a2b	1342015200
	Screw	AC440V	50Hz	2a2b	1342015300
	Screw	AC500V	50Hz	2a2b	1342015400
	Screw	AC550V	50Hz	2a2b	1342015500
	Screw	AC24V	60Hz	2a2b	1342015600
	Screw	AC48V	60Hz	2a2b	1342015700
	Screw	AC100V	60Hz	2a2b	1342015800
	Screw	AC110V	60Hz	2a2b	1342015900
	Screw	AC120V	60Hz	2a2b	1342016000
	Screw	AC200V	60Hz	2a2b	1342016100
	Screw	AC208V	60Hz	2a2b	1342016200
	Screw	AC220V	60Hz	2a2b	1342016300
	Screw	AC230V	60Hz	2a2b	1342016400
	Screw	AC240V	60Hz	2a2b	1342016500
	Screw	AC277V	60Hz	2a2b	1342016600
	Screw	AC380V	60Hz	2a2b	1342016700
	Screw	AC440V	60Hz	2a2b	1342016800
Screw	AC480V	60Hz	2a2b	1342016900	
Screw	AC600V	60Hz	2a2b	1342017000	
Screw	AC100V, 110V	50Hz, 60Hz	2a2b	1342017100	
Screw	AC110V, 120V	50Hz, 60Hz	2a2b	1342017200	
Screw	AC200V, 220V	50Hz, 60Hz	2a2b	1342017300	
Screw	AC240V, 277V	50Hz, 60Hz	2a2b	1342017400	
Screw	DC12V	-	2a2b	1342017500	
Screw	DC20V	-	2a2b	1342017600	
Screw	DC24V	-	2a2b	1342017700	
Screw	DC48V	-	2a2b	1342017800	
Screw	DC60V	-	2a2b	1342017900	
Screw	DC80V	-	2a2b	1342018000	
Screw	DC100V	-	2a2b	1342018100	
Screw	DC110V	-	2a2b	1342018200	
Screw	DC125V	-	2a2b	1342018300	
Screw	DC200V	-	2a2b	1342018400	
Screw	DC220V	-	2a2b	1342018500	
Screw	DC250V	-	2a2b	1342018600	

Contactors

MC-130a ~ MC-150a screw only type



100AF

Model	Terminal type	Coil Voltage	Frequency	Aux. Contact	Code
MC-130a	Screw	AC200V	50/60Hz	-	1362000100
	Screw	AC24V	50/60Hz	-	1362000200
	Screw	AC48V	50/60Hz	-	1362000300
	Screw	AC110V	50/60Hz	-	1362000400
	Screw	AC300V	50/60Hz	-	1362000500
	Screw	AC400V	50/60Hz	-	1362000600
	Screw	AC500V	50/60Hz	-	1362000700
	Screw	DC24V	-	-	1362000800
	Screw	DC48V	-	-	1362000900
	Screw	DC110V	-	-	1362001000
	Screw	DC220V	-	-	1362001100
	Screw	AC220V	50/60Hz	1a1b	1362001200
	Screw	AC24V	50/60Hz	1a1b	1362001300
	Screw	AC48V	50/60Hz	1a1b	1362001400
	Screw	AC110V	50/60Hz	1a1b	1362001500
	Screw	AC300V	50/60Hz	1a1b	1362001600
	Screw	AC400V	50/60Hz	1a1b	1362001700
	Screw	AC500V	50/60Hz	1a1b	1362001800
	Screw	DC24V	-	1a1b	1362001900
	Screw	DC48V	-	1a1b	1362002000
	Screw	DC110V	-	1a1b	1362002100
	Screw	DC220V	-	1a1b	1362002200
	Screw	AC220V	50/60Hz	2a2b	1362002300
	Screw	AC24V	50/60Hz	2a2b	1362002400
	Screw	AC48V	50/60Hz	2a2b	1362002500
	Screw	AC110V	50/60Hz	2a2b	1362002600
	Screw	AC300V	50/60Hz	2a2b	1362002700
	Screw	AC400V	50/60Hz	2a2b	1362002800
	Screw	AC500V	50/60Hz	2a2b	1362002900
	Screw	DC24V	-	2a2b	1362003000
	Screw	DC48V	-	2a2b	1362003100
	Screw	DC110V	-	2a2b	1362003200
	Screw	DC220V	-	2a2b	1362003300
MC-150a	Screw	AC220V	50/60Hz	-	1364000100
	Screw	AC24V	50/60Hz	-	1364000200
	Screw	AC48V	50/60Hz	-	1364000300
	Screw	AC110V	50/60Hz	-	1364000400
	Screw	AC300V	50/60Hz	-	1364000500
	Screw	AC400V	50/60Hz	-	1364000600
	Screw	AC500V	50/60Hz	-	1364000700
	Screw	DC24V	-	-	1364000800
	Screw	DC48V	-	-	1364000900
	Screw	DC110V	-	-	1364001000
	Screw	DC220V	-	-	1364001100
	Screw	AC220V	50/60Hz	1a1b	1364001200
	Screw	AC24V	50/60Hz	1a1b	1364001300
	Screw	AC48V	50/60Hz	1a1b	1364001400
	Screw	AC110V	50/60Hz	1a1b	1364001500
	Screw	AC300V	50/60Hz	1a1b	1364001600
	Screw	AC400V	50/60Hz	1a1b	1364001700
	Screw	AC500V	50/60Hz	1a1b	1364001800
	Screw	DC24V	-	1a1b	1364001900
	Screw	DC48V	-	1a1b	1364002000
	Screw	DC110V	-	1a1b	1364002100
	Screw	DC220V	-	1a1b	1364002200
	Screw	AC220V	50/60Hz	2a2b	1364002300
	Screw	AC24V	50/60Hz	2a2b	1364002400
	Screw	AC48V	50/60Hz	2a2b	1364002500
	Screw	AC110V	50/60Hz	2a2b	1364002600
	Screw	AC300V	50/60Hz	2a2b	1364002700
	Screw	AC400V	50/60Hz	2a2b	1364002800
	Screw	AC500V	50/60Hz	2a2b	1364002900
	Screw	DC24V	-	2a2b	1364003000
	Screw	DC48V	-	2a2b	1364003100
	Screw	DC110V	-	2a2b	1364003200
	Screw	DC220V	-	2a2b	1364003300



150AF

Contactors

MC-185a ~ MC-800a screw only type

Model	Terminal type	Coil Voltage	Frequency	Aux. Contact	Code
MC-185a	Screw	AC/DC100-200V	50/60Hz	2a2b	1366000200
	Screw	AC/DC24V	50/60Hz	2a2b	1366000300
	Screw	AC/DC48V	50/60Hz	2a2b	1366000400
	Screw	AC300V	50/60Hz	2a2b	1366000500
	Screw	AC400V	50/60Hz	2a2b	1366000600
MC-225a	Screw	AC/DC100-200V	50/60Hz	2a2b	1368000200
	Screw	AC/DC24V	50/60Hz	2a2b	1368000300
	Screw	AC/DC48V	50/60Hz	2a2b	1368000400
	Screw	AC300V	50/60Hz	2a2b	1368000500
	Screw	AC400V	50/60Hz	2a2b	1368000600
MC-265a	Screw	AC/DC100-200V	50/60Hz	2a2b	1369000200
	Screw	AC300V	50/60Hz	2a2b	1369000300
	Screw	AC400V	50/60Hz	2a2b	1369000400
MC-330a	Screw	AC/DC100-200V	50/60Hz	2a2b	1370000200
	Screw	AC300V	50/60Hz	2a2b	1370000300
	Screw	AC400V	50/60Hz	2a2b	1370000400
MC-400a	Screw	AC/DC100-200V	50/60Hz	2a2b	1371000200
	Screw	AC300V	50/60Hz	2a2b	1371000300
	Screw	AC400V	50/60Hz	2a2b	1371000400
	Screw	AC500V	50/60Hz	2a2b	1371000500
MC-500a	Screw	AC/DC200V	50/60Hz	2a2b	1372000200
	Screw	AC/DC100V	50/60Hz	2a2b	1372000300
	Screw	AC300V	50/60Hz	2a2b	1372000400
	Screw	AC400V	50/60Hz	2a2b	1372000500
MC-630a	Screw	AC/DC200V	50/60Hz	2a2b	1373000200
	Screw	AC/DC100V	50/60Hz	2a2b	1373000300
	Screw	AC300V	50/60Hz	2a2b	1373000400
	Screw	AC400V	50/60Hz	2a2b	1373000500
	Screw	AC500V	50/60Hz	2a2b	1373000600
MC-800a	Screw	AC/DC200V	50/60Hz	2a2b	1374000200
	Screw	AC/DC100V	50/60Hz	2a2b	1374000300
	Screw	AC300V	50/60Hz	2a2b	1374000400
	Screw	AC400V	50/60Hz	2a2b	1374000500
	Screw	AC500V	50/60Hz	2a2b	1374000600

Contactors

MC-50a Lug type



65AF

Model	Terminal type	Coil Voltage	Frequency	Aux. Contact	Code
MC-50a	Lug	AC24V	50/60Hz	-	1380000100
	Lug	AC48V	50/60Hz	-	1380000200
	Lug	AC110V	50/60Hz	-	1380000300
	Lug	AC220V	50/60Hz	-	1380000400
	Lug	AC240V	50/60Hz	-	1380000500
	Lug	AC380V	50/60Hz	-	1380000600
	Lug	AC400V	50/60Hz	-	1380000700
	Lug	AC440V	50/60Hz	-	1380000800
	Lug	AC500V	50/60Hz	-	1380000900
	Lug	AC550V	50/60Hz	-	1380001000
	Lug	AC230V	50/60Hz	-	1380001100
	Lug	AC200V	50/60Hz	-	1380001200
	Lug	AC120V	50/60Hz	-	1380001300
	Lug	AC100V	50/60Hz	-	1380001400
	Lug	AC415V	50/60Hz	-	1380001500
	Lug	AC24V	60Hz	-	1380001600
	Lug	AC48V	60Hz	-	1380001700
	Lug	AC110V	60Hz	-	1380001800
	Lug	AC120V	60Hz	-	1380001900
	Lug	AC220V	60Hz	-	1380002000
	Lug	AC240V	60Hz	-	1380002100
	Lug	AC380V	60Hz	-	1380002200
	Lug	AC440V	60Hz	-	1380002300
	Lug	AC480V	60Hz	-	1380002400
	Lug	AC600V	60Hz	-	1380002500
	Lug	AC100V, 110V	50Hz, 60Hz	-	1380002600
	Lug	AC200V, 220V	50Hz, 60Hz	-	1380002700
	Lug	AC208V	60Hz	-	1380002800
	Lug	AC277V	60Hz	-	1380002900
	Lug	AC24V	50Hz	-	1380003000
	Lug	AC48V	50Hz	-	1380003100
	Lug	AC110V	50Hz	-	1380003200
	Lug	AC220V	50Hz	-	1380003300
	Lug	AC240V	50Hz	-	1380003400
	Lug	AC380V	50Hz	-	1380003500
	Lug	AC400V	50Hz	-	1380003600
	Lug	AC415V	50Hz	-	1380003700
	Lug	AC440V	50Hz	-	1380003800
	Lug	AC550V	50Hz	-	1380003900
	Lug	AC36V	50Hz	-	1380004000
	Lug	AC42V	50Hz	-	1380004100
	Lug	AC80V	50Hz	-	1380004200
Lug	AC100V	50Hz	-	1380004300	
Lug	AC230V	50Hz	-	1380004400	
Lug	AC500V	50Hz	-	1380004500	
Lug	AC32V	50Hz	-	1380004600	
Lug	DC12V	-	-	1380004700	
Lug	DC24V	-	-	1380004800	
Lug	DC48V	-	-	1380004900	
Lug	DC100V	-	-	1380005000	
Lug	DC110V	-	-	1380005100	
Lug	DC125V	-	-	1380005200	
Lug	DC200V	-	-	1380005300	
Lug	DC220V	-	-	1380005400	
Lug	DC250V	-	-	1380005500	
Lug	DC20V	-	-	1380005600	

Contactors

MC-50a Lug type



65AF

Model	Terminal type	Coil Voltage	Frequency	Aux. Contact	Code
MC-50a	Lug	DC60V	-	-	1380005700
	Lug	DC80V	-	-	1380005800
	Lug	AC24V	50/60Hz	1a1b	1380005900
	Lug	AC48V	50/60Hz	1a1b	1380006000
	Lug	AC110V	50/60Hz	1a1b	1380006100
	Lug	AC220V	50/60Hz	1a1b	1380006200
	Lug	AC240V	50/60Hz	1a1b	1380006300
	Lug	AC380V	50/60Hz	1a1b	1380006400
	Lug	AC400V	50/60Hz	1a1b	1380006500
	Lug	AC440V	50/60Hz	1a1b	1380006600
	Lug	AC500V	50/60Hz	1a1b	1380006700
	Lug	AC550V	50/60Hz	1a1b	1380006800
	Lug	AC230V	50/60Hz	1a1b	1380006900
	Lug	AC200V	50/60Hz	1a1b	1380007000
	Lug	AC120V	50/60Hz	1a1b	1380007100
	Lug	AC100V	50/60Hz	1a1b	1380007200
	Lug	AC415V	50/60Hz	1a1b	1380007300
	Lug	AC24V	60Hz	1a1b	1380007400
	Lug	AC48V	60Hz	1a1b	1380007500
	Lug	AC110V	60Hz	1a1b	1380007600
	Lug	AC120V	60Hz	1a1b	1380007700
	Lug	AC220V	60Hz	1a1b	1380007800
	Lug	AC240V	60Hz	1a1b	1380007900
	Lug	AC380V	60Hz	1a1b	1380008000
	Lug	AC440V	60Hz	1a1b	1380008100
	Lug	AC480V	60Hz	1a1b	1380008200
	Lug	AC600V	60Hz	1a1b	1380008300
	Lug	AC100V, 110V	50Hz, 60Hz	1a1b	1380008400
	Lug	AC200V, 220V	50Hz, 60Hz	1a1b	1380008500
	Lug	AC208V	60Hz	1a1b	1380008600
	Lug	AC277V	60Hz	1a1b	1380008700
	Lug	AC24V	50Hz	1a1b	1380008800
	Lug	AC48V	50Hz	1a1b	1380008900
	Lug	AC110V	50Hz	1a1b	1380009000
	Lug	AC220V	50Hz	1a1b	1380009100
	Lug	AC240V	50Hz	1a1b	1380009200
	Lug	AC380V	50Hz	1a1b	1380009300
	Lug	AC400V	50Hz	1a1b	1380009400
	Lug	AC415V	50Hz	1a1b	1380009500
	Lug	AC440V	50Hz	1a1b	1380009600
	Lug	AC550V	50Hz	1a1b	1380009700
	Lug	AC36V	50Hz	1a1b	1380009800
	Lug	AC42V	50Hz	1a1b	1380009900
	Lug	AC80V	50Hz	1a1b	1380010000
	Lug	AC100V	50Hz	1a1b	1380010100
	Lug	AC230V	50Hz	1a1b	1380010200
	Lug	AC500V	50Hz	1a1b	1380010300
	Lug	AC32V	50Hz	1a1b	1380010400
	Lug	DC12V	-	1a1b	1380010500
	Lug	DC24V	-	1a1b	1380010600
Lug	DC48V	-	1a1b	1380010700	
Lug	DC100V	-	1a1b	1380010800	
Lug	DC110V	-	1a1b	1380010900	
Lug	DC125V	-	1a1b	1380011000	
Lug	DC200V	-	1a1b	1380011100	
Lug	DC220V	-	1a1b	1380011200	
Lug	DC250V	-	1a1b	1380011300	
Lug	DC20V	-	1a1b	1380011400	
Lug	DC60V	-	1a1b	1380011500	
Lug	DC80V	-	1a1b	1380011600	
Lug	AC24V	50/60Hz	2a2b	1380011700	
Lug	AC48V	50/60Hz	2a2b	1380011800	

Contactors

MC-50a Lug type



65AF

Model	Terminal type	Coil Voltage	Frequency	Aux. Contact	Code
MC-50a	Lug	AC110V	50/60Hz	2a2b	1380011900
	Lug	AC220V	50/60Hz	2a2b	1380012000
	Lug	AC240V	50/60Hz	2a2b	1380012100
	Lug	AC380V	50/60Hz	2a2b	1380012200
	Lug	AC400V	50/60Hz	2a2b	1380012300
	Lug	AC440V	50/60Hz	2a2b	1380012400
	Lug	AC500V	50/60Hz	2a2b	1380012500
	Lug	AC550V	50/60Hz	2a2b	1380012600
	Lug	AC230V	50/60Hz	2a2b	1380012700
	Lug	AC200V	50/60Hz	2a2b	1380012800
	Lug	AC120V	50/60Hz	2a2b	1380012900
	Lug	AC100V	50/60Hz	2a2b	1380013000
	Lug	AC415V	50/60Hz	2a2b	1380013100
	Lug	AC24V	60Hz	2a2b	1380013200
	Lug	AC48V	60Hz	2a2b	1380013300
	Lug	AC110V	60Hz	2a2b	1380013400
	Lug	AC120V	60Hz	2a2b	1380013500
	Lug	AC220V	60Hz	2a2b	1380013600
	Lug	AC240V	60Hz	2a2b	1380013700
	Lug	AC380V	60Hz	2a2b	1380013800
	Lug	AC440V	60Hz	2a2b	1380013900
	Lug	AC480V	60Hz	2a2b	1380014000
	Lug	AC600V	60Hz	2a2b	1380014100
	Lug	AC100V, 110V	50Hz, 60Hz	2a2b	1380014200
	Lug	AC200V, 220V	50Hz, 60Hz	2a2b	1380014300
	Lug	AC208V	60Hz	2a2b	1380014400
	Lug	AC277V	60Hz	2a2b	1380014500
	Lug	AC24V	50Hz	2a2b	1380014600
	Lug	AC48V	50Hz	2a2b	1380014700
	Lug	AC110V	50Hz	2a2b	1380014800
	Lug	AC220V	50Hz	2a2b	1380014900
	Lug	AC240V	50Hz	2a2b	1380015000
	Lug	AC380V	50Hz	2a2b	1380015100
	Lug	AC400V	50Hz	2a2b	1380015200
	Lug	AC415V	50Hz	2a2b	1380015300
	Lug	AC440V	50Hz	2a2b	1380015400
	Lug	AC550V	50Hz	2a2b	1380015500
	Lug	AC36V	50Hz	2a2b	1380015600
	Lug	AC42V	50Hz	2a2b	1380015700
	Lug	AC80V	50Hz	2a2b	1380015800
	Lug	AC100V	50Hz	2a2b	1380015900
	Lug	AC230V	50Hz	2a2b	1380016000
	Lug	AC500V	50Hz	2a2b	1380016100
	Lug	AC32V	50Hz	2a2b	1380016200
	Lug	DC12V	-	2a2b	1380016300
Lug	DC24V	-	2a2b	1380016400	
Lug	DC48V	-	2a2b	1380016500	
Lug	DC100V	-	2a2b	1380016600	
Lug	DC110V	-	2a2b	1380016700	
Lug	DC125V	-	2a2b	1380016800	
Lug	DC200V	-	2a2b	1380016900	
Lug	DC220V	-	2a2b	1380017000	
Lug	DC250V	-	2a2b	1380017100	
Lug	DC20V	-	2a2b	1380017200	
Lug	DC60V	-	2a2b	1380017300	
Lug	DC80V	-	2a2b	1380017400	

Contactors

MC-65a Lug type



65AF

Model	Terminal type	Coil Voltage	Frequency	Aux. Contact	Code
MC-65a	Lug	AC24V	50/60Hz	-	1381000100
	Lug	AC48V	50/60Hz	-	1381000300
	Lug	AC110V	50/60Hz	-	1381000400
	Lug	AC220V	50/60Hz	-	1381000500
	Lug	AC240V	50/60Hz	-	1381000600
	Lug	AC380V	50/60Hz	-	1381000700
	Lug	AC400V	50/60Hz	-	1381000800
	Lug	AC440V	50/60Hz	-	1381000900
	Lug	AC500V	50/60Hz	-	1381001000
	Lug	AC550V	50/60Hz	-	1381001100
	Lug	AC230V	50/60Hz	-	1381001200
	Lug	AC200V	50/60Hz	-	1381001300
	Lug	AC120V	50/60Hz	-	1381001400
	Lug	AC100V	50/60Hz	-	1381001500
	Lug	AC415V	50/60Hz	-	1381001600
	Lug	AC24V	60Hz	-	1381001700
	Lug	AC48V	60Hz	-	1381001800
	Lug	AC110V	60Hz	-	1381001900
	Lug	AC120V	60Hz	-	1381002000
	Lug	AC220V	60Hz	-	1381002100
	Lug	AC240V	60Hz	-	1381002200
	Lug	AC380V	60Hz	-	1381002300
	Lug	AC440V	60Hz	-	1381002400
	Lug	AC480V	60Hz	-	1381002500
	Lug	AC600V	60Hz	-	1381002600
	Lug	AC100V, 110V	50Hz, 60Hz	-	1381002700
	Lug	AC200V, 220V	50Hz, 60Hz	-	1381002800
	Lug	AC208V	60Hz	-	1381002900
	Lug	AC277V	60Hz	-	1381003000
	Lug	AC24V	50Hz	-	1381003100
	Lug	AC48V	50Hz	-	1381003200
	Lug	AC110V	50Hz	-	1381003300
	Lug	AC220V	50Hz	-	1381003400
	Lug	AC240V	50Hz	-	1381003500
	Lug	AC380V	50Hz	-	1381003600
	Lug	AC400V	50Hz	-	1381003700
	Lug	AC415V	50Hz	-	1381003800
	Lug	AC440V	50Hz	-	1381003900
	Lug	AC550V	50Hz	-	1381004000
	Lug	AC36V	50Hz	-	1381004100
	Lug	AC42V	50Hz	-	1381004200
	Lug	AC80V	50Hz	-	1381004300
	Lug	AC100V	50Hz	-	1381004400
	Lug	AC230V	50Hz	-	1381004500
	Lug	AC500V	50Hz	-	1381004600
	Lug	AC32V	50Hz	-	1381004700
Lug	DC12V	-	-	1381000200	
Lug	DC24V	-	-	1381004800	
Lug	DC48V	-	-	1381004900	
Lug	DC100V	-	-	1381005000	
Lug	DC110V	-	-	1381005100	
Lug	DC125V	-	-	1381005200	
Lug	DC200V	-	-	1381005300	
Lug	DC220V	-	-	1381005400	
Lug	DC250V	-	-	1381005500	
Lug	DC20V	-	-	1381005600	
Lug	DC60V	-	-	1381005700	
Lug	DC80V	-	-	1381005800	
Lug	AC24V	50/60Hz	1a1b	1381005900	
Lug	AC48V	50/60Hz	1a1b	1381006000	
Lug	AC110V	50/60Hz	1a1b	1381006100	
Lug	AC220V	50/60Hz	1a1b	1381006200	

Contactors

MC-65a Lug type



65AF

Model	Terminal type	Coil Voltage	Frequency	Aux. Contact	Code
MC-65a	Lug	AC240V	50/60Hz	1a1b	1381006300
	Lug	AC380V	50/60Hz	1a1b	1381006400
	Lug	AC400V	50/60Hz	1a1b	1381006500
	Lug	AC440V	50/60Hz	1a1b	1381006600
	Lug	AC500V	50/60Hz	1a1b	1381006700
	Lug	AC550V	50/60Hz	1a1b	1381006800
	Lug	AC230V	50/60Hz	1a1b	1381006900
	Lug	AC200V	50/60Hz	1a1b	1381007000
	Lug	AC120V	50/60Hz	1a1b	1381007100
	Lug	AC100V	50/60Hz	1a1b	1381007200
	Lug	AC415V	50/60Hz	1a1b	1381007300
	Lug	AC24V	60Hz	1a1b	1381007400
	Lug	AC48V	60Hz	1a1b	1381007500
	Lug	AC110V	60Hz	1a1b	1381007600
	Lug	AC120V	60Hz	1a1b	1381007700
	Lug	AC220V	60Hz	1a1b	1381007800
	Lug	AC240V	60Hz	1a1b	1381007900
	Lug	AC380V	60Hz	1a1b	1381008000
	Lug	AC440V	60Hz	1a1b	1381008100
	Lug	AC480V	60Hz	1a1b	1381008200
	Lug	AC600V	60Hz	1a1b	1381008400
	Lug	AC100V, 110V	50Hz, 60Hz	1a1b	1381008500
	Lug	AC200V, 220V	50Hz, 60Hz	1a1b	1381008600
	Lug	AC208V	60Hz	1a1b	1381008700
	Lug	AC277V	60Hz	1a1b	1381008800
	Lug	AC24V	50Hz	1a1b	1381008900
	Lug	AC48V	50Hz	1a1b	1381009000
	Lug	AC110V	50Hz	1a1b	1381009100
	Lug	AC220V	50Hz	1a1b	1381009200
	Lug	AC240V	50Hz	1a1b	1381009300
	Lug	AC380V	50Hz	1a1b	1381009400
	Lug	AC400V	50Hz	1a1b	1381009800
	Lug	AC415V	50Hz	1a1b	1381009900
	Lug	AC440V	50Hz	1a1b	1381010000
	Lug	AC550V	50Hz	1a1b	1381010100
	Lug	AC36V	50Hz	1a1b	1381010200
	Lug	AC42V	50Hz	1a1b	1381010300
	Lug	AC80V	50Hz	1a1b	1381010400
	Lug	AC100V	50Hz	1a1b	1381010500
	Lug	AC230V	50Hz	1a1b	1381010600
	Lug	AC500V	50Hz	1a1b	1381010700
	Lug	AC32V	50Hz	1a1b	1381010800
	Lug	DC12V	-	1a1b	1381009500
	Lug	DC24V	-	1a1b	1381010900
	Lug	DC48V	-	1a1b	1381011000
	Lug	DC100V	-	1a1b	1381011100
Lug	DC110V	-	1a1b	1381011200	
Lug	DC125V	-	1a1b	1381011300	
Lug	DC200V	-	1a1b	1381011400	
Lug	DC220V	-	1a1b	1381011500	
Lug	DC250V	-	1a1b	1381011600	
Lug	DC20V	-	1a1b	1381011700	
Lug	DC60V	-	1a1b	1381011800	
Lug	DC80V	-	1a1b	1381011900	
Lug	AC24V	50/60Hz	2a2b	1381009600	
Lug	AC48V	50/60Hz	2a2b	1381012000	

Contactors

MC-65a Lug type



65AF

Model	Terminal type	Coil Voltage	Frequency	Aux. Contact	Code
MC-65a	Lug	AC110V	50/60Hz	2a2b	1381012100
	Lug	AC220V	50/60Hz	2a2b	1381012200
	Lug	AC240V	50/60Hz	2a2b	1381012300
	Lug	AC380V	50/60Hz	2a2b	1381012400
	Lug	AC400V	50/60Hz	2a2b	1381012500
	Lug	AC440V	50/60Hz	2a2b	1381012600
	Lug	AC500V	50/60Hz	2a2b	1381012700
	Lug	AC550V	50/60Hz	2a2b	1381012800
	Lug	AC230V	50/60Hz	2a2b	1381012900
	Lug	AC200V	50/60Hz	2a2b	1381013000
	Lug	AC120V	50/60Hz	2a2b	1381013100
	Lug	AC100V	50/60Hz	2a2b	1381013200
	Lug	AC415V	50/60Hz	2a2b	1381013300
	Lug	AC24V	60Hz	2a2b	1381013400
	Lug	AC48V	60Hz	2a2b	1381013500
	Lug	AC110V	60Hz	2a2b	1381013600
	Lug	AC120V	60Hz	2a2b	1381013700
	Lug	AC220V	60Hz	2a2b	1381013800
	Lug	AC240V	60Hz	2a2b	1381013900
	Lug	AC380V	60Hz	2a2b	1381014000
	Lug	AC440V	60Hz	2a2b	1381014100
	Lug	AC480V	60Hz	2a2b	1381014200
	Lug	AC600V	60Hz	2a2b	1381014300
	Lug	AC100V, 110V	50Hz, 60Hz	2a2b	1381014400
	Lug	AC200V, 220V	50Hz, 60Hz	2a2b	1381014500
	Lug	AC208V	60Hz	2a2b	1381014600
	Lug	AC277V	60Hz	2a2b	1381014700
	Lug	AC24V	50Hz	2a2b	1381014800
	Lug	AC48V	50Hz	2a2b	1381014900
	Lug	AC110V	50Hz	2a2b	1381015000
	Lug	AC220V	50Hz	2a2b	1381015100
	Lug	AC240V	50Hz	2a2b	1381015200
	Lug	AC380V	50Hz	2a2b	1381015300
	Lug	AC400V	50Hz	2a2b	1381015400
	Lug	AC415V	50Hz	2a2b	1381015500
	Lug	AC440V	50Hz	2a2b	1381015600
	Lug	AC550V	50Hz	2a2b	1381015700
	Lug	AC36V	50Hz	2a2b	1381015800
	Lug	AC42V	50Hz	2a2b	1381015900
	Lug	AC80V	50Hz	2a2b	1381016000
	Lug	AC100V	50Hz	2a2b	1381016100
	Lug	AC230V	50Hz	2a2b	1381016200
	Lug	AC500V	50Hz	2a2b	1381016300
	Lug	AC32V	50Hz	2a2b	1381016400
	Lug	DC12V	-	2a2b	1381009700
Lug	DC24V	-	2a2b	1381016500	
Lug	DC48V	-	2a2b	1381016600	
Lug	DC100V	-	2a2b	1381016700	
Lug	DC110V	-	2a2b	1381016800	
Lug	DC125V	-	2a2b	1381016900	
Lug	DC200V	-	2a2b	1381017000	
Lug	DC220V	-	2a2b	1381017100	
Lug	DC250V	-	2a2b	1381017200	
Lug	DC20V	-	2a2b	1381017300	
Lug	DC60V	-	2a2b	1381017400	
Lug	DC80V	-	2a2b	1381017500	

Contactors

MC-75a Lug type



100AF

Model	Terminal type	Coil Voltage	Frequency	Aux. Contact	Code
MC-75a	Lug	AC24V	50/60Hz	-	1382000100
	Lug	AC48V	50/60Hz	-	1382000700
	Lug	AC110V	50/60Hz	-	1382000800
	Lug	AC220V	50/60Hz	-	1382000900
	Lug	AC240V	50/60Hz	-	1382001000
	Lug	AC380V	50/60Hz	-	1382001100
	Lug	AC400V	50/60Hz	-	1382001200
	Lug	AC440V	50/60Hz	-	1382001300
	Lug	AC500V	50/60Hz	-	1382001400
	Lug	AC550V	50/60Hz	-	1382001500
	Lug	AC230V	50/60Hz	-	1382001600
	Lug	AC200V	50/60Hz	-	1382001700
	Lug	AC120V	50/60Hz	-	1382001800
	Lug	AC100V	50/60Hz	-	1382001900
	Lug	AC415V	50/60Hz	-	1382002000
	Lug	AC24V	60Hz	-	1382002100
	Lug	AC48V	60Hz	-	1382002200
	Lug	AC110V	60Hz	-	1382002300
	Lug	AC120V	60Hz	-	1382002400
	Lug	AC220V	60Hz	-	1382002500
	Lug	AC240V	60Hz	-	1382002600
	Lug	AC380V	60Hz	-	1382002700
	Lug	AC440V	60Hz	-	1382002800
	Lug	AC480V	60Hz	-	1382002900
	Lug	AC600V	60Hz	-	1382003000
	Lug	AC100V, 110V	50Hz, 60Hz	-	1382003100
	Lug	AC200V, 220V	50Hz, 60Hz	-	1382003200
	Lug	AC208V	60Hz	-	1382003300
	Lug	AC277V	60Hz	-	1382003400
	Lug	AC24V	50Hz	-	1382003500
	Lug	AC48V	50Hz	-	1382003600
	Lug	AC110V	50Hz	-	1382003700
	Lug	AC220V	50Hz	-	1382003800
	Lug	AC240V	50Hz	-	1382003900
	Lug	AC380V	50Hz	-	1382004000
	Lug	AC400V	50Hz	-	1382004100
	Lug	AC415V	50Hz	-	1382004200
	Lug	AC440V	50Hz	-	1382004300
	Lug	AC500V	50Hz	-	1382004400
	Lug	AC36V	50Hz	-	1382004500
	Lug	AC42V	50Hz	-	1382004600
	Lug	AC80V	50Hz	-	1382004700
	Lug	AC100V	50Hz	-	1382004800
	Lug	AC230V	50Hz	-	1382004900
	Lug	AC500V	50Hz	-	1382005000
	Lug	AC32V	50Hz	-	1382005100
	Lug	DC12V	-	-	1382000200
	Lug	DC24V	-	-	1382005200
	Lug	DC48V	-	-	1382005300
	Lug	DC100V	-	-	1382005400
Lug	DC110V	-	-	1382005500	
Lug	DC125V	-	-	1382005600	
Lug	DC200V	-	-	1382005700	
Lug	DC220V	-	-	1382005800	
Lug	DC250V	-	-	1382005900	
Lug	DC20V	-	-	1382006000	
Lug	DC60V	-	-	1382006100	
Lug	DC80V	-	-	1382006200	
Lug	AC24V	50/60Hz	1a1b	1382000300	
Lug	AC48V	50/60Hz	1a1b	1382006300	
Lug	AC110V	50/60Hz	1a1b	1382006400	
Lug	AC220V	50/60Hz	1a1b	1382006500	

Contactors

MC-75a Lug type



100AF

Model	Terminal type	Coil Voltage	Frequency	Aux. Contact	Code
MC-75a	Lug	AC240V	50/60Hz	1a1b	1382006600
	Lug	AC380V	50/60Hz	1a1b	1382006700
	Lug	AC400V	50/60Hz	1a1b	1382006800
	Lug	AC440V	50/60Hz	1a1b	1382006900
	Lug	AC500V	50/60Hz	1a1b	1382007000
	Lug	AC550V	50/60Hz	1a1b	1382007100
	Lug	AC230V	50/60Hz	1a1b	1382007200
	Lug	AC200V	50/60Hz	1a1b	1382007300
	Lug	AC120V	50/60Hz	1a1b	1382007400
	Lug	AC100V	50/60Hz	1a1b	1382007500
	Lug	AC415V	50/60Hz	1a1b	1382007600
	Lug	AC24V	60Hz	1a1b	1382007700
	Lug	AC48V	60Hz	1a1b	1382007800
	Lug	AC110V	60Hz	1a1b	1382007900
	Lug	AC120V	60Hz	1a1b	1382008000
	Lug	AC220V	60Hz	1a1b	1382008100
	Lug	AC240V	60Hz	1a1b	1382008200
	Lug	AC380V	60Hz	1a1b	1382008300
	Lug	AC440V	60Hz	1a1b	1382008400
	Lug	AC480V	60Hz	1a1b	1382008500
	Lug	AC600V	60Hz	1a1b	1382008600
	Lug	AC100V, 110V	50Hz, 60Hz	1a1b	1382008700
	Lug	AC200V, 220V	50Hz, 60Hz	1a1b	1382008800
	Lug	AC208V	60Hz	1a1b	1382008900
	Lug	AC277V	60Hz	1a1b	1382009000
	Lug	AC24V	50Hz	1a1b	1382009100
	Lug	AC48V	50Hz	1a1b	1382009200
	Lug	AC110V	50Hz	1a1b	1382009300
	Lug	AC220V	50Hz	1a1b	1382009400
	Lug	AC240V	50Hz	1a1b	1382009500
	Lug	AC380V	50Hz	1a1b	1382009600
	Lug	AC400V	50Hz	1a1b	1382009700
	Lug	AC415V	50Hz	1a1b	1382009800
	Lug	AC440V	50Hz	1a1b	1382009900
	Lug	AC550V	50Hz	1a1b	1382010000
	Lug	AC36V	50Hz	1a1b	1382010100
	Lug	AC42V	50Hz	1a1b	1382010200
	Lug	AC80V	50Hz	1a1b	1382010300
	Lug	AC100V	50Hz	1a1b	1382010400
	Lug	AC230V	50Hz	1a1b	1382010500
	Lug	AC500V	50Hz	1a1b	1382010600
	Lug	AC32V	50Hz	1a1b	1382010700
	Lug	DC12V	-	1a1b	1382000400
	Lug	DC24V	-	1a1b	1382016400
	Lug	DC48V	-	1a1b	1382016500
Lug	DC100V	-	1a1b	1382016600	
Lug	DC110V	-	1a1b	1382016700	
Lug	DC125V	-	1a1b	1382016800	
Lug	DC200V	-	1a1b	1382016900	
Lug	DC220V	-	1a1b	1382017000	
Lug	DC250V	-	1a1b	1382017100	
Lug	DC20V	-	1a1b	1382017200	
Lug	DC60V	-	1a1b	1382017300	
Lug	DC80V	-	1a1b	1382017400	
Lug	AC24V	50/60Hz	2a2b	1382000500	
Lug	AC48V	50/60Hz	2a2b	1382011900	

Contactors

MC-75a Lug type



100AF

Model	Terminal type	Coil Voltage	Frequency	Aux. Contact	Code
MC-75a	Lug	AC110V	50/60Hz	2a2b	1382012000
	Lug	AC220V	50/60Hz	2a2b	1382012100
	Lug	AC240V	50/60Hz	2a2b	1382012200
	Lug	AC380V	50/60Hz	2a2b	1382012300
	Lug	AC400V	50/60Hz	2a2b	1382012400
	Lug	AC440V	50/60Hz	2a2b	1382012500
	Lug	AC500V	50/60Hz	2a2b	1382012600
	Lug	AC550V	50/60Hz	2a2b	1382012700
	Lug	AC230V	50/60Hz	2a2b	1382012800
	Lug	AC200V	50/60Hz	2a2b	1382012900
	Lug	AC120V	50/60Hz	2a2b	1382013000
	Lug	AC100V	50/60Hz	2a2b	1382013100
	Lug	AC415V	50/60Hz	2a2b	1382013200
	Lug	AC24V	60Hz	2a2b	1382013300
	Lug	AC48V	60Hz	2a2b	1382013400
	Lug	AC110V	60Hz	2a2b	1382013500
	Lug	AC120V	60Hz	2a2b	1382013600
	Lug	AC220V	60Hz	2a2b	1382013700
	Lug	AC240V	60Hz	2a2b	1382013800
	Lug	AC380V	60Hz	2a2b	1382013900
	Lug	AC440V	60Hz	2a2b	1382014000
	Lug	AC480V	60Hz	2a2b	1382014100
	Lug	AC600V	60Hz	2a2b	1382014200
	Lug	AC100V, 110V	50Hz, 60Hz	2a2b	1382014300
	Lug	AC200V, 220V	50Hz, 60Hz	2a2b	1382014400
	Lug	AC208V	60Hz	2a2b	1382014500
	Lug	AC277V	60Hz	2a2b	1382014600
	Lug	AC24V	50Hz	2a2b	1382014700
	Lug	AC48V	50Hz	2a2b	1382014800
	Lug	AC110V	50Hz	2a2b	1382014900
	Lug	AC220V	50Hz	2a2b	1382015000
	Lug	AC240V	50Hz	2a2b	1382015100
	Lug	AC380V	50Hz	2a2b	1382015200
	Lug	AC400V	50Hz	2a2b	1382015300
	Lug	AC415V	50Hz	2a2b	1382015400
	Lug	AC440V	50Hz	2a2b	1382015500
	Lug	AC550V	50Hz	2a2b	1382015600
	Lug	AC36V	50Hz	2a2b	1382015700
	Lug	AC42V	50Hz	2a2b	1382015800
	Lug	AC80V	50Hz	2a2b	1382015900
	Lug	AC100V	50Hz	2a2b	1382016000
	Lug	AC230V	50Hz	2a2b	1382016100
	Lug	AC500V	50Hz	2a2b	1382016200
	Lug	AC32V	50Hz	2a2b	1382016300
	Lug	DC12V	-	2a2b	1382000600
Lug	DC24V	-	2a2b	1382010800	
Lug	DC48V	-	2a2b	1382010900	
Lug	DC100V	-	2a2b	1382011000	
Lug	DC110V	-	2a2b	1382011100	
Lug	DC125V	-	2a2b	1382011200	
Lug	DC200V	-	2a2b	1382011300	
Lug	DC220V	-	2a2b	1382011400	
Lug	DC250V	-	2a2b	1382011500	
Lug	DC20V	-	2a2b	1382011600	
Lug	DC60V	-	2a2b	1382011700	
Lug	DC80V	-	2a2b	1382011800	

Contactors

MC-85a Lug type



100AF

Model	Terminal type	Coil Voltage	Frequency	Aux. Contact	Code
MC-85a	Lug	AC24V	50/60Hz	-	1383000100
	Lug	AC48V	50/60Hz	-	1383013100
	Lug	AC110V	50/60Hz	-	1383013200
	Lug	AC220V	50/60Hz	-	1383013300
	Lug	AC240V	50/60Hz	-	1383013400
	Lug	AC380V	50/60Hz	-	1383013500
	Lug	AC400V	50/60Hz	-	1383013600
	Lug	AC440V	50/60Hz	-	1383013700
	Lug	AC500V	50/60Hz	-	1383013800
	Lug	AC550V	50/60Hz	-	1383013900
	Lug	AC230V	50/60Hz	-	1383014000
	Lug	AC200V	50/60Hz	-	1383014100
	Lug	AC120V	50/60Hz	-	1383014200
	Lug	AC100V	50/60Hz	-	1383014300
	Lug	AC415V	50/60Hz	-	1383014400
	Lug	AC24V	60Hz	-	1383014500
	Lug	AC48V	60Hz	-	1383014600
	Lug	AC110V	60Hz	-	1383014700
	Lug	AC120V	60Hz	-	1383014900
	Lug	AC220V	60Hz	-	1383015000
	Lug	AC240V	60Hz	-	1383015100
	Lug	AC380V	60Hz	-	1383015200
	Lug	AC440V	60Hz	-	1383015300
	Lug	AC480V	60Hz	-	1383015400
	Lug	AC600V	60Hz	-	1383015500
	Lug	AC100V, 110V	50Hz, 60Hz	-	1383015600
	Lug	AC200V, 220V	50Hz, 60Hz	-	1383015700
	Lug	AC208V	60Hz	-	1383015800
	Lug	AC277V	60Hz	-	1383015900
	Lug	AC24V	50Hz	-	1383016000
	Lug	AC48V	50Hz	-	1383016100
	Lug	AC110V	50Hz	-	1383016200
	Lug	AC220V	50Hz	-	1383016300
	Lug	AC240V	50Hz	-	1383016400
	Lug	AC380V	50Hz	-	1383016500
	Lug	AC400V	50Hz	-	1383016600
	Lug	AC415V	50Hz	-	1383016700
	Lug	AC440V	50Hz	-	1383016800
	Lug	AC550V	50Hz	-	1383016900
	Lug	AC36V	50Hz	-	1383017000
	Lug	AC42V	50Hz	-	1383017100
	Lug	AC80V	50Hz	-	1383017200
	Lug	AC100V	50Hz	-	1383017300
	Lug	AC230V	50Hz	-	1383017400
	Lug	AC500V	50Hz	-	1383017500
	Lug	AC32V	50Hz	-	1383017600
	Lug	DC12V	-	-	1383000300
	Lug	DC24V	-	-	1383012000
	Lug	DC48V	-	-	1383012100
	Lug	DC100V	-	-	1383012200
Lug	DC110V	-	-	1383012300	
Lug	DC125V	-	-	1383012400	
Lug	DC200V	-	-	1383012500	
Lug	DC220V	-	-	1383012600	
Lug	DC250V	-	-	1383012700	
Lug	DC20V	-	-	1383012800	
Lug	DC60V	-	-	1383012900	
Lug	DC80V	-	-	1383013000	
Lug	AC24V	50/60Hz	1a1b	1383000400	
Lug	AC48V	50/60Hz	1a1b	1383007400	
Lug	AC110V	50/60Hz	1a1b	1383007500	
Lug	AC220V	50/60Hz	1a1b	1383007600	

Contactors

MC-85a Lug type



100AF

Model	Terminal type	Coil Voltage	Frequency	Aux. Contact	Code
MC-85a	Lug	AC240V	50/60Hz	1a1b	1383007700
	Lug	AC380V	50/60Hz	1a1b	1383007800
	Lug	AC400V	50/60Hz	1a1b	1383007900
	Lug	AC440V	50/60Hz	1a1b	1383008000
	Lug	AC500V	50/60Hz	1a1b	1383008100
	Lug	AC550V	50/60Hz	1a1b	1383008200
	Lug	AC230V	50/60Hz	1a1b	1383008300
	Lug	AC200V	50/60Hz	1a1b	1383008500
	Lug	AC120V	50/60Hz	1a1b	1383008600
	Lug	AC100V	50/60Hz	1a1b	1383008700
	Lug	AC415V	50/60Hz	1a1b	1383008800
	Lug	AC24V	60Hz	1a1b	1383008900
	Lug	AC48V	60Hz	1a1b	1383009000
	Lug	AC110V	60Hz	1a1b	1383009100
	Lug	AC120V	60Hz	1a1b	1383009200
	Lug	AC220V	60Hz	1a1b	1383009300
	Lug	AC240V	60Hz	1a1b	1383009400
	Lug	AC380V	60Hz	1a1b	1383009500
	Lug	AC440V	60Hz	1a1b	1383009600
	Lug	AC480V	60Hz	1a1b	1383009700
	Lug	AC600V	60Hz	1a1b	1383009800
	Lug	AC100V, 110V	50Hz, 60Hz	1a1b	1383009900
	Lug	AC200V, 220V	50Hz, 60Hz	1a1b	1383010000
	Lug	AC208V	60Hz	1a1b	1383010100
	Lug	AC277V	60Hz	1a1b	1383010200
	Lug	AC24V	50Hz	1a1b	1383010300
	Lug	AC48V	50Hz	1a1b	1383010400
	Lug	AC110V	50Hz	1a1b	1383010500
	Lug	AC220V	50Hz	1a1b	1383010600
	Lug	AC240V	50Hz	1a1b	1383010700
	Lug	AC380V	50Hz	1a1b	1383010800
	Lug	AC400V	50Hz	1a1b	1383010900
	Lug	AC415V	50Hz	1a1b	1383011000
	Lug	AC440V	50Hz	1a1b	1383011100
	Lug	AC550V	50Hz	1a1b	1383011200
	Lug	AC36V	50Hz	1a1b	1383011300
	Lug	AC42V	50Hz	1a1b	1383011400
	Lug	AC80V	50Hz	1a1b	1383011500
	Lug	AC100V	50Hz	1a1b	1383011600
	Lug	AC230V	50Hz	1a1b	1383011700
	Lug	AC500V	50Hz	1a1b	1383011800
	Lug	AC32V	50Hz	1a1b	1383011900
	Lug	DC12V	-	1a1b	1383000500
	Lug	DC24V	-	1a1b	1383006300
	Lug	DC48V	-	1a1b	1383006400
Lug	DC100V	-	1a1b	1383006500	
Lug	DC110V	-	1a1b	1383006600	
Lug	DC125V	-	1a1b	1383006700	
Lug	DC200V	-	1a1b	1383006800	
Lug	DC220V	-	1a1b	1383006900	
Lug	DC250V	-	1a1b	1383007000	
Lug	DC20V	-	1a1b	1383007100	
Lug	DC60V	-	1a1b	1383007200	
Lug	DC80V	-	1a1b	1383007300	
Lug	AC24V	50/60Hz	2a2b	1383000600	
Lug	AC48V	50/60Hz	2a2b	1383001800	

Contactors

MC-85a Lug type



100AF

Model	Terminal type	Coil Voltage	Frequency	Aux. Contact	Code
MC-85a	Lug	AC110V	50/60Hz	2a2b	1383001900
	Lug	AC220V	50/60Hz	2a2b	1383002000
	Lug	AC240V	50/60Hz	2a2b	1383002100
	Lug	AC380V	50/60Hz	2a2b	1383002200
	Lug	AC400V	50/60Hz	2a2b	1383002300
	Lug	AC440V	50/60Hz	2a2b	1383002400
	Lug	AC500V	50/60Hz	2a2b	1383002500
	Lug	AC550V	50/60Hz	2a2b	1383002600
	Lug	AC230V	50/60Hz	2a2b	1383002700
	Lug	AC200V	50/60Hz	2a2b	1383002800
	Lug	AC120V	50/60Hz	2a2b	1383002900
	Lug	AC100V	50/60Hz	2a2b	1383003000
	Lug	AC415V	50/60Hz	2a2b	1383003100
	Lug	AC24V	60Hz	2a2b	1383003200
	Lug	AC48V	60Hz	2a2b	1383003300
	Lug	AC110V	60Hz	2a2b	1383003400
	Lug	AC120V	60Hz	2a2b	1383003500
	Lug	AC220V	60Hz	2a2b	1383003600
	Lug	AC240V	60Hz	2a2b	1383003700
	Lug	AC380V	60Hz	2a2b	1383003800
	Lug	AC440V	60Hz	2a2b	1383003900
	Lug	AC480V	60Hz	2a2b	1383004000
	Lug	AC600V	60Hz	2a2b	1383004100
	Lug	AC100V, 110V	50Hz, 60Hz	2a2b	1383004200
	Lug	AC200V, 220V	50Hz, 60Hz	2a2b	1383004300
	Lug	AC208V	60Hz	2a2b	1383004400
	Lug	AC277V	60Hz	2a2b	1383004500
	Lug	AC24V	50Hz	2a2b	1383004600
	Lug	AC48V	50Hz	2a2b	1383004700
	Lug	AC110V	50Hz	2a2b	1383004800
	Lug	AC220V	50Hz	2a2b	1383004900
	Lug	AC240V	50Hz	2a2b	1383005000
	Lug	AC380V	50Hz	2a2b	1383005100
	Lug	AC400V	50Hz	2a2b	1383005200
	Lug	AC415V	50Hz	2a2b	1383005300
	Lug	AC440V	50Hz	2a2b	1383005400
	Lug	AC550V	50Hz	2a2b	1383005500
	Lug	AC36V	50Hz	2a2b	1383005600
	Lug	AC42V	50Hz	2a2b	1383005700
	Lug	AC80V	50Hz	2a2b	1383005800
	Lug	AC100V	50Hz	2a2b	1383005900
	Lug	AC230V	50Hz	2a2b	1383006000
	Lug	AC500V	50Hz	2a2b	1383006100
	Lug	AC32V	50Hz	2a2b	1383006200
	Lug	DC12V	-	2a2b	1383000200
	Lug	DC24V	-	2a2b	1383000700
	Lug	DC48V	-	2a2b	1383000800
Lug	DC100V	-	2a2b	1383000900	
Lug	DC110V	-	2a2b	1383001000	
Lug	DC125V	-	2a2b	1383001100	
Lug	DC200V	-	2a2b	1383001200	
Lug	DC220V	-	2a2b	1383001300	
Lug	DC250V	-	2a2b	1383001400	
Lug	DC20V	-	2a2b	1383001500	
Lug	DC60V	-	2a2b	1383001600	
Lug	DC80V	-	2a2b	1383001700	

Contactors

MC-100a Lug type



100AF

Model	Terminal type	Coil Voltage	Frequency	Aux. Contact	Code
MC-100a	Lug	AC24V	50/60Hz	-	1384000600
	Lug	AC48V	50/60Hz	-	1384013000
	Lug	AC110V	50/60Hz	-	1384013100
	Lug	AC220V	50/60Hz	-	1384013200
	Lug	AC240V	50/60Hz	-	1384013300
	Lug	AC380V	50/60Hz	-	1384013400
	Lug	AC400V	50/60Hz	-	1384013500
	Lug	AC440V	50/60Hz	-	1384013600
	Lug	AC500V	50/60Hz	-	1384013700
	Lug	AC550V	50/60Hz	-	1384013800
	Lug	AC230V	50/60Hz	-	1384013900
	Lug	AC200V	50/60Hz	-	1384014000
	Lug	AC120V	50/60Hz	-	1384014100
	Lug	AC100V	50/60Hz	-	1384014200
	Lug	AC415V	50/60Hz	-	1384014300
	Lug	AC24V	60Hz	-	1384014400
	Lug	AC48V	60Hz	-	1384014500
	Lug	AC110V	60Hz	-	1384014600
	Lug	AC120V	60Hz	-	1384014700
	Lug	AC220V	60Hz	-	1384014800
	Lug	AC240V	60Hz	-	1384014900
	Lug	AC380V	60Hz	-	1384015000
	Lug	AC440V	60Hz	-	1384015100
	Lug	AC480V	60Hz	-	1384015200
	Lug	AC600V	60Hz	-	1384015300
	Lug	AC100V, 110V	50Hz, 60Hz	-	1384015400
	Lug	AC200V, 220V	50Hz, 60Hz	-	1384015500
	Lug	AC208V	60Hz	-	1384015600
	Lug	AC277V	60Hz	-	1384015700
	Lug	AC24V	50Hz	-	1384015800
	Lug	AC48V	50Hz	-	1384015900
	Lug	AC110V	50Hz	-	1384016000
	Lug	AC220V	50Hz	-	1384016100
	Lug	AC240V	50Hz	-	1384016200
	Lug	AC380V	50Hz	-	1384016300
	Lug	AC400V	50Hz	-	1384016400
	Lug	AC415V	50Hz	-	1384016500
	Lug	AC440V	50Hz	-	1384016600
	Lug	AC550V	50Hz	-	1384016700
	Lug	AC36V	50Hz	-	1384016800
	Lug	AC42V	50Hz	-	1384016900
	Lug	AC80V	50Hz	-	1384017000
	Lug	AC100V	50Hz	-	1384017100
	Lug	AC230V	50Hz	-	1384017200
	Lug	AC500V	50Hz	-	1384017300
	Lug	AC32V	50Hz	-	1384017400
	Lug	DC12V	-	-	1384000500
	Lug	DC24V	-	-	1384011900
	Lug	DC48V	-	-	1384012000
	Lug	DC100V	-	-	1384012100
Lug	DC110V	-	-	1384012200	
Lug	DC125V	-	-	1384012300	
Lug	DC200V	-	-	1384012400	
Lug	DC220V	-	-	1384012500	
Lug	DC250V	-	-	1384012600	
Lug	DC20V	-	-	1384012700	
Lug	DC60V	-	-	1384012800	
Lug	DC80V	-	-	1384012900	
Lug	AC24V	50/60Hz	1a1b	1384000400	
Lug	AC48V	50/60Hz	1a1b	1384007400	
Lug	AC110V	50/60Hz	1a1b	1384007500	
Lug	AC220V	50/60Hz	1a1b	1384007600	

Contactors

MC-100a Lug type



100AF

Model	Terminal type	Coil Voltage	Frequency	Aux. Contact	Code
MC-100a	Lug	AC240V	50/60Hz	1a1b	1384007700
	Lug	AC380V	50/60Hz	1a1b	1384007800
	Lug	AC400V	50/60Hz	1a1b	1384007900
	Lug	AC440V	50/60Hz	1a1b	1384008000
	Lug	AC500V	50/60Hz	1a1b	1384008100
	Lug	AC550V	50/60Hz	1a1b	1384008200
	Lug	AC230V	50/60Hz	1a1b	1384008300
	Lug	AC200V	50/60Hz	1a1b	1384008400
	Lug	AC120V	50/60Hz	1a1b	1384008500
	Lug	AC100V	50/60Hz	1a1b	1384008600
	Lug	AC415V	50/60Hz	1a1b	1384008700
	Lug	AC24V	60Hz	1a1b	1384008800
	Lug	AC48V	60Hz	1a1b	1384008900
	Lug	AC110V	60Hz	1a1b	1384009000
	Lug	AC120V	60Hz	1a1b	1384009100
	Lug	AC220V	60Hz	1a1b	1384009200
	Lug	AC240V	60Hz	1a1b	1384009300
	Lug	AC380V	60Hz	1a1b	1384009400
	Lug	AC440V	60Hz	1a1b	1384009500
	Lug	AC480V	60Hz	1a1b	1384009600
	Lug	AC600V	60Hz	1a1b	1384009700
	Lug	AC100V, 110V	50Hz, 60Hz	1a1b	1384009800
	Lug	AC200V, 220V	50Hz, 60Hz	1a1b	1384009900
	Lug	AC208V	60Hz	1a1b	1384010000
	Lug	AC277V	60Hz	1a1b	1384010100
	Lug	AC24V	50Hz	1a1b	1384010200
	Lug	AC48V	50Hz	1a1b	1384010300
	Lug	AC110V	50Hz	1a1b	1384010400
	Lug	AC220V	50Hz	1a1b	1384010500
	Lug	AC240V	50Hz	1a1b	1384010600
	Lug	AC380V	50Hz	1a1b	1384010700
	Lug	AC400V	50Hz	1a1b	1384010800
	Lug	AC415V	50Hz	1a1b	1384010900
	Lug	AC440V	50Hz	1a1b	1384011000
	Lug	AC550V	50Hz	1a1b	1384011100
	Lug	AC36V	50Hz	1a1b	1384011200
	Lug	AC42V	50Hz	1a1b	1384011300
	Lug	AC80V	50Hz	1a1b	1384011400
	Lug	AC100V	50Hz	1a1b	1384011500
	Lug	AC230V	50Hz	1a1b	1384011600
	Lug	AC500V	50Hz	1a1b	1384011700
	Lug	AC32V	50Hz	1a1b	1384011800
	Lug	DC12V	-	1a1b	1384000300
	Lug	DC24V	-	1a1b	1384006300
	Lug	DC48V	-	1a1b	1384006400
Lug	DC100V	-	1a1b	1384006500	
Lug	DC110V	-	1a1b	1384006600	
Lug	DC125V	-	1a1b	1384006700	
Lug	DC200V	-	1a1b	1384006800	
Lug	DC220V	-	1a1b	1384006900	
Lug	DC250V	-	1a1b	1384007000	
Lug	DC20V	-	1a1b	1384007100	
Lug	DC60V	-	1a1b	1384007200	
Lug	DC80V	-	1a1b	1384007300	
Lug	AC24V	50/60Hz	2a2b	1384000200	
Lug	AC48V	50/60Hz	2a2b	1384001800	

Contactors

MC-100a Lug type



100AF

Model	Terminal type	Coil Voltage	Frequency	Aux. Contact	Code
MC-100a	Lug	AC110V	50/60Hz	2a2b	1384001900
	Lug	AC220V	50/60Hz	2a2b	1384002000
	Lug	AC240V	50/60Hz	2a2b	1384002100
	Lug	AC380V	50/60Hz	2a2b	1384002200
	Lug	AC400V	50/60Hz	2a2b	1384002300
	Lug	AC440V	50/60Hz	2a2b	1384002400
	Lug	AC500V	50/60Hz	2a2b	1384002500
	Lug	AC550V	50/60Hz	2a2b	1384002600
	Lug	AC230V	50/60Hz	2a2b	1384002700
	Lug	AC200V	50/60Hz	2a2b	1384002800
	Lug	AC120V	50/60Hz	2a2b	1384002900
	Lug	AC100V	50/60Hz	2a2b	1384003000
	Lug	AC415V	50/60Hz	2a2b	1384003100
	Lug	AC24V	60Hz	2a2b	1384003200
	Lug	AC48V	60Hz	2a2b	1384003300
	Lug	AC110V	60Hz	2a2b	1384003400
	Lug	AC120V	60Hz	2a2b	1384003500
	Lug	AC220V	60Hz	2a2b	1384003600
	Lug	AC240V	60Hz	2a2b	1384003700
	Lug	AC380V	60Hz	2a2b	1384003800
	Lug	AC440V	60Hz	2a2b	1384003900
	Lug	AC480V	60Hz	2a2b	1384004000
	Lug	AC600V	60Hz	2a2b	1384004100
	Lug	AC100V, 110V	50Hz, 60Hz	2a2b	1384004200
	Lug	AC200V, 220V	50Hz, 60Hz	2a2b	1384004300
	Lug	AC208V	60Hz	2a2b	1384004400
	Lug	AC277V	60Hz	2a2b	1384004500
	Lug	AC24V	50Hz	2a2b	1384004600
	Lug	AC48V	50Hz	2a2b	1384004700
	Lug	AC110V	50Hz	2a2b	1384004800
	Lug	AC220V	50Hz	2a2b	1384004900
	Lug	AC240V	50Hz	2a2b	1384005000
	Lug	AC380V	50Hz	2a2b	1384005100
	Lug	AC400V	50Hz	2a2b	1384005200
	Lug	AC415V	50Hz	2a2b	1384005300
	Lug	AC440V	50Hz	2a2b	1384005400
	Lug	AC550V	50Hz	2a2b	1384005500
	Lug	AC36V	50Hz	2a2b	1384005600
	Lug	AC42V	50Hz	2a2b	1384005700
	Lug	AC80V	50Hz	2a2b	1384005800
	Lug	AC100V	50Hz	2a2b	1384005900
	Lug	AC230V	50Hz	2a2b	1384006000
	Lug	AC500V	50Hz	2a2b	1384006100
	Lug	AC32V	50Hz	2a2b	1384006200
	Lug	DC12V	-	2a2b	1384000100
Lug	DC24V	-	2a2b	1384000700	
Lug	DC48V	-	2a2b	1384000800	
Lug	DC100V	-	2a2b	1384000900	
Lug	DC110V	-	2a2b	1384001000	
Lug	DC125V	-	2a2b	1384001100	
Lug	DC200V	-	2a2b	1384001200	
Lug	DC220V	-	2a2b	1384001300	
Lug	DC250V	-	2a2b	1384001400	
Lug	DC20V	-	2a2b	1384001500	
Lug	DC60V	-	2a2b	1384001600	
Lug	DC80V	-	2a2b	1384001700	

Contactors

MC-130a Lug type



150AF

Model	Terminal type	Coil Voltage	Frequency	Aux. Contact	Code
MC-130a	Lug	AC220V	50/60Hz	-	1385000100
	Lug	AC24V	50/60Hz	-	1385000700
	Lug	AC48V	50/60Hz	-	1385000800
	Lug	AC110V	50/60Hz	-	1385000900
	Lug	AC300V	50/60Hz	-	1385001000
	Lug	AC400V	50/60Hz	-	1385001100
	Lug	AC500V	50/60Hz	-	1385001200
	Lug	DC24V	-	-	1385000200
	Lug	DC48V	-	-	1385001300
	Lug	DC110V	-	-	1385001400
	Lug	DC220V	-	-	1385001500
	Lug	AC220V	50/60Hz	1a1b	1385000300
	Lug	AC24V	50/60Hz	1a1b	1385001600
	Lug	AC48V	50/60Hz	1a1b	1385001700
	Lug	AC110V	50/60Hz	1a1b	1385001800
	Lug	AC300V	50/60Hz	1a1b	1385001900
	Lug	AC400V	50/60Hz	1a1b	1385002000
	Lug	AC500V	50/60Hz	1a1b	1385002100
	Lug	DC24V	-	1a1b	1385000400
	Lug	DC48V	-	1a1b	1385002200
	Lug	DC110V	-	1a1b	1385002300
	Lug	DC220V	-	1a1b	1385002400
	Lug	AC220V	50/60Hz	2a2b	1385000500
	Lug	AC24V	50/60Hz	2a2b	1385002500
	Lug	AC48V	50/60Hz	2a2b	1385002600
	Lug	AC110V	50/60Hz	2a2b	1385002700
	Lug	AC300V	50/60Hz	2a2b	1385002800
	Lug	AC400V	50/60Hz	2a2b	1385002900
	Lug	AC500V	50/60Hz	2a2b	1385003000
	Lug	DC24V	-	2a2b	1385000600
	Lug	DC48V	-	2a2b	1385003100
	Lug	DC110V	-	2a2b	1385003200
	Lug	DC220V	-	2a2b	1385003300

Contactors

MC-150a Lug type



150AF

Model	Terminal type	Coil Voltage	Frequency	Aux. Contact	Code
MC-150a	Lug	AC220V	50/60Hz	-	1386000100
	Lug	AC24V	50/60Hz	-	1386000700
	Lug	AC48V	50/60Hz	-	1386000800
	Lug	AC110V	50/60Hz	-	1386000900
	Lug	AC300V	50/60Hz	-	1386001000
	Lug	AC400V	50/60Hz	-	1386001100
	Lug	AC500V	50/60Hz	-	1386001200
	Lug	DC24V	-	-	1386000200
	Lug	DC48V	-	-	1386001300
	Lug	DC110V	-	-	1386001400
	Lug	DC220V	-	-	1386001500
	Lug	AC220V	50/60Hz	1a1b	1386000300
	Lug	AC24V	50/60Hz	1a1b	1386001600
	Lug	AC48V	50/60Hz	1a1b	1386001700
	Lug	AC110V	50/60Hz	1a1b	1386001800
	Lug	AC300V	50/60Hz	1a1b	1386001900
	Lug	AC400V	50/60Hz	1a1b	1386002000
	Lug	AC500V	50/60Hz	1a1b	1386002100
	Lug	DC24V	-	1a1b	1386000400
	Lug	DC48V	-	1a1b	1386002200
	Lug	DC110V	-	1a1b	1386002300
	Lug	DC220V	-	1a1b	1386002400
	Lug	AC220V	50/60Hz	2a2b	1386000500
	Lug	AC24V	50/60Hz	2a2b	1386002500
	Lug	AC48V	50/60Hz	2a2b	1386002600
	Lug	AC110V	50/60Hz	2a2b	1386002700
	Lug	AC300V	50/60Hz	2a2b	1386002800
	Lug	AC400V	50/60Hz	2a2b	1386002900
	Lug	AC500V	50/60Hz	2a2b	1386003000
	Lug	DC24V	-	2a2b	1386000600
	Lug	DC48V	-	2a2b	1386003100
	Lug	DC110V	-	2a2b	1386003200
	Lug	DC220V	-	2a2b	1386003300

Contactors

MT-12 Screw type



18AF

Model	Terminal type	Rated current	Range	Type	Code
MT-12	Screw	5A	4~6	Non-differential(2H)	1318000900
	Screw	6.5A	5~8	Non-differential(2H)	1318001000
	Screw	7.5A	6~9	Non-differential(2H)	1318001100
	Screw	8.5A	7~10	Non-differential(2H)	1318001200
	Screw	11A	9~13	Non-differential(2H)	1318001300
	Screw	15A	12~18	Non-differential(2H)	1318001400
	Screw	0.14A	0.1~0.16	Non-differential(3H)	1319000100
	Screw	0.21A	0.16~0.25	Non-differential(3H)	1319000200
	Screw	0.33A	0.25~0.4	Non-differential(3H)	1319000300
	Screw	0.52A	0.4~0.63	Non-differential(3H)	1319000400
	Screw	0.82A	0.63~1	Non-differential(3H)	1319000500
	Screw	1.3A	1~1.6	Non-differential(3H)	1319000600
	Screw	2.1A	1.6~2.5	Non-differential(3H)	1319000700
	Screw	3.3A	2.5~4	Non-differential(3H)	1319000800
	Screw	5A	4~6	Non-differential(3H)	1319000900
	Screw	6.5A	5~8	Non-differential(3H)	1319001000
	Screw	7.5A	6~9	Non-differential(3H)	1319001100
	Screw	8.5A	7~10	Non-differential(3H)	1319001200
	Screw	11A	9~13	Non-differential(3H)	1319001300
	Screw	15A	12~18	Non-differential(3H)	1319001400
	Screw	0.14A	0.1~0.16	Differential(3K)	1323000100
	Screw	0.21A	0.16~0.25	Differential(3K)	1323000200
	Screw	0.33A	0.25~0.4	Differential(3K)	1323000300
	Screw	0.52A	0.4~0.63	Differential(3K)	1323000400
	Screw	0.82A	0.63~1	Differential(3K)	1323000500
	Screw	1.3A	1~1.6	Differential(3K)	1323000600
	Screw	2.1A	1.6~2.5	Differential(3K)	1323000700
	Screw	3.3A	2.5~4	Differential(3K)	1323000800
	Screw	5A	4~6	Differential(3K)	1323000900
	Screw	6.5A	5~8	Differential(3K)	1323001000
	Screw	7.5A	6~9	Differential(3K)	1323001100
	Screw	8.5A	7~10	Differential(3K)	1323001200
	Screw	11A	9~13	Differential(3K)	1323001300
	Screw	15A	12~18	Differential(3K)	1323002700
	Screw	1.3A	1~1.6	Class 20(3D)	1324000100
	Screw	2.1A	1.6~2.5	Class 20(3D)	1324000200
	Screw	3.3A	2.5~4	Class 20(3D)	1324000300
	Screw	5A	4~6	Class 20(3D)	1324000400
	Screw	6.5A	5~8	Class 20(3D)	1324000500
	Screw	7.5A	6~9	Class 20(3D)	1324000600
	Screw	8.5A	7~10	Class 20(3D)	1324000700
	Screw	11A	9~13	Class 20(3D)	1324000800
Screw	15A	12~18	Class 20(3D)	1324000900	

Contactors

MT-32 Screw type



40AF

Model	Terminal type	Rated current	Range	Type	Code
MT-32	Screw	0.14A	0.1~0.16	Non-differential(2H)	1296000100
	Screw	0.21A	0.16~0.25	Non-differential(2H)	1296000200
	Screw	0.33A	0.25~0.4	Non-differential(2H)	1296000300
	Screw	0.52A	0.4~0.63	Non-differential(2H)	1296000400
	Screw	0.82A	0.63~1	Non-differential(2H)	1296000500
	Screw	1.3A	1~1.6	Non-differential(2H)	1296000600
	Screw	2.1A	1.6~2.5	Non-differential(2H)	1296000700
	Screw	3.3A	2.5~4	Non-differential(2H)	1296000800
	Screw	5A	4~6	Non-differential(2H)	1296000900
	Screw	6.5A	5~8	Non-differential(2H)	1296001000
	Screw	7.5A	6~9	Non-differential(2H)	1296001100
	Screw	8.5A	7~10	Non-differential(2H)	1296001200
	Screw	11A	9~13	Non-differential(2H)	1296001300
	Screw	15A	12~18	Non-differential(2H)	1296001400
	Screw	19A	16~22	Non-differential(2H)	1296001500
	Screw	21.5A	18~25	Non-differential(2H)	1296001600
	Screw	27A	22~32	Non-differential(2H)	1296001700
	Screw	34A	28~40	Non-differential(2H)	1296001800
	Screw	0.14A	0.1~0.16	Non-differential(3H)	1297000100
	Screw	0.21A	0.16~0.25	Non-differential(3H)	1297000200
	Screw	0.33A	0.25~0.4	Non-differential(3H)	1297000300
	Screw	0.52A	0.4~0.63	Non-differential(3H)	1297000400
	Screw	0.82A	0.63~1	Non-differential(3H)	1297000500
	Screw	1.3A	1~1.6	Non-differential(3H)	1297000600
	Screw	2.1A	1.6~2.5	Non-differential(3H)	1297000700
	Screw	3.3A	2.5~4	Non-differential(3H)	1297000800
	Screw	5A	4~6	Non-differential(3H)	1297000900
	Screw	6.5A	5~8	Non-differential(3H)	1297001000
	Screw	7.5A	6~9	Non-differential(3H)	1297001100
	Screw	8.5A	7~10	Non-differential(3H)	1297001200
	Screw	11A	9~13	Non-differential(3H)	1297001300
	Screw	15A	12~18	Non-differential(3H)	1297001400
	Screw	19A	16~22	Non-differential(3H)	1297001500
	Screw	21.5A	18~25	Non-differential(3H)	1297001600
	Screw	27A	22~32	Non-differential(3H)	1297001700
	Screw	34A	28~40	Non-differential(3H)	1297001800
	Screw	0.14A	0.1~0.16	Differential(3K)	1298000100
	Screw	0.21A	0.16~0.25	Differential(3K)	1298000200
	Screw	0.33A	0.25~0.4	Differential(3K)	1298000300
	Screw	0.52A	0.4~0.63	Differential(3K)	1298000400
Screw	0.82A	0.63~1	Differential(3K)	1298000500	
Screw	1.3A	1~1.6	Differential(3K)	1298000600	
Screw	2.1A	1.6~2.5	Differential(3K)	1298000700	
Screw	3.3A	2.5~4	Differential(3K)	1298000800	
Screw	5A	4~6	Differential(3K)	1298000900	
Screw	6.5A	5~8	Differential(3K)	1298001000	
Screw	7.5A	6~9	Differential(3K)	1298001100	
Screw	8.5A	7~10	Differential(3K)	1298001200	
Screw	11A	9~13	Differential(3K)	1298001300	
Screw	15A	12~18	Differential(3K)	1298001400	
Screw	19A	16~22	Differential(3K)	1298001500	
Screw	21.5A	18~25	Differential(3K)	1298001600	
Screw	27A	22~32	Differential(3K)	1298001700	
Screw	34A	28~40	Differential(3K)	1298002000	
Screw	1.3	1~1.6	Class 20(3D)	1299000100	
Screw	2.1	1.6~2.5	Class 20(3D)	1299000200	
Screw	3.3	2.5~4	Class 20(3D)	1299000300	
Screw	5	4~6	Class 20(3D)	1299000400	
Screw	6.5	5~8	Class 20(3D)	1299000500	
Screw	7.5	6~9	Class 20(3D)	1299000600	
Screw	8.5	7~10	Class 20(3D)	1299000700	
Screw	11	9~13	Class 20(3D)	1299000800	
Screw	15	12~18	Class 20(3D)	1299000900	
Screw	19	16~22	Class 20(3D)	1299001000	
Screw	21.5	18~25	Class 20(3D)	1299001100	
Screw	27	22~32	Class 20(3D)	1299001200	
Screw	34	28~40	Class 20(3D)	1299001300	

Contactors

MT-63 Screw type



65AF

Model	Terminal type	Rated current	Range	Type	Code
MT-63	Screw	5	4-6	Non-differential(2H)	1308000100
	Screw	6.5	5-8	Non-differential(2H)	1308000200
	Screw	7.5	6-9	Non-differential(2H)	1308000300
	Screw	8.5	7~10	Non-differential(2H)	1308000400
	Screw	11	9~13	Non-differential(2H)	1308000500
	Screw	15	12-18	Non-differential(2H)	1308000600
	Screw	19	16-22	Non-differential(2H)	1308000700
	Screw	21.5	18-25	Non-differential(2H)	1308000800
	Screw	30	24-36	Non-differential(2H)	1308000900
	Screw	34	28-40	Non-differential(2H)	1308001000
	Screw	42	34-50	Non-differential(2H)	1308001100
	Screw	54	45-65	Non-differential(2H)	1308001200
	Screw	5	4-6	Non-differential(3H)	1309000100
	Screw	6.5	5-8	Non-differential(3H)	1309000200
	Screw	7.5	6-9	Non-differential(3H)	1309000300
	Screw	8.5	7~10	Non-differential(3H)	1309000400
	Screw	11	9~13	Non-differential(3H)	1309000500
	Screw	15	12-18	Non-differential(3H)	1309000600
	Screw	19	16-22	Non-differential(3H)	1309000700
	Screw	21.5	18-25	Non-differential(3H)	1309000800
	Screw	30	24-36	Non-differential(3H)	1309000900
	Screw	34	28-40	Non-differential(3H)	1309001000
	Screw	42	34-50	Non-differential(3H)	1309001100
	Screw	54	45-65	Non-differential(3H)	1309001200
	Screw	5	4-6	Differential(3K)	1310000100
	Screw	6.5	5-8	Differential(3K)	1310000200
	Screw	7.5	6-9	Differential(3K)	1310000300
	Screw	8.5	7~10	Differential(3K)	1310000400
	Screw	11	9~13	Differential(3K)	1310000500
	Screw	15	12-18	Differential(3K)	1310000600
	Screw	19	16-22	Differential(3K)	1310000700
	Screw	21.5	18-25	Differential(3K)	1310000800
	Screw	30	24-36	Differential(3K)	1310000900
	Screw	34	28-40	Differential(3K)	1310001000
	Screw	42	34-50	Differential(3K)	1310001100
	Screw	54	45-65	Differential(3K)	1310001200
Screw	5	4-6	Class 20(3D)	1311000100	
Screw	6.5	5-8	Class 20(3D)	1311000200	
Screw	7.5	6-9	Class 20(3D)	1311000300	
Screw	8.5	7~10	Class 20(3D)	1311000400	
Screw	11	9~13	Class 20(3D)	1311000500	
Screw	15	12-18	Class 20(3D)	1311000600	
Screw	19	16-22	Class 20(3D)	1311000700	
Screw	21.5	18-25	Class 20(3D)	1311000800	
Screw	30	24-36	Class 20(3D)	1311000900	
Screw	34	28-40	Class 20(3D)	1311001000	
Screw	42	34-50	Class 20(3D)	1311001100	
Screw	54	45-65	Class 20(3D)	1311001200	

Contactors

MT-63 Lug type



65AF

Model	Terminal type	Rated current	Range	Type	Code
MT-63	Lug	5	4~6	Non-differential(2H)	13000001
	Lug	6.5	5~8	Non-differential(2H)	13000002
	Lug	7.5	6~9	Non-differential(2H)	13000003
	Lug	8.5	7~10	Non-differential(2H)	13000004
	Lug	11	9~13	Non-differential(2H)	13000005
	Lug	15	12~18	Non-differential(2H)	13000006
	Lug	19	16~22	Non-differential(2H)	13000007
	Lug	21.5	18~25	Non-differential(2H)	13000008
	Lug	30	24~36	Non-differential(2H)	13000009
	Lug	34	28~40	Non-differential(2H)	13000010
	Lug	42	34~50	Non-differential(2H)	13000011
	Lug	55	45~65	Non-differential(2H)	13000012
	Lug	5	4~6	Non-differential(3H)	13010001
	Lug	6.5	5~8	Non-differential(3H)	13010002
	Lug	7.5	6~9	Non-differential(3H)	13010003
	Lug	8.5	7~10	Non-differential(3H)	13010004
	Lug	11	9~13	Non-differential(3H)	13010005
	Lug	15	12~18	Non-differential(3H)	13010006
	Lug	19	16~22	Non-differential(3H)	13010007
	Lug	21.5	18~25	Non-differential(3H)	13010008
	Lug	30	24~36	Non-differential(3H)	13010009
	Lug	34	28~40	Non-differential(3H)	13010010
	Lug	42	34~50	Non-differential(3H)	13010011
	Lug	55	45~65	Non-differential(3H)	13010012
	Lug	5	4~6	Differential(3K)	13020001
	Lug	6.5	5~8	Differential(3K)	13020002
	Lug	7.5	6~9	Differential(3K)	13020003
	Lug	8.5	7~10	Differential(3K)	13020004
	Lug	11	9~13	Differential(3K)	13020005
	Lug	15	12~18	Differential(3K)	13020006
	Lug	19	16~22	Differential(3K)	13020007
	Lug	21.5	18~25	Differential(3K)	13020008
	Lug	30	24~36	Differential(3K)	13020009
	Lug	34	28~40	Differential(3K)	13020010
	Lug	42	34~50	Differential(3K)	13020011
	Lug	55	45~65	Differential(3K)	13020012
	Lug	5	4~6	Class 20(3D)	13030001
	Lug	6.5	5~8	Class 20(3D)	13030002
	Lug	7.5	6~9	Class 20(3D)	13030003
	Lug	8.5	7~10	Class 20(3D)	13030004
	Lug	11	9~13	Class 20(3D)	13030005
	Lug	15	12~18	Class 20(3D)	13030006
Lug	19	16~22	Class 20(3D)	13030007	
Lug	21.5	18~25	Class 20(3D)	13030008	
Lug	30	24~36	Class 20(3D)	13030009	
Lug	34	28~40	Class 20(3D)	13030010	
Lug	42	34~50	Class 20(3D)	13030011	
Lug	55	45~65	Class 20(3D)	13030012	

Contactors

MT-95 Screw type



65AF

Model	Terminal type	Rated current	Range	Type	Code
MT-95	Screw	8.5	7~10	Non-differential(2H)	1312000100
	Screw	11	9~13	Non-differential(2H)	1312000200
	Screw	15	12~18	Non-differential(2H)	1312000300
	Screw	19	16~22	Non-differential(2H)	1312000400
	Screw	21.5	18~25	Non-differential(2H)	1312000500
	Screw	30	24~36	Non-differential(2H)	1312000600
	Screw	34	28~40	Non-differential(2H)	1312000700
	Screw	42	34~50	Non-differential(2H)	1312000800
	Screw	54	45~65	Non-differential(2H)	1312000900
	Screw	65	54~75	Non-differential(2H)	1312001000
	Screw	74	63~85	Non-differential(2H)	1312001100
	Screw	83	70~95	Non-differential(2H)	1312001200
	Screw	90	80~100	Non-differential(2H)	1312001300
	Screw	8.5	7~10	Non-differential(3H)	1313000100
	Screw	11	9~13	Non-differential(3H)	1313000200
	Screw	15	12~18	Non-differential(3H)	1313000300
	Screw	19	16~22	Non-differential(3H)	1313000400
	Screw	21.5	18~25	Non-differential(3H)	1313000500
	Screw	30	24~36	Non-differential(3H)	1313000600
	Screw	34	28~40	Non-differential(3H)	1313000700
	Screw	42	34~50	Non-differential(3H)	1313000800
	Screw	54	45~65	Non-differential(3H)	1313000900
	Screw	65	54~75	Non-differential(3H)	1313001000
	Screw	74	63~85	Non-differential(3H)	1313001100
	Screw	83	70~95	Non-differential(3H)	1313001200
	Screw	90	80~100	Non-differential(3H)	1313001300
	Screw	8.5	7~10	Differential(3K)	1314000100
	Screw	11	9~13	Differential(3K)	1314000200
	Screw	15	12~18	Differential(3K)	1314000300
	Screw	19	16~22	Differential(3K)	1314000400
	Screw	21.5	18~25	Differential(3K)	1314000500
	Screw	30	24~36	Differential(3K)	1314000600
	Screw	34	28~40	Differential(3K)	1314000700
	Screw	42	34~50	Differential(3K)	1314000800
	Screw	54	45~65	Differential(3K)	1314000900
	Screw	65	54~75	Differential(3K)	1314001000
	Screw	74	63~85	Differential(3K)	1314001100
	Screw	83	70~95	Differential(3K)	1314001200
	Screw	90	80~100	Differential(3K)	1314001300
	Screw	8.5	7~10	Class 20(3D)	1315000100
	Screw	11	9~13	Class 20(3D)	1315000200
	Screw	15	12~18	Class 20(3D)	1315000300
Screw	19	16~22	Class 20(3D)	1315000400	
Screw	21.5	18~25	Class 20(3D)	1315000500	
Screw	30	24~36	Class 20(3D)	1315000600	
Screw	34	28~40	Class 20(3D)	1315000700	
Screw	42	34~50	Class 20(3D)	1315000800	
Screw	54	45~65	Class 20(3D)	1315000900	
Screw	65	54~75	Class 20(3D)	1315001000	
Screw	74	63~85	Class 20(3D)	1315001100	
Screw	83	70~95	Class 20(3D)	1315001200	
Screw	90	80~100	Class 20(3D)	1315001300	

Contactors

MT-95 Lug type



65AF

Model	Terminal type	Rated current	Range	Type	Code
MT-95	Lug	8.5	7~10	Non-differential(2H)	13040001
	Lug	11	9~13	Non-differential(2H)	13040002
	Lug	15	12~18	Non-differential(2H)	13040003
	Lug	19	16~22	Non-differential(2H)	13040004
	Lug	21.5	18~25	Non-differential(2H)	13040005
	Lug	30	24~36	Non-differential(2H)	13040006
	Lug	34	28~40	Non-differential(2H)	13040007
	Lug	42	34~50	Non-differential(2H)	13040008
	Lug	54	45~65	Non-differential(2H)	13040009
	Lug	65	54~75	Non-differential(2H)	13040010
	Lug	74	63~85	Non-differential(2H)	13040011
	Lug	83	70~95	Non-differential(2H)	13040012
	Lug	90	80~100	Non-differential(2H)	13040013
	Lug	8.5	7~10	Non-differential(3H)	13050001
	Lug	11	9~13	Non-differential(3H)	13050002
	Lug	15	12~18	Non-differential(3H)	13050003
	Lug	19	16~22	Non-differential(3H)	13050004
	Lug	21.5	18~25	Non-differential(3H)	13050005
	Lug	30	24~36	Non-differential(3H)	13050006
	Lug	34	28~40	Non-differential(3H)	13050007
	Lug	42	34~50	Non-differential(3H)	13050008
	Lug	54	45~65	Non-differential(3H)	13050009
	Lug	65	54~75	Non-differential(3H)	13050010
	Lug	74	63~85	Non-differential(3H)	13050011
	Lug	83	70~95	Non-differential(3H)	13050012
	Lug	90	80~100	Non-differential(3H)	13050013
	Lug	8.5	7~10	Differential(3K)	13060001
	Lug	11	9~13	Differential(3K)	13060002
	Lug	15	12~18	Differential(3K)	13060003
	Lug	19	16~22	Differential(3K)	13060004
	Lug	21.5	18~25	Differential(3K)	13060005
	Lug	30	24~36	Differential(3K)	13060006
	Lug	34	28~40	Differential(3K)	13060007
	Lug	42	34~50	Differential(3K)	13060008
	Lug	54	45~65	Differential(3K)	13060009
	Lug	65	54~75	Differential(3K)	13060010
	Lug	74	63~85	Differential(3K)	13060011
	Lug	83	70~95	Differential(3K)	13060012
	Lug	90	80~100	Differential(3K)	13060013
	Lug	8.5	7~10	Class 20(3D)	13070001
	Lug	11	9~13	Class 20(3D)	13070002
	Lug	15	12~18	Class 20(3D)	13070003
Lug	19	16~22	Class 20(3D)	13070004	
Lug	21.5	18~25	Class 20(3D)	13070005	
Lug	30	24~36	Class 20(3D)	13070006	
Lug	34	28~40	Class 20(3D)	13070007	
Lug	42	34~50	Class 20(3D)	13070008	
Lug	54	45~65	Class 20(3D)	13070009	
Lug	65	54~75	Class 20(3D)	13070010	
Lug	74	63~85	Class 20(3D)	13070011	
Lug	83	70~95	Class 20(3D)	13070012	
Lug	90	80~100	Class 20(3D)	13070013	

Contactors

MT-150 Screw / Lug type



65AF

Model	Terminal type	Rated current	Range	Type	Code
MT-150	Screw	42A	34-50	Non-differential(2H)	1375000100
	Screw	55A	45-65	Non-differential(2H)	1375000200
	Screw	65A	54-75	Non-differential(2H)	1375000300
	Screw	74A	63-85	Non-differential(2H)	1375000400
	Screw	93A	80-105	Non-differential(2H)	1375000500
	Screw	113A	95-130	Non-differential(2H)	1375000600
	Screw	130A	110-150	Non-differential(2H)	1375000700
	Screw	42A	34-50	Non-differential(3H)	1375000800
	Screw	55A	45-65	Non-differential(3H)	1375000900
	Screw	65A	54-75	Non-differential(3H)	1375001000
	Screw	74A	63-85	Non-differential(3H)	1375001100
	Screw	93A	80-105	Non-differential(3H)	1375001200
	Screw	113A	95-130	Non-differential(3H)	1375001300
	Screw	130A	110-150	Non-differential(3H)	1375001400
	Screw	42A	34-50	Differential(3K)	1375001500
	Screw	55A	45-65	Differential(3K)	1375001600
	Screw	65A	54-75	Differential(3K)	1375001700
	Screw	74A	63-85	Differential(3K)	1375001800
	Screw	93A	80-105	Differential(3K)	1375001900
	Screw	113A	95-130	Differential(3K)	1375002000
	Screw	130A	110-150	Differential(3K)	1375002100
	Screw	42A	34-50	Class 20(3D)	1375002200
	Screw	55A	45-65	Class 20(3D)	1375002300
	Screw	65A	54-75	Class 20(3D)	1375002400
	Screw	74A	63-85	Class 20(3D)	1375002500
	Screw	93A	80-105	Class 20(3D)	1375002600
	Screw	113A	95-130	Class 20(3D)	1375002700
	Screw	130A	110-150	Class 20(3D)	1375002800
	Lug	42A	34-50	Non-differential(2H)	1375002900
	Lug	55A	45-65	Non-differential(2H)	1375003000
	Lug	65A	54-75	Non-differential(2H)	1375003100
	Lug	74A	63-85	Non-differential(2H)	1375003200
	Lug	93A	80-105	Non-differential(2H)	1375003300
	Lug	113A	95-130	Non-differential(2H)	1375003400
	Lug	130A	110-150	Non-differential(2H)	1375003500
	Lug	42A	34-50	Non-differential(3H)	1375003600
	Lug	55A	45-65	Non-differential(3H)	1375003700
	Lug	65A	54-75	Non-differential(3H)	1375003800
	Lug	74A	63-85	Non-differential(3H)	1375003900
	Lug	93A	80-105	Non-differential(3H)	1375004000
	Lug	113A	95-130	Non-differential(3H)	1375004100
	Lug	130A	110-150	Non-differential(3H)	1375004200
	Lug	42A	34-50	Differential(3K)	1375004300
	Lug	55A	45-65	Differential(3K)	1375004400
	Lug	65A	54-75	Differential(3K)	1375004500
	Lug	74A	63-85	Differential(3K)	1375004600
	Lug	93A	80-105	Differential(3K)	1375004700
	Lug	113A	95-130	Differential(3K)	1375004800
Lug	130A	110-150	Differential(3K)	1375004900	
Lug	42A	34-50	Class 20(3D)	1375005000	
Lug	55A	45-65	Class 20(3D)	1375005100	
Lug	65A	54-75	Class 20(3D)	1375005200	
Lug	74A	63-85	Class 20(3D)	1375005300	
Lug	93A	80-105	Class 20(3D)	1375005400	
Lug	113A	95-130	Class 20(3D)	1375005500	
Lug	130A	110-150	Class 20(3D)	1375005600	

Contactors

MT-225 ~ MT-800 Screw type

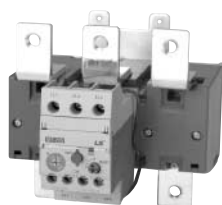

225AF

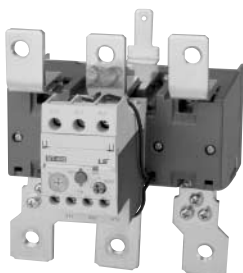

400AF

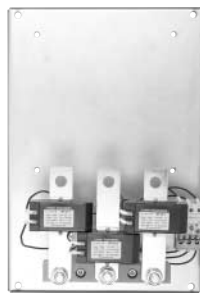

80AF

Model	Terminal type	Rated current	Range	Type	Code
MT-225	Screw	80A	65~100	Non-differential(2H)	1377000100
	Screw	107A	85~125	Non-differential(2H)	1377000200
	Screw	130A	100~160	Non-differential(2H)	1377000300
	Screw	153A	120~185	Non-differential(2H)	1377000400
	Screw	200A	160~240	Non-differential(2H)	1377000500
	Screw	80A	65~100	Non-differential(3H)	1377000600
	Screw	107A	85~125	Non-differential(3H)	1377000700
	Screw	130A	100~160	Non-differential(3H)	1377000800
	Screw	153A	120~185	Non-differential(3H)	1377000900
	Screw	200A	160~240	Non-differential(3H)	1377001000
	Screw	80A	65~100	Differential(3K)	1377001100
	Screw	107A	85~125	Differential(3K)	1377001200
	Screw	130A	100~160	Differential(3K)	1377001300
	Screw	153A	120~185	Differential(3K)	1377001400
	Screw	200A	160~240	Differential(3K)	1377001500
	Screw	80A	65~100	Class 20(3D)	1377001600
	Screw	107A	85~125	Class 20(3D)	1377001700
	Screw	130A	100~160	Class 20(3D)	1377001800
	Screw	153A	120~185	Class 20(3D)	1377001900
	Screw	200A	160~240	Class 20(3D)	1377002000
MT-400	Screw	107A	85~125	Non-differential(2H)	1378000100
	Screw	130A	100~160	Non-differential(2H)	1378000200
	Screw	153A	120~185	Non-differential(2H)	1378000300
	Screw	200A	160~240	Non-differential(2H)	1378000400
	Screw	265A	200~330	Non-differential(2H)	1378000500
	Screw	350A	260~400	Non-differential(2H)	1378000600
	Screw	107A	85~125	Non-differential(3H)	1378000700
	Screw	130A	100~160	Non-differential(3H)	1378000800
	Screw	153A	120~185	Non-differential(3H)	1378000900
	Screw	200A	160~240	Non-differential(3H)	1378001000
	Screw	265A	200~330	Non-differential(3H)	1378001100
	Screw	350A	260~400	Non-differential(3H)	1378001200
	Screw	107A	85~125	Differential(3K)	1378001300
	Screw	130A	100~160	Differential(3K)	1378001400
	Screw	153A	120~185	Differential(3K)	1378001500
	Screw	200A	160~240	Differential(3K)	1378001600
	Screw	265A	200~330	Differential(3K)	1378001700
	Screw	350A	260~400	Differential(3K)	1378001800
	Screw	107A	85~125	Class 20(3D)	1378001900
	Screw	130A	100~160	Class 20(3D)	1378002000
Screw	153A	120~185	Class 20(3D)	1378002100	
Screw	200A	160~240	Class 20(3D)	1378002200	
Screw	265A	200~330	Class 20(3D)	1378002300	
Screw	350A	260~400	Class 20(3D)	1378002400	
MT-800	Screw	265A	200~330	Non-differential(2H)	1379000100
	Screw	350A	260~400	Non-differential(2H)	1379000200
	Screw	515A	400~630	Non-differential(2H)	1379000300
	Screw	660A	520~800	Non-differential(2H)	1379000400
	Screw	265A	200~330	Non-differential(3H)	1379000500
	Screw	350A	260~400	Non-differential(3H)	1379000600
	Screw	515A	400~630	Non-differential(3H)	1379000700
	Screw	660A	520~800	Non-differential(3H)	1379000800
	Screw	265A	200~330	Differential(3K)	1379000900
	Screw	350A	260~400	Differential(3K)	1379001000
	Screw	515A	400~630	Differential(3K)	1379001100
	Screw	660A	520~800	Differential(3K)	1379001200
	Screw	265A	200~330	Class 20(3D)	1379001300
	Screw	350A	260~400	Class 20(3D)	1379001400
Screw	515A	400~630	Class 20(3D)	1379001500	
Screw	660A	520~800	Class 20(3D)	1379001600	

Direct adapter

Type	Model	Description	Applied products	Code
Direct adapter	DA-16SA	Adapter, MINI, AC, DA-16SA	GMC-6M~16M	73311941001
	DA-16SD	Adapter, MINI, DC, DA-16SD	GMD-6M~16M	73311941002
	DA-16HA	Adapter, MINI, AC, DA-16HA	GMC-6M~16M	73311941003
	DA-16HD	Adapter, MINI, DC, DA-16HD	GMD-6M~16M	73311941004
	DA-18SA	Adapter, AC, DA-18SA, EXP	MC-6a~18a AC	73311634051
	DA-18SD	Adapter, DC, DA-18SD, EXP	MC-6a~18a DC	73311634053
	DA-18HA	Adapter, AC, DA-18HA, EXP	MC-6a~18a AC	73311634052
	DA-18HD	Adapter, DC, DA-18HD, EXP	MC-6a~18a DC	73311634054
	DA-22SA	Adapter, AC, DA-22SA	MC-9b~22b AC	73311634055
	DA-22SD	Adapter, AC, DA-22SD	MC-9b~22b DC	73311634057
	DA-22HA	Adapter, AC, DA-22HA	MC-9b~22b AC	73311634056
	DA-22HD	Adapter, AC, DA-22HD	MC-9b~22b DC	73311634058
	DA-32SA	Adapter, AC, DA-32SA	MC-32a~40a AC	73311634001
	DA-32SD	Adapter, DC, DA-32SD	MC-32a~40a DC	73311634003
	DA-32HA	Adapter, AC, DA-32HA	MC-32a~40a AC	73311634002
	DA-32HD	Adapter, DC, DA-32HD	MC-32a~40a DC	73311634004
	DA-63A	Adapter, AC, DA-63A	MC-50a~65a AC Lug	73311634005
	DA-63D	Adapter, DC, DA-63D	MC-50a~65a DC Lug	73311634006
DA-95A	Adapter, AC, DA-95A	MC-75a~100a AC Lug	73311634007	
DA-95D	Adapter, DC, DA-95D	MC-75a~100a DC Lug	73311634008	

Surge unit



Model	Terminal type	Rated current	Type	Code
Surge Unit	US-1	AC24~48V	MC-6a~150a	83611634001
	US-2	AC100~125V	MC-6a~150a	83611634002
	US-3	AC200~240V	MC-6a~150a	83611634003
	US-4	DC24~48V	MC-6a~150a	83611634004
	US-5	DC100~125V	MC-6a~150a	83611634005
	US-6	DC200~220V	MC-6a~150a	83611634006
	US-11	AC/DC24~48V	MC-6a~150a	83611634007
	US-12	AC/DC100~125V	MC-6a~150a	83611634008
	US-13	AC/DC200~240V	MC-6a~150a	83611634009
	US-14	AC380~440V	MC-6a~150a	83611634010
	US-22	AC100~125V	MC-6a~150a	83611634011

Aux. Contact unit

Type	Model	Discription		Applied products	Code
Aux. Contact Unit	UA-1	1A1B	1NO 1NC	MC-6a~150a	83361634001
	AU-2	2A	2NO	MC-6a~150a	83361611028
		1A1B	1NO 1NC	MC-6a~150a	83361611030
	AU-4	2B	2NC	MC-6a~150a	83361611032
		4A	4NO	MC-6a~150a	83361611054
		3A1B	3NO 1NC	MC-6a~150a	83361611056
		2A2B	2NO 2NC	MC-6a~150a	83361611058
		1A3B	1NO 3NC	MC-6a~150a	83361611060
		4B	4NC	MC-6a~150a	83361611062
	AU-100	1A1B	1NO 1NC	MC-185a~800a	83361614009
	AU-100E	1A1B	1NO 1NC	MC-185a~800a	83361614016

Wire Ass'y

Type	Model	Description	Applied product	Code
Wire Ass'y	UW-18	-	MC-6aR~18aR	76671635003
	UW-22	-	MC-9bR~22bR	76671636003
	UW-32	-	MC-32aR, 40aR	76671631003
	UW-63	-	MC-50aR, 65aR	76671632003
	UW-95	-	MC-75aR~100aR	76671633003

Delay open device

Type	Model	Description	Applied product	Code
Delay open device	AD-9	AC220V	MC-6a~40a	83391611001
	AD-9	AC110V	MC-6a~40a	83391611002
	AD-50	AC220V	MC-50a~100a	83391613030
	AD-50	AC110V	MC-50a~100a	83391613031
	AD-100	AC100~240V	MC-130a~225a	83391614002
	AD-300	AC100~240V	MC-265a~400a	83391617001
	AD-600	AC100~127V	MC-500a~800a	83391618001
	AD-600	AC200~240V	MC-500a~800a	83391618002

Catalogue numbers

Interlok unit



Type	Model	Description	Applied product	Code
Interlok Unit	UR-02	2NC	MC-6a~150a	83411634001
	AR-180	HORIZONTAL	MC-185a~400a	83411616001
	AR-600	HORIZONTAL	MC-500a~800a	56121618001
	AR-600	VERTICAL	MC-500a~800a	56121618002

Capacitor unit



Type	Model	Description	Applied product	Code
Capacitor Unit	AC-9	-	MC-6a~40a	83631611001
	AC-50	-	MC-50a~100a	83631613001

Remote reset



Type	Model	Description	Applied product	Code
Remote reset	UM-4R	400mm	MT-32~150	84581831001
	UM-5R	500mm	MT-32~150	84581831002
	UM-6R	600mm	MT-32~150	84581831003

Separate mounting adapter



Type	Model	Description	Applied priduct	Code
Separate mounting adapter	AZ-12MH	-	GTH(K)-12M	83661821001
	UZ-32	-	MT-32	83661831001
	UZ-63/S	-	MT-63	83661832002
	UZ-95/S	-	MT-95	83661833002
	UZ-150/S	-	MT-150	83661835002

Lug Ass'y terminal

Type	Model	Description	Applied priduct	Code
Lug Ass'y Terminal	AJ-220	-	MC-185a, 225a	70821616008
	AJ-400	-	MC-265a~400a	70821617008
	AJ-800	-	MC-500a~800a	70821618008

Capacitor unit



Type	Model	Description	Applied priduct	Code
Safety Cover	-	-	MC-6a~150a	64611611205
	-	-	MC-185a~800a	64611642002

Catalogue numbers

Latch unit

Type	Model	Rated current	Applied product	Description	Code
Latch unit	AL-9	AC24V	MC-6a~40a	-	83461611007
	AL-9	AC100V	MC-6a~40a	-	83461611004
	AL-9	AC200V	MC-6a~40a	-	83461611006
	AL-9	AC300V	MC-6a~40a	-	83461611009
	AL-9	AC400V	MC-6a~40a	-	83461611011
	AL-9	AC500V	MC-6a~40a	-	83461611013
	AL-9	DC24V	MC-6a~40a	-	83461611024
	AL-9	DC48V	MC-6a~40a	-	83461611026
	AL-9	DC100V	MC-6a~40a	-	83461611016
	AL-9	DC125V	MC-6a~40a	-	83461611018
	AL-9	DC12V	MC-6a~40a	-	83461611020
	AL-9	DC200V	MC-6a~40a	-	83461611022
	AL-50	AC24V	MC-50a, 65a	-	83461613006
	AL-50	AC48V	MC-50a, 65a	-	83461613014
	AL-50	AC100V	MC-50a, 65a	-	83461613003
	AL-50	AC200V	MC-50a, 65a	-	83461613004
	AL-50	AC300V	MC-50a, 65a	-	83461613008
	AL-50	AC400V	MC-50a, 65a	-	83461613010
	AL-50	AC500V	MC-50a, 65a	-	83461613012
	AL-50	DC24V	MC-50a, 65a	-	83461613074
	AL-50	DC100V	MC-50a, 65a	-	83461613016
	AL-95	AC24V	MC-75a~150a	-	83461634001
	AL-95	AC48V	MC-75a~150a	-	83461634002
	AL-95	AC100V	MC-75a~150a	-	83461634003
	AL-95	AC200V	MC-75a~150a	-	83461634004
	AL-95	AC300V	MC-75a~150a	-	83461634005
	AL-95	AC400V	MC-75a~150a	-	83461634006
	AL-95	AC500V	MC-75a~150a	-	83461634007
	AL-95	DC12V	MC-75a~150a	-	83461634008
	AL-95	DC24V	MC-75a~150a	-	83461634009
	AL-95	DC48V	MC-75a~150a	-	83461634010
	AL-95	DC100V	MC-75a~150a	-	83461634011
	AL-95	DC125V	MC-75a~150a	-	83461634012
	AL-95	DC200V	MC-75a~150a	-	83461634013
	AL-200	AC100V	MC-185a, 225a	Base, Latch, GMC-180L/220L	64261616001
				Guide, Latch, GMC-180L/220L	55111616002
				Spacer, Latch, GMC-100L~400L	61461614001
				Latch Ass'Y, AC100V, GMC-180L/220L	65221616001
	AL-200	AC200V	MC-185a, 225a	Base, Latch, GMC-180L/220L	64261616001
				Guide, Latch, GMC-180L/220L	55111616002
				Spacer, Latch, GMC-100L~400L	61461614001
				Latch Ass'Y, AC200V, GMC-180L/220L	65221616003
AL-400	AC100V	MC-265a~400a	Base, Latch, GMC-300L/400L	64261617001	
			Guide, Latch, GMC-300L/400L	55111617002	
			Spacer, Latch, GMC-100L~400L	61461614001	
			Latch Ass'Y, AC100V, GMC-300L/400L	65221617001	
AL-400	AC200V	MC-265a~400a	Base, Latch, GMC-300L/400L	64261617001	
			Guide, Latch, GMC-300L/400L	55111617002	
			Spacer, Latch, GMC-100L~400L	61461614001	
			Latch Ass'Y, AC200V, GMC-300L/400L	65221617003	

Timer

Type	Model	Rated voltage	Applied product	Code
Timer	UT-1N	AC/DC24~48V	MC-9a~150a	83391634001
	UT-2N	AC110~220V		83391634002
	UT-1F	AC/DC24~48V		83391634003
	UT-2F	AC110~220V		83391634004

Cover

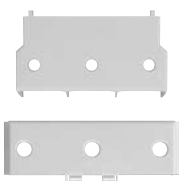

Type	Model	Applied product	Code
Terminal cover unit for contactor	AP-220	MC-185a, 225a	64611614006
	AP-400	MC-265a~400a	64611614007
	AP-800	MC-500a~800a	64611614008



Type	Model	Applied product	Code
Terminal cover unit for TOR	APT-220	MT-225	64611816005
	APT-400	MT-400	64611817015



Type	Model	Applied product	Code
Insulation barrier units	AI-180	MC-185a~400a	83511616001
	AI-800	MC-500a~800a	83511618001

3-pole AC operating Mini Contactors (6~16A)



Model	Coil Voltage (V)	Hz	No. of Auxiliary Contact	Catalogue No.
GMC-6M	AC24V	50/60Hz	1a	1269022800
	AC36V	50/60Hz	1a	1269022900
	AC42V	50/60Hz	1a	1269023000
	AC48V	50/60Hz	1a	1269023100
	AC110V	50/60Hz	1a	1269023200
	AC115V	50/60Hz	1a	1269023300
	AC120V	50/60Hz	1a	1269023400
	AC127V	50/60Hz	1a	1269023500
	AC200V	50/60Hz	1a	1269034400
	AC220V	50/60Hz	1a	1269023700
	AC240V	50/60Hz	1a	1269037500
	AC256V	50/60Hz	1a	1269024000
	AC277V	50/60Hz	1a	1269024100
	AC380V	50/60Hz	1a	1269032900
	AC400V	50/60Hz	1a	1269024300
	AC440V	50/60Hz	1a	1269024400
	AC480V	50/60Hz	1a	1269024500
	AC500V	50/60Hz	1a	1269024600
	AC550V	50/60Hz	1a	1269024700
	AC24V	50/60Hz	1b	1269002100
	AC36V	50/60Hz	1b	1269002200
	AC42V	50/60Hz	1b	1269002300
	AC48V	50/60Hz	1b	1269002400
	AC110V	50/60Hz	1b	1269002500
	AC115V	50/60Hz	1b	1269002600
	AC120V	50/60Hz	1b	1269002700
	AC127V	50/60Hz	1b	1269002800
	AC200V	50/60Hz	1b	1269037600
	AC220V	50/60Hz	1b	1269003000
	AC240V	50/60Hz	1b	1269037700
	AC256V	50/60Hz	1b	1269003300
	AC277V	50/60Hz	1b	1269003400
	AC380V	50/60Hz	1b	1269033000
	AC400V	50/60Hz	1b	1269003600
AC440V	50/60Hz	1b	1269003700	
AC480V	50/60Hz	1b	1269003800	
AC500V	50/60Hz	1b	1269003900	
AC550V	50/60Hz	1b	1269004000	
GMC-9M	AC24V	50/60Hz	1a	1269008100
	AC36V	50/60Hz	1a	1269008200
	AC42V	50/60Hz	1a	1269008300
	AC48V	50/60Hz	1a	1269008400
	AC110V	50/60Hz	1a	1269008500
	AC115V	50/60Hz	1a	1269008600
	AC120V	50/60Hz	1a	1269008700
	AC127V	50/60Hz	1a	1269008800
	AC200V	50/60Hz	1a	1269034500
	AC220V	50/60Hz	1a	1269009000
	AC240V	50/60Hz	1a	1269038200
	AC256V	50/60Hz	1a	1269009300
	AC277V	50/60Hz	1a	1269009400
	AC380V	50/60Hz	1a	1269033300
	AC400V	50/60Hz	1a	1269009600
	AC440V	50/60Hz	1a	1269009700
AC480V	50/60Hz	1a	1269009800	
AC500V	50/60Hz	1a	1269009900	

3-pole AC operating Mini Contactors (6~16A)



Model	Coil Voltage (V)	Hz	No. of Auxiliary Contact	Catalogue No.
GMC-9M	AC550V	50/60Hz	1a	1269010000
	AC24V	50/60Hz	1b	1269010100
	AC36V	50/60Hz	1b	1269010200
	AC42V	50/60Hz	1b	1269010300
	AC48V	50/60Hz	1b	1269010400
	AC110V	50/60Hz	1b	1269010500
	AC115V	50/60Hz	1b	1269010600
	AC120V	50/60Hz	1b	1269010700
	AC127V	50/60Hz	1b	1269010800
	AC200V	50/60Hz	1b	1269038300
	AC220V	50/60Hz	1b	1269011000
	AC240V	50/60Hz	1b	1269038400
	AC256V	50/60Hz	1b	1269011300
	AC277V	50/60Hz	1b	1269011400
	AC380V	50/60Hz	1b	1269033400
	AC400V	50/60Hz	1b	1269011600
	AC440V	50/60Hz	1b	1269011700
	GMC-9MF	AC480V	50/60Hz	1b
AC500V		50/60Hz	1b	1269011900
GMC-12M	AC550V	50/60Hz	1b	1269012000
	AC120V	50/60Hz	1a	1269040100
	AC24V	50/60Hz	1a	1269016700
	AC36V	50/60Hz	1a	1269016800
	AC42V	50/60Hz	1a	1269016900
	AC48V	50/60Hz	1a	1269017000
	AC110V	50/60Hz	1a	1269017100
	AC115V	50/60Hz	1a	1269017200
	AC120V	50/60Hz	1a	1269017300
	AC127V	50/60Hz	1a	1269017400
	AC200V	50/60Hz	1a	1269034600
	AC220V	50/60Hz	1a	1269017600
	AC240V	50/60Hz	1a	1269038900
	AC256V	50/60Hz	1a	1269017900
	AC277V	50/60Hz	1a	1269018000
	AC380V	50/60Hz	1a	1269033700
	AC400V	50/60Hz	1a	1269018200
	AC440V	50/60Hz	1a	1269018300
	AC480V	50/60Hz	1a	1269018400
	AC500V	50/60Hz	1a	1269018500
	AC550V	50/60Hz	1a	1269018600
	AC24V	50/60Hz	1b	1269018800
	AC36V	50/60Hz	1b	1269018900
	AC42V	50/60Hz	1b	1269019000
	AC48V	50/60Hz	1b	1269019100
	AC110V	50/60Hz	1b	1269019200
	AC115V	50/60Hz	1b	1269019300
	AC120V	50/60Hz	1b	1269019400
	AC127V	50/60Hz	1b	1269019500
	AC200V	50/60Hz	1b	1269039000
	AC220V	50/60Hz	1b	1269019700
	AC240V	50/60Hz	1b	1269039100
	AC256V	50/60Hz	1b	1269020000
	AC277V	50/60Hz	1b	1269020100
AC380V	50/60Hz	1b	1269033800	
AC400V	50/60Hz	1b	1269020300	
AC440V	50/60Hz	1b	1269020400	

3-pole AC operating Mini Contactors (6~16A)



Model	Coil Voltage (V)	Hz	No. of Auxiliary Contact	Catalogue No.
GMC-12M	AC480V	50/60Hz	1b	1269020500
	AC500V	50/60Hz	1b	1269020600
	AC550V	50/60Hz	1b	1269020700
GMC-16M	AC24V	50/60Hz	1a	1269026800
	AC36V	50/60Hz	1a	1269026900
	AC42V	50/60Hz	1a	1269027000
	AC48V	50/60Hz	1a	1269027100
	AC110V	50/60Hz	1a	1269027200
	AC115V	50/60Hz	1a	1269027300
	AC120V	50/60Hz	1a	1269027400
	AC127V	50/60Hz	1a	1269027500
	AC200V	50/60Hz	1a	1269034700
	AC220V	50/60Hz	1a	1269027700
	AC230V	50/60Hz	1a	1269047600
	AC240V	50/60Hz	1a	1269039600
	AC256V	50/60Hz	1a	1269028000
	AC277V	50/60Hz	1a	1269028100
	AC380V	50/60Hz	1a	1269034100
	AC400V	50/60Hz	1a	1269028300
	AC440V	50/60Hz	1a	1269028400
	AC480V	50/60Hz	1a	1269028500
	AC500V	50/60Hz	1a	1269028600
	AC550V	50/60Hz	1a	1269028700
	AC24V	50/60Hz	1b	1269028800
	AC36V	50/60Hz	1b	1269028900
	AC42V	50/60Hz	1b	1269029000
	AC48V	50/60Hz	1b	1269029100
	AC110V	50/60Hz	1b	1269029200
	AC115V	50/60Hz	1b	1269029300
	AC120V	50/60Hz	1b	1269029400
	AC127V	50/60Hz	1b	1269029500
	AC200V	50/60Hz	1b	1269039700
	AC220V	50/60Hz	1b	1269029700
	AC240V	50/60Hz	1b	1269039800
	AC256V	50/60Hz	1b	1269030000
	AC277V	50/60Hz	1b	1269030100
AC380V	50/60Hz	1b	1269034200	
AC400V	50/60Hz	1b	1269030300	
AC440V	50/60Hz	1b	1269030400	
AC480V	50/60Hz	1b	1269030500	
AC500V	50/60Hz	1b	1269030600	
AC550V	50/60Hz	1b	1269030700	
GMC-9MP	AC230V	50/60Hz	1a	1269047800
GMC-12MP	AC230V	50/60Hz	1a	1269047500
GMC-16MP	AC120V	50/60Hz	1a	1269043700
	AC120V	50/60Hz	1b	1269045000
GMC-12MF	AC230V	50/60Hz	1a	1269047700
GMC-16MF	AC120V	50/60Hz	1a	1269040200
	AC24V	50/60Hz	1b	1269048400
	AC120V	50/60Hz	1b	1269048500
GMC-16MC	AC120V	50/60Hz	1a	1269040400
	AC230V	50/60Hz	1a	1269047900

3-pole DC operating Mini Contactors (6~16A)



Model	Coil Voltage (V)	Coil consumption	No. of Auxiliary Contact	Catalogue No.
GMD-6M	DC12V	1.2W	1a	1270004300
	DC20V	1.2W	1a	1270004400
	DC24V	1.2W	1a	1270004500
	DC48V	1.2W	1a	1270004600
	DC72V	1.2W	1a	1270004700
	DC110V	1.2W	1a	1270004800
	DC120V	1.2W	1a	1270004900
	DC12V	1.2W	1b	1270007100
	DC20V	1.2W	1b	1270007200
	DC24V	1.2W	1b	1270007300
	DC48V	1.2W	1b	1270007400
	DC72V	1.2W	1b	1270007500
	DC110V	1.2W	1b	1270007600
	DC120V	1.2W	1b	1270007700
	DC12V	2W	1a	1270005000
	DC20V	2W	1a	1270005100
	DC24V	2W	1a	1270005200
	DC48V	2W	1a	1270005300
	DC72V	2W	1a	1270005400
	DC110V	2W	1a	1270005500
	DC120V	2W	1a	1270005600
	DC12V	2W	1b	1270007800
	DC20V	2W	1b	1270007900
	DC24V	2W	1b	1270008000
	DC48V	2W	1b	1270008100
	DC72V	2W	1b	1270008200
	DC110V	2W	1b	1270008300
	DC120V	2W	1b	1270008400
	DC12V	3W	1a	1270002900
	DC20V	3W	1a	1270003000
	DC24V	3W	1a	1270003100
	DC36V	3W	1a	1270003200
	DC42V	3W	1a	1270003300
	DC48V	3W	1a	1270003400
	DC60V	3W	1a	1270003500
	DC72V	3W	1a	1270003600
	DC110V	3W	1a	1270003700
	DC120V	3W	1a	1270003800
	DC125V	3W	1a	1270003900
	DC220V	3W	1a	1270004000
	DC240V	3W	1a	1270004100
	DC250V	3W	1a	1270004200
	DC12V	3W	1b	1270005700
	DC20V	3W	1b	1270005800
	DC24V	3W	1b	1270005900
	DC36V	3W	1b	1270006000
	DC42V	3W	1b	1270006100
	DC48V	3W	1b	1270006200
	DC60V	3W	1b	1270006300
	DC72V	3W	1b	1270006400
DC110V	3W	1b	1270006500	
DC120V	3W	1b	1270006600	
DC125V	3W	1b	1270006700	
DC220V	3W	1b	1270006800	
DC240V	3W	1b	1270006900	
DC250V	3W	1b	1270007000	
DC12V	1.2W	1a	1270015500	

3-pole DC operating Mini Contactors (6~16A)



Model	Coil Voltage (V)	Coil consumption	No. of Auxiliary Contact	Catalogue No.
GMD-9M	DC20V	1.2W	1a	1270015600
	DC24V	1.2W	1a	1270015700
	DC48V	1.2W	1a	1270015800
	DC72V	1.2W	1a	1270015900
	DC110V	1.2W	1a	1270016000
	DC120V	1.2W	1a	1270016100
	DC12V	1.2W	1b	1270018600
	DC20V	1.2W	1b	1270018700
	DC24V	1.2W	1b	1270018800
	DC48V	1.2W	1b	1270018900
	DC72V	1.2W	1b	1270019000
	DC110V	1.2W	1b	1270019100
	DC120V	1.2W	1b	1270019200
	DC12V	2W	1a	1270016200
	DC20V	2W	1a	1270016300
	DC24V	2W	1a	1270016400
	DC48V	2W	1a	1270016500
	DC72V	2W	1a	1270016600
	DC110V	2W	1a	1270016700
	DC120V	2W	1a	1270016800
	DC12V	2W	1b	1270019300
	DC20V	2W	1b	1270019400
	DC24V	2W	1b	1270019500
	DC48V	2W	1b	1270019600
	DC72V	2W	1b	1270019700
	DC110V	2W	1b	1270019800
	DC120V	2W	1b	1270019900
	DC12V	3W	1a	1270014100
	DC20V	3W	1a	1270014200
	DC24V	3W	1a	1270014300
	DC36V	3W	1a	1270014400
	DC42V	3W	1a	1270014500
	DC48V	3W	1a	1270014600
	DC60V	3W	1a	1270014700
	DC72V	3W	1a	1270014800
	DC110V	3W	1a	1270014900
	DC120V	3W	1a	1270015000
	DC125V	3W	1a	1270015100
	DC220V	3W	1a	1270015200
	DC240V	3W	1a	1270015300
DC250V	3W	1a	1270015400	
DC12V	3W	1b	1270017200	
DC20V	3W	1b	1270017300	
DC24V	3W	1b	1270017400	
DC36V	3W	1b	1270017500	
DC42V	3W	1b	1270017600	
DC48V	3W	1b	1270017700	
DC60V	3W	1b	1270017800	
DC72V	3W	1b	1270017900	
DC110V	3W	1b	1270018000	
DC120V	3W	1b	1270018100	
DC125V	3W	1b	1270018200	
DC220V	3W	1b	1270018300	
DC240V	3W	1b	1270018400	
DC250V	3W	1b	1270018500	

3-pole DC operating Mini Contactors (6~16A)



Model	Coil Voltage (V)	Coil consumption	No. of Auxiliary Contact	Catalogue No.
GMD-12M	DC12V	1.2W	1a	1270027000
	DC20V	1.2W	1a	1270027100
	DC24V	1.2W	1a	1270027200
	DC48V	1.2W	1a	1270027300
	DC72V	1.2W	1a	1270027400
	DC110V	1.2W	1a	1270027500
	DC120V	1.2W	1a	1270027600
	DC12V	1.2W	1b	1270029800
	DC20V	1.2W	1b	1270029900
	DC24V	1.2W	1b	1270030000
	DC48V	1.2W	1b	1270030100
	DC72V	1.2W	1b	1270030200
	DC110V	1.2W	1b	1270030300
	DC120V	1.2W	1b	1270030400
	DC12V	2W	1a	1270027700
	DC20V	2W	1a	1270027800
	DC24V	2W	1a	1270027900
	DC48V	2W	1a	1270028000
	DC72V	2W	1a	1270028100
	DC110V	2W	1a	1270028200
	DC120V	2W	1a	1270028300
	DC12V	2W	1b	1270030500
	DC20V	2W	1b	1270030600
	DC24V	2W	1b	1270030700
	DC48V	2W	1b	1270030800
	DC72V	2W	1b	1270030900
	DC110V	2W	1b	1270031000
	DC120V	2W	1b	1270031100
	DC12V	3W	1a	1270025600
	DC20V	3W	1a	1270025700
	DC24V	3W	1a	1270025800
	DC36V	3W	1a	1270025900
	DC42V	3W	1a	1270026000
	DC48V	3W	1a	1270026100
	DC60V	3W	1a	1270026200
	DC72V	3W	1a	1270026300
	DC110V	3W	1a	1270026400
	DC120V	3W	1a	1270026500
	DC125V	3W	1a	1270026600
	DC220V	3W	1a	1270026700
	DC240V	3W	1a	1270026800
	DC250V	3W	1a	1270026900
DC12V	3W	1b	1270028400	
DC20V	3W	1b	1270028500	
DC24V	3W	1b	1270028600	
DC36V	3W	1b	1270028700	
DC42V	3W	1b	1270028800	
DC48V	3W	1b	1270028900	
DC60V	3W	1b	1270029000	
DC72V	3W	1b	1270029100	
DC110V	3W	1b	1270029200	
DC120V	3W	1b	1270029300	
DC125V	3W	1b	1270029400	
DC220V	3W	1b	1270029500	
DC240V	3W	1b	1270029600	
DC250V	3W	1b	1270029700	

3-pole DC operating Mini Contactors (6~16A)



Model	Coil Voltage (V)	Coil consumption	No. of Auxiliary Contact	Catalogue No.
GMD-16M	DC12V	1.2W	1a	1270038300
	DC20V	1.2W	1a	1270038400
	DC24V	1.2W	1a	1270038500
	DC48V	1.2W	1a	1270038600
	DC72V	1.2W	1a	1270038700
	DC110V	1.2W	1a	1270038800
	DC120V	1.2W	1a	1270038900
	DC12V	1.2W	1b	1270041100
	DC20V	1.2W	1b	1270041200
	DC24V	1.2W	1b	1270041300
	DC48V	1.2W	1b	1270041400
	DC72V	1.2W	1b	1270041500
	DC110V	1.2W	1b	1270041600
	DC120V	1.2W	1b	1270041700
	DC12V	2W	1a	1270039000
	DC20V	2W	1a	1270039100
	DC24V	2W	1a	1270039200
	DC48V	2W	1a	1270039300
	DC72V	2W	1a	1270039400
	DC110V	2W	1a	1270039500
	DC120V	2W	1a	1270039600
	DC12V	2W	1b	1270041800
	DC20V	2W	1b	1270041900
	DC24V	2W	1b	1270042000
	DC48V	2W	1b	1270042100
	DC72V	2W	1b	1270042200
	DC110V	2W	1b	1270042300
	DC120V	2W	1b	1270042400
	DC12V	3W	1a	1270036900
	DC20V	3W	1a	1270037000
	DC24V	3W	1a	1270037100
	DC36V	3W	1a	1270037200
	DC42V	3W	1a	1270037300
	DC48V	3W	1a	1270037400
	DC60V	3W	1a	1270037500
	DC72V	3W	1a	1270037600
	DC110V	3W	1a	1270037700
	DC120V	3W	1a	1270037800
	DC125V	3W	1a	1270037900
	DC220V	3W	1a	1270038000
	DC240V	3W	1a	1270038100
	DC250V	3W	1a	1270038200
	DC12V	3W	1b	1270039700
	DC20V	3W	1b	1270039800
	DC24V	3W	1b	1270039900
	DC36V	3W	1b	1270040000
	DC42V	3W	1b	1270040100
DC48V	3W	1b	1270040200	
DC60V	3W	1b	1270040300	
DC72V	3W	1b	1270040400	
DC110V	3W	1b	1270040500	
DC120V	3W	1b	1270040600	
DC125V	3W	1b	1270040700	
DC220V	3W	1b	1270040800	
DC240V	3W	1b	1270040900	
DC250V	3W	1b	1270041000	
GMD-6MF	DC220V	3W	1a	1270047300
GMD-9MP	DC24V	3W	1a	1270046200
GMD-12MP	DC24V	1.2W	1a	1270045900
GMD-9MR	DC60V	3W	2b	1270046000

4-pole AC operating Mini Contactors (6~16A)



Model	Coil Voltage (V)	Hz	Main Contact	Catalogue No.
GMC-6M	AC24V	50/60Hz	2a2b	1269004100
	AC36V	50/60Hz	2a2b	1269004200
	AC42V	50/60Hz	2a2b	1269004300
	AC48V	50/60Hz	2a2b	1269004400
	AC110V	50/60Hz	2a2b	1269004500
	AC115V	50/60Hz	2a2b	1269004600
	AC120V	50/60Hz	2a2b	1269004700
	AC127V	50/60Hz	2a2b	1269004800
	AC200V	50/60Hz	2a2b	1269037800
	AC220V	50/60Hz	2a2b	1269005000
	AC240V	50/60Hz	2a2b	1269037900
	AC256V	50/60Hz	2a2b	1269005300
	AC277V	50/60Hz	2a2b	1269005400
	AC380V	50/60Hz	2a2b	1269033100
	AC400V	50/60Hz	2a2b	1269005600
	AC440V	50/60Hz	2a2b	1269005700
	AC480V	50/60Hz	2a2b	1269005800
	AC500V	50/60Hz	2a2b	1269005900
	AC550V	50/60Hz	2a2b	1269006000
	AC24V	50/60Hz	4a	1269000100
	AC36V	50/60Hz	4a	1269000200
	AC42V	50/60Hz	4a	1269000300
	AC48V	50/60Hz	4a	1269000400
	AC110V	50/60Hz	4a	1269000500
	AC115V	50/60Hz	4a	1269000600
	AC120V	50/60Hz	4a	1269000700
	AC127V	50/60Hz	4a	1269000800
	AC200V	50/60Hz	4a	1269037300
	AC220V	50/60Hz	4a	1269001000
	AC240V	50/60Hz	4a	1269037400
	AC256V	50/60Hz	4a	1269001300
	AC277V	50/60Hz	4a	1269001400
	AC380V	50/60Hz	4a	1269032800
	AC400V	50/60Hz	4a	1269001600
AC440V	50/60Hz	4a	1269001700	
AC480V	50/60Hz	4a	1269001800	
AC500V	50/60Hz	4a	1269001900	
AC550V	50/60Hz	4a	1269002000	
GMC-9M	AC24V	50/60Hz	2a2b	1269012100
	AC36V	50/60Hz	2a2b	1269012200
	AC42V	50/60Hz	2a2b	1269012300
	AC48V	50/60Hz	2a2b	1269012400
	AC110V	50/60Hz	2a2b	1269012500
	AC115V	50/60Hz	2a2b	1269012600
	AC120V	50/60Hz	2a2b	1269012700
	AC127V	50/60Hz	2a2b	1269012800
	AC200V	50/60Hz	2a2b	1269038500
	AC220V	50/60Hz	2a2b	1269013000
	AC240V	50/60Hz	2a2b	1269038600
	AC256V	50/60Hz	2a2b	1269013300
	AC277V	50/60Hz	2a2b	1269013400
	AC380V	50/60Hz	2a2b	1269033500
	AC400V	50/60Hz	2a2b	1269013600
	AC440V	50/60Hz	2a2b	1269013700
	AC480V	50/60Hz	2a2b	1269013800
	AC500V	50/60Hz	2a2b	1269013900

4-pole AC operating Mini Contactors (6~16A)



Model	Coil Voltage (V)	Hz	Main Contact	Catalogue No.
GMC-9M	AC550V	50/60Hz	2a2b	1269014000
	AC24V	50/60Hz	4a	1269006100
	AC36V	50/60Hz	4a	1269006200
	AC42V	50/60Hz	4a	1269006300
	AC48V	50/60Hz	4a	1269006400
	AC110V	50/60Hz	4a	1269006500
	AC115V	50/60Hz	4a	1269006600
	AC120V	50/60Hz	4a	1269006700
	AC127V	50/60Hz	4a	1269006800
	AC200V	50/60Hz	4a	1269038000
	AC220V	50/60Hz	4a	1269007000
	AC240V	50/60Hz	4a	1269038100
	AC256V	50/60Hz	4a	1269007300
	AC277V	50/60Hz	4a	1269007400
	AC380V	50/60Hz	4a	1269033200
	AC400V	50/60Hz	4a	1269007600
	AC440V	50/60Hz	4a	1269007700
AC480V	50/60Hz	4a	1269007800	
AC500V	50/60Hz	4a	1269007900	
GMC-12M	AC550V	50/60Hz	4a	1269008000
	AC24V	50/60Hz	2a2b	1269020800
	AC36V	50/60Hz	2a2b	1269020900
	AC42V	50/60Hz	2a2b	1269021000
	AC48V	50/60Hz	2a2b	1269021100
	AC110V	50/60Hz	2a2b	1269021200
	AC115V	50/60Hz	2a2b	1269021300
	AC120V	50/60Hz	2a2b	1269021400
	AC127V	50/60Hz	2a2b	1269021500
	AC200V	50/60Hz	2a2b	1269039200
	AC220V	50/60Hz	2a2b	1269021700
	AC240V	50/60Hz	2a2b	1269039300
	AC256V	50/60Hz	2a2b	1269022000
	AC277V	50/60Hz	2a2b	1269022100
	AC380V	50/60Hz	2a2b	1269033900
	AC400V	50/60Hz	2a2b	1269022300
	AC440V	50/60Hz	2a2b	1269022400
	AC480V	50/60Hz	2a2b	1269022500
	AC500V	50/60Hz	2a2b	1269022600
	AC550V	50/60Hz	2a2b	1269022700
	AC24V	50/60Hz	4a	1269014100
	AC36V	50/60Hz	4a	1269014200
	AC42V	50/60Hz	4a	1269014300
	AC48V	50/60Hz	4a	1269014400
	AC110V	50/60Hz	4a	1269014500
	AC115V	50/60Hz	4a	1269014600
	AC120V	50/60Hz	4a	1269014700
	AC127V	50/60Hz	4a	1269014800
	AC200V	50/60Hz	4a	1269038700
	AC220V	50/60Hz	4a	1269015000
	AC240V	50/60Hz	4a	1269038800
	AC256V	50/60Hz	4a	1269015300
	AC277V	50/60Hz	4a	1269015400
	AC380V	50/60Hz	4a	1269033600
AC400V	50/60Hz	4a	1269016200	
AC440V	50/60Hz	4a	1269016300	
AC480V	50/60Hz	4a	1269016400	
AC500V	50/60Hz	4a	1269016500	

4-pole AC operating Mini Contactors (6~16A)



Model	Coil Voltage (V)	Hz	Main Contact	Catalogue No.
GMC-16M	AC24V	50/60Hz	2a2b	1269030800
	AC36V	50/60Hz	2a2b	1269030900
	AC42V	50/60Hz	2a2b	1269031000
	AC48V	50/60Hz	2a2b	1269031100
	AC110V	50/60Hz	2a2b	1269031200
	AC115V	50/60Hz	2a2b	1269031300
	AC120V	50/60Hz	2a2b	1269031400
	AC127V	50/60Hz	2a2b	1269031500
	AC200V	50/60Hz	2a2b	1269039900
	AC220V	50/60Hz	2a2b	1269031700
	AC240V	50/60Hz	2a2b	1269040000
	AC256V	50/60Hz	2a2b	1269032000
	AC277V	50/60Hz	2a2b	1269032100
	AC380V	50/60Hz	2a2b	1269034300
	AC400V	50/60Hz	2a2b	1269032300
	AC440V	50/60Hz	2a2b	1269032400
	AC480V	50/60Hz	2a2b	1269032500
	AC500V	50/60Hz	2a2b	1269032600
	AC550V	50/60Hz	2a2b	1269032700
	AC24V	50/60Hz	4a	1269024800
	AC36V	50/60Hz	4a	1269024900
	AC42V	50/60Hz	4a	1269025000
	AC48V	50/60Hz	4a	1269025100
	AC110V	50/60Hz	4a	1269025200
	AC115V	50/60Hz	4a	1269025300
	AC120V	50/60Hz	4a	1269025400
	AC127V	50/60Hz	4a	1269025500
	AC200V	50/60Hz	4a	1269039400
	AC220V	50/60Hz	4a	1269025700
	AC240V	50/60Hz	4a	1269039500
	AC256V	50/60Hz	4a	1269026000
	AC277V	50/60Hz	4a	1269026100
	AC380V	50/60Hz	4a	1269034000
	AC400V	50/60Hz	4a	1269026300
AC440V	50/60Hz	4a	1269026400	
AC480V	50/60Hz	4a	1269026500	
AC500V	50/60Hz	4a	1269026600	
AC550V	50/60Hz	4a	1269026700	

4-pole DC operating Mini Contactors (6~16A)



Model	Coil Voltage (V)	Coil consumption	Main contact	Catalogue No.
GMD-6M	DC12V	1.2W	2a2b	1270009900
	DC20V	1.2W	2a2b	1270010000
	DC24V	1.2W	2a2b	1270010100
	DC48V	1.2W	2a2b	1270010200
	DC72V	1.2W	2a2b	1270010300
	DC110V	1.2W	2a2b	1270010400
	DC120V	1.2W	2a2b	1270010500
	DC12V	1.2W	4a	1270001500
	DC20V	1.2W	4a	1270001600
	DC24V	1.2W	4a	1270001700
	DC48V	1.2W	4a	1270001800
	DC72V	1.2W	4a	1270001900
	DC110V	1.2W	4a	1270002000
	DC120V	1.2W	4a	1270002100
	DC12V	2W	2a2b	1270010600
	DC20V	2W	2a2b	1270010700
	DC24V	2W	2a2b	1270010800
	DC48V	2W	2a2b	1270010900
	DC72V	2W	2a2b	1270011000
	DC110V	2W	2a2b	1270011100
	DC120V	2W	2a2b	1270011200
	DC12V	2W	4a	1270002200
	DC20V	2W	4a	1270002300
	DC24V	2W	4a	1270002400
	DC48V	2W	4a	1270002500
	DC72V	2W	4a	1270002600
	DC110V	2W	4a	1270002700
	DC120V	2W	4a	1270002800
	DC12V	3W	4a	1270000100
	DC20V	3W	4a	1270000200
	DC24V	3W	4a	1270000300
	DC36V	3W	4a	1270000400
	DC42V	3W	4a	1270000500
	DC48V	3W	4a	1270000600
	DC60V	3W	4a	1270000700
	DC72V	3W	4a	1270000800
	DC110V	3W	4a	1270000900
	DC120V	3W	4a	1270001000
	DC125V	3W	4a	1270001100
	DC220V	3W	4a	1270001200
	DC240V	3W	4a	1270001300
	DC250V	3W	4a	1270001400
DC12V	3W	2a2b	1270008500	
DC20V	3W	2a2b	1270008600	
DC24V	3W	2a2b	1270008700	
DC36V	3W	2a2b	1270008800	
DC42V	3W	2a2b	1270008900	
DC48V	3W	2a2b	1270009000	
DC60V	3W	2a2b	1270009100	
DC72V	3W	2a2b	1270009200	
DC110V	3W	2a2b	1270009300	
DC120V	3W	2a2b	1270009400	
DC125V	3W	2a2b	1270009500	
DC220V	3W	2a2b	1270009600	
DC240V	3W	2a2b	1270009700	
DC250V	3W	2a2b	1270009800	

4-pole DC operating Mini Contactors (6~16A)



Model	Coil Voltage (V)	Coil consumption	Main contact	Catalogue No.
GMD-9M	DC12V	1.2W	2a2b	1270021400
	DC20V	1.2W	2a2b	1270021500
	DC24V	1.2W	2a2b	1270021600
	DC48V	1.2W	2a2b	1270021700
	DC72V	1.2W	2a2b	1270021800
	DC110V	1.2W	2a2b	1270021900
	DC120V	1.2W	2a2b	1270022000
	DC12V	1.2W	4a	1270012700
	DC20V	1.2W	4a	1270012800
	DC24V	1.2W	4a	1270012900
	DC48V	1.2W	4a	1270013000
	DC72V	1.2W	4a	1270013100
	DC110V	1.2W	4a	1270013200
	DC120V	1.2W	4a	1270013300
	DC12V	2W	2a2b	1270022100
	DC20V	2W	2a2b	1270022200
	DC24V	2W	2a2b	1270022300
	DC48V	2W	2a2b	1270022400
	DC72V	2W	2a2b	1270022500
	DC110V	2W	2a2b	1270022600
	DC120V	2W	2a2b	1270022700
	DC12V	2W	4a	1270013400
	DC20V	2W	4a	1270013500
	DC24V	2W	4a	1270013600
	DC48V	2W	4a	1270013700
	DC72V	2W	4a	1270013800
	DC110V	2W	4a	1270013900
	DC120V	2W	4a	1270014000
	DC12V	3W	4a	1270011300
	DC20V	3W	4a	1270011400
	DC24V	3W	4a	1270011500
	DC36V	3W	4a	1270011600
	DC42V	3W	4a	1270011700
	DC48V	3W	4a	1270011800
	DC60V	3W	4a	1270011900
	DC72V	3W	4a	1270012000
	DC110V	3W	4a	1270012100
	DC120V	3W	4a	1270012200
	DC125V	3W	4a	1270012300
	DC220V	3W	4a	1270012400
	DC240V	3W	4a	1270012500
	DC250V	3W	4a	1270012600
DC12V	3W	2a2b	1270020000	
DC20V	3W	2a2b	1270020100	
DC24V	3W	2a2b	1270020200	
DC36V	3W	2a2b	1270020300	
DC42V	3W	2a2b	1270020400	
DC48V	3W	2a2b	1270020500	
DC60V	3W	2a2b	1270020600	
DC72V	3W	2a2b	1270020700	
DC110V	3W	2a2b	1270020800	
DC120V	3W	2a2b	1270020900	
DC125V	3W	2a2b	1270021000	
DC220V	3W	2a2b	1270021100	
DC240V	3W	2a2b	1270021200	
DC250V	3W	2a2b	1270021300	

4-pole DC operating Mini Contactors (6~16A)



Model	Coil Voltage (V)	Coil consumption	Main contact	Catalogue No.
GMD-12M	DC12V	1.2W	2a2b	1270032600
	DC20V	1.2W	2a2b	1270032700
	DC24V	1.2W	2a2b	1270032800
	DC48V	1.2W	2a2b	1270032900
	DC72V	1.2W	2a2b	1270033000
	DC110V	1.2W	2a2b	1270033100
	DC120V	1.2W	2a2b	1270033200
	DC12V	1.2W	4a	1270024200
	DC20V	1.2W	4a	1270024300
	DC24V	1.2W	4a	1270024400
	DC48V	1.2W	4a	1270024500
	DC72V	1.2W	4a	1270024600
	DC110V	1.2W	4a	1270024700
	DC120V	1.2W	4a	1270024800
	DC12V	2W	2a2b	1270033300
	DC20V	2W	2a2b	1270033400
	DC24V	2W	2a2b	1270033500
	DC48V	2W	2a2b	1270033600
	DC72V	2W	2a2b	1270033700
	DC110V	2W	2a2b	1270033800
	DC120V	2W	2a2b	1270033900
	DC12V	2W	4a	1270024900
	DC20V	2W	4a	1270025000
	DC24V	2W	4a	1270025100
	DC48V	2W	4a	1270025200
	DC72V	2W	4a	1270025300
	DC110V	2W	4a	1270025400
	DC120V	2W	4a	1270025500
	DC12V	3W	2a2b	1270031200
	DC20V	3W	2a2b	1270031300
	DC24V	3W	2a2b	1270031400
	DC36V	3W	2a2b	1270031500
	DC42V	3W	2a2b	1270031600
	DC48V	3W	2a2b	1270031700
	DC60V	3W	2a2b	1270031800
	DC72V	3W	2a2b	1270031900
	DC110V	3W	2a2b	1270032000
	DC120V	3W	2a2b	1270032100
	DC125V	3W	2a2b	1270032200
	DC220V	3W	2a2b	1270032300
	DC240V	3W	2a2b	1270032400
	DC250V	3W	2a2b	1270032500
	DC12V	3W	4a	1270022800
	DC20V	3W	4a	1270022900
	DC24V	3W	4a	1270023000
DC36V	3W	4a	1270023100	
DC42V	3W	4a	1270023200	
DC48V	3W	4a	1270023300	
DC60V	3W	4a	1270023400	
DC72V	3W	4a	1270023500	
DC110V	3W	4a	1270023600	
DC120V	3W	4a	1270023700	
DC125V	3W	4a	1270023800	
DC220V	3W	4a	1270023900	
DC240V	3W	4a	1270024000	
DC250V	3W	4a	1270024100	

4-pole DC operating Mini Contactors (6~16A)



Model	Coil Voltage (V)	Coil consumption	Main contact	Catalogue No.
GMD-16M	DC12V	1.2W	2a2b	1270043900
	DC20V	1.2W	2a2b	1270044000
	DC24V	1.2W	2a2b	1270044100
	DC48V	1.2W	2a2b	1270044200
	DC72V	1.2W	2a2b	1270044300
	DC110V	1.2W	2a2b	1270044400
	DC120V	1.2W	2a2b	1270044500
	DC12V	1.2W	4a	1270035500
	DC20V	1.2W	4a	1270035600
	DC24V	1.2W	4a	1270035700
	DC48V	1.2W	4a	1270035800
	DC72V	1.2W	4a	1270035900
	DC110V	1.2W	4a	1270036000
	DC120V	1.2W	4a	1270036100
	DC12V	2W	2a2b	1270044600
	DC20V	2W	2a2b	1270044700
	DC24V	2W	2a2b	1270044800
	DC48V	2W	2a2b	1270044900
	DC72V	2W	2a2b	1270045000
	DC110V	2W	2a2b	1270045100
	DC120V	2W	2a2b	1270045200
	DC12V	2W	4a	1270036200
	DC20V	2W	4a	1270036300
	DC24V	2W	4a	1270036400
	DC48V	2W	4a	1270036500
	DC72V	2W	4a	1270036600
	DC110V	2W	4a	1270036700
	DC120V	2W	4a	1270036800
	DC12V	3W	2a2b	1270042500
	DC20V	3W	2a2b	1270042600
	DC24V	3W	2a2b	1270042700
	DC36V	3W	2a2b	1270042800
	DC42V	3W	2a2b	1270042900
	DC48V	3W	2a2b	1270043000
	DC60V	3W	2a2b	1270043100
	DC72V	3W	2a2b	1270043200
	DC110V	3W	2a2b	1270043300
	DC120V	3W	2a2b	1270043400
	DC125V	3W	2a2b	1270043500
	DC220V	3W	2a2b	1270043600
	DC240V	3W	2a2b	1270043700
	DC250V	3W	2a2b	1270043800
DC12V	3W	4a	1270034100	
DC20V	3W	4a	1270034200	
DC36V	3W	4a	1270034400	
DC42V	3W	4a	1270034500	
DC48V	3W	4a	1270034600	
DC60V	3W	4a	1270034700	
DC72V	3W	4a	1270034800	
DC110V	3W	4a	1270034900	
DC120V	3W	4a	1270035000	
DC125V	3W	4a	1270035100	
DC220V	3W	4a	1270035200	
DC240V	3W	4a	1270035300	
DC250V	3W	4a	1270035400	

3-pole AC Contactors, Definite purpose



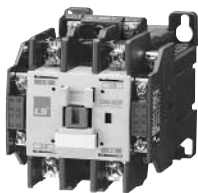

Type	Model	Rated voltage	Frequency	Code
GMC-P2	GMC-10P2	AC220V	50/60Hz	1230006100
	GMC-20P2	AC220V	50/60Hz	1230005500
	GMC-25P2	AC220V	50/60Hz	1230005600
	GMC-30P2	AC220V	50/60Hz	1230005700
	GMC-35P2	AC220V	50/60Hz	1230005800
	GMC-40P2	AC220V	50/60Hz	1230005900
	GMC-10P2	AC24V	50/60Hz	1230006200
		AC48V	50/60Hz	1230006300
		AC100V	50/60Hz	1230006400
		AC110V	50/60Hz	1230006500
		AC120V	50/60Hz	1230006600
		AC200V	50/60Hz	1230006700
		AC230V	50/60Hz	1230006800
	GMC-20P2	AC240V	50/60Hz	1230006900
		AC24V	50/60Hz	1230007000
		AC48V	50/60Hz	1230007100
		AC100V	50/60Hz	1230007200
		AC110V	50/60Hz	1230007300
		AC120V	50/60Hz	1230007400
		AC200V	50/60Hz	1230007500
	GMC-25P2	AC230V	50/60Hz	1230007600
		AC240V	50/60Hz	1230007700
		AC24V	50/60Hz	1230007800
		AC48V	50/60Hz	1230007900
		AC100V	50/60Hz	1230008000
		AC110V	50/60Hz	1230008100
		AC120V	50/60Hz	1230008200
	GMC-30P2	AC200V	50/60Hz	1230008300
		AC230V	50/60Hz	1230008400
		AC240V	50/60Hz	1230008500
		AC24V	50/60Hz	1230008600
		AC48V	50/60Hz	1230008700
		AC100V	50/60Hz	1230008800
		AC110V	50/60Hz	1230008900
	GMC-35P2	AC120V	50/60Hz	1230009000
		AC200V	50/60Hz	1230009100
		AC230V	50/60Hz	1230009200
		AC240V	50/60Hz	1230009300
		AC24V	50/60Hz	1230009400
		AC48V	50/60Hz	1230009500
AC100V		50/60Hz	1230009600	
GMC-40P2	AC110V	50/60Hz	1230009700	
	AC120V	50/60Hz	1230009800	
	AC200V	50/60Hz	1230009900	
	AC230V	50/60Hz	1230010000	
	AC240V	50/60Hz	1230010100	
	AC24V	50/60Hz	1230010200	
	AC48V	50/60Hz	1230010300	
GMC-40P2	AC100V	50/60Hz	1230010400	
	AC110V	50/60Hz	1230010500	
	AC120V	50/60Hz	1230010600	
	AC200V	50/60Hz	1230010700	
	AC230V	50/60Hz	1230010800	
	AC240V	50/60Hz	1230010900	

2-pole DC Contactors



Type	Rated Voltage	Hz	No. of Contact	Terminal code	Code
SMM-30P	AC120V		2a2b		1232000700
SMM-60P	AC100V		2a2b		1232002500
	AC120V		2a2b		1232002700
SMM-100P	AC100V		2a2b		1232004500
	AC120V		2a2b		1232004700
SMM-30DP	DC24V		2a2b		1232006100
	DC48V		2a2b		1232006300
	DC110V		2a2b		1232006700
	DC220V		2a2b		1232007300
SMM-60DP	DC24V		2a2b		1232007500
	DC48V		2a2b		1232007700
	DC110V		2a2b		1232008100
	DC220V		2a2b		1232008700
SMM-100DP	DC24V		2a2b		1232008900
	DC48V		2a2b		1232009100

Manual Motor Starters

Model	Setting range of thermal trips (A)	IEC Breaking capacity at 415V (kA)	Handle type	Code
32AF 	0.1~0.16	100	Toggle	0705003300
	0.16~0.25	100		0705003400
	0.25~0.4	100		0705003500
	0.4~0.63	100		0705003600
	0.63~1	100		0705003700
	1~1.6	100		0705003800
	1.6~2.5	100		0705003900
	2.5~4	100		0705004000
	4~6	100		0705004100
	5~8	100		0705004200
	6~10	50		0705004300
	9~13	50		0705004400
	11~17	20		0705004500
	14~22	15		0705004600
	18~26	15		0705004700
22~32	15	0705004800		
	0.1~0.16	100	Rotary	0705000100
	0.16~0.25	100		0705000200
	0.25~0.4	100		0705000300
	0.4~0.63	100		0705000400
	0.63~1	100		0705000500
	1~1.6	100		0705000600
	1.6~2.5	100		0705000700
	2.5~4	100		0705000800
	4~6	100		0705000900
	5~8	100		0705001000
	6~10	100		0705001100
	9~13	100		0705001200
	11~17	50		0705001300
	14~22	50		0705001400
	18~26	50		0705001500
22~32	50	0705001600		
	0.16	100	Rotary	0705001700
	0.25	100		0705001800
	4	100		0705001900
	0.63	100		0705002000
	1	100		0705002100
	1.6	100		0705002200
	2.5	100		0705002300
	4	100		0705002400
	6	100		0705002500
	8	100		0705002600
	10	100		0705002700
	13	100		0705002800
	17	50		0705002900
	22	50		0705003000
	26	50		0705003100
32	50	0705003200		

Manual Motor Starters

63AF









100AF





Model	Setting range of thermal trips (A)	IEC Breaking capacity at 415V (kA)	Handle type	Code
MMS-63S	6~10	100	Rotary	0706000100
	9~13	50		0706000200
	11~17	25		0706000300
	14~22	25		0706000400
	18~26	25		0706000500
	22~32	25		0706000600
	28~40	25		0706000700
	34~50	25		0706000800
MMS-63H	45~63	25	Rotary	0706000900
	6~10	100		0706001000
	9~13	100		0706001100
	11~17	50		0706001200
	14~22	50		0706001300
	18~26	50		0706001400
	22~32	50		0706001500
	28~40	50		0706001600
MMS-63HI	34~50	50	Rotary	0706001700
	45~63	50		0706001800
	10	100		0706001900
	13	100		0706002000
	17	50		0706002100
	22	50		0706002200
	26	50		0706002300
	32	50		0706002400
MMS-100S	40	50	Rotary	0706002500
	50	50		0706002600
	63	50		0706002700
	11~17	50		0707000100
	14~22	50		0707000200
	18~26	50		0707000300
	22~32	50		0707000400
	28~40	50		0707000500
MMS-100H	34~50	50	Rotary	0707000600
	45~63	50		0707000700
	55~75	50		0707000800
	70~90	50		0707000900
	80~100	50		0707001000
	11~17	100		0707001100
	14~22	100		0707001200
	18~26	100		0707001300
MMS-100HI	22~32	100	Rotary	0707001400
	28~40	100		0707001500
	34~50	100		0707001600
	45~63	100		0707001700
	55~75	75		0707001800
	70~90	75		0707001900
	80~100	75		0707002000
	17	100		0707002100
MMS-100HI	22	100	Rotary	0707002200
	26	100		0707002300
	32	100		0707002400
	40	100		0707002500
	50	100		0707002600
	63	100		0707002700
	75	75		0707002800
	90	75		0707002900
100	75	0707003000		

Accessories (For MMS)

Type	Model	Description	Applied product	Code
Auxiliary switch 	FX	2NO	MMS-32~100	83361941001
		1NO 1NC		83361941002
		2NC		83361941003
	LX	2NO		83361941004
		1NO 1NC		83361941005
		2NC		83361941006
Any trip alarm switch 	LA	2NO (Operates in case of trip)		83011941001
		1NO 1NC (Operates in case of trip)		83011941002
		2NC (Operates in case of trip)		83011941003
Magnetic trip alarm switch 	LAM	2NO (Operates in case of instantaneous trip)		83011941004
		1NO 1NC (Operates in case of instantaneous trip)		83011941005
		2NC (Operates in case of instantaneous trip)		83011941006
Shunt release 	RS	AC24V 50Hz/28V 60Hz	70911941001	
		AC110V 50Hz/120V 60Hz	70911941002	
		AC220~230V 50Hz/240~260V 60Hz	70911941003	
		AC240V 50Hz/277V 60Hz	70911941004	
		AC380~400V 50Hz/440~460V 60Hz	70911941005	
		AC415~440V 50Hz/460~480V 60Hz	70911941006	
		AC200V 50Hz/AC200V~220V 60Hz	70911941020	
Undervoltage release 	RU	AC24V 50Hz/28V 60Hz	83211941001	
		AC110V 50Hz/120V 60Hz	83211941002	
		AC220~230V 50Hz/240~260V 60Hz	83211941003	
		AC240V 50Hz/277V 60Hz	83211941004	
		AC380~400V 50Hz/440~460V 60Hz	83211941005	
		AC415~440V 50Hz/460~480V 60Hz	83211941006	
		AC200V 50Hz/AC200V~220V 60Hz	83211941007	
Undervoltage release with switch 	RUX	AC24V 50Hz/28V 60Hz	83211941021	
		AC110V 50Hz/120V 60Hz	83211941022	
		AC220~230V 50Hz/240~260V 60Hz	83211941023	
		AC240V 50Hz/277V 60Hz	83211941024	
		AC380~400V 50Hz/440~460V 60Hz	83211941025	
		AC415~440V 50Hz/460~480V 60Hz	83211941026	
		AC200V 50Hz/AC200V~220V 60Hz	83211941027	

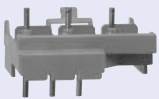
Accessories (For MMS)

Type	Model	Description	Applied product	Code
Direct Adapter 	DA-16SA	AC type mini contactor	GMC-6M~16M	73311941001
	DA-16SD	DC type mini contactor	GMD-6M~16M	73311941002
	DA-16HA	AC type mini contactor	GMC-6M~16M	73311941003
	DA-16HD	DC type mini contactor	GMD-6M~16M	73311941004
	DA-32SA	AC type 32AF(Toggle)	MC-9~32	73311634001
	DA-32HA	AC type 32AF(Rotary)	MC-9~32	73311634002
	DA-32SD	DC type 32AF(Toggle)	MC-9~32	73311634003
	DA-32HD	DC type 32AF(Rotary)	MC-9~32	73311634004
	DA-63A	AC type 63AF	MC-35~63	73311634005
	DA-63D	DC type 63AF	MC-35~63	73311634006
	DA-95A	AC type 95AF	MC-65~95	73311634007
	DA-95D	DC type 95AF	MC-65~95	73311634008

Type	Model	Description	Applied product	Code
Mounting unit 	MU-45	45mm width	MMS-32	83661941001
	MU-55	55mm width	MMS-63	83661941011
	MU-70	70mm width	MMS-100	83661941021

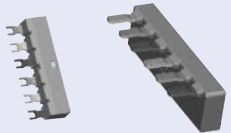
Type	Model	Description	Applied product	Code
Phase bus 	PB-322	Use two of 32AF MMS	MMS-32	70211941201
	PB-632	Use two of 63AF MMS	MMS-63	70211941202

Type	Model	Description	Applied product	Code
Dial cover UL barrier 	Dial Cover	To protect the setting current	MMS-32~100	64621911009
	IB100	Insulation barrier	MMS-100	67221931001

Leading Innovation, Creating Tomorrow 



Safety Instructions

- For your safety, please read user's manual thoroughly before operating.
- Contact the nearest authorized service facility for examination, repair, or adjustment.
- Please contact a qualified service technician when you need maintenance. Do not disassemble or repair by yourself!
- Any maintenance and inspection shall be performed by the personnel having expertise concerned.

LS Industrial Systems Co., Ltd. © 2008.10 LS Industrial Systems Co.,Ltd. All rights reserved.

www.lsis.biz

■ HEAD OFFICE

LS Tower 1026-6, Hogue-dong, Dongan-gu,
Anyang-si, Gyeonggi-do 431-848, Korea

Tel. (82-2)2034-4887, 4873, 4148

Fax. (82-2)2034-4648

■ CHEONG-JU PLANT

Cheong-Ju Plant #1, Song Jung Dong, Hung Duk Ku,
Cheong Ju, 361-720, Korea

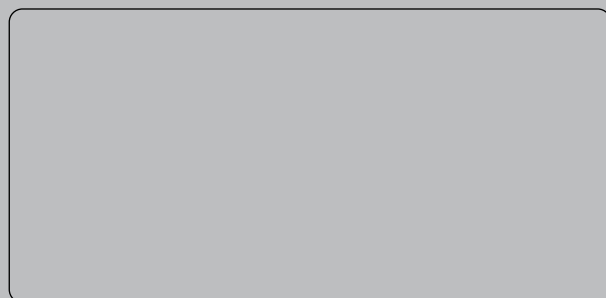

Specifications in this catalog are subject to change without notice due to continuous product development and improvement.

■ Global Network

- **LS Industrial Systems (Middle East) FZE >> Dubai, U.A.E.**
Address: LOB 19 JAFZA VIEW TOWER Room 205, Jebel Ali Freezone P.O. Box 114216, Dubai, United Arab Emirates
Tel: 971-4-886 5360 Fax: 971-4-886-5361 e-mail: hwyim@lsis.biz
- **Dalian LS Industrial Systems Co., Ltd. >> Dalian, China**
Address: No.15, Liaohexi 3-Road, Economic and Technical Development zone, Dalian 116600, China
Tel: 86-411-8273-7777 Fax: 86-411-8730-7560 e-mail: lixk@lsis.com.cn
- **LS Industrial Systems (Wuxi) Co., Ltd. >> Wuxi, China**
Address: 102-A, National High & New Tech Industrial Development Area, Wuxi, Jiangsu, 214028, P.R.China
Tel: 86-510-8534-6666 Fax: 86-510-522-4078 e-mail: xuhg@lsis.com.cn
- **LS-VINA Industrial Systems Co., Ltd. >> Hanoi, Vietnam**
Address: Nguyen Khe - Dong Anh - Ha Noi - Viet Nam
Tel: 84-4-882-0222 Fax: 84-4-882-0220 e-mail: srjo@lsisvina.com
- **LS-VINA Industrial Systems Co., Ltd. >> Hochiminh, Vietnam**
Address: 41 Nguyen Thi Minh Khai Str. Yoco Bldg 4th Floor, Hochiminh City, Vietnam
Tel: 84-8-3822-7941 Fax: 84-8-3822-7942 e-mail: sbpark@lsisvina.com
- **LS Industrial Systems Tokyo Office >> Tokyo, Japan**
Address: 16FL, Higashi-Kan, Akasaka Twin Tower 17-22, 2-chome, Akasaka, Minato-ku Tokyo 107-8470, Japan
Tel: 81-3-3582-9128 Fax: 81-3-3582-2667 e-mail: jschuna@lsis.biz
- **LS Industrial Systems Shanghai Office >> Shanghai, China**
Address: Room E-G, 12th Floor Huamin Empire Plaza, No.726, West Yan'an Road Shanghai 200050, P.R. China
Tel: 86-21-5237-9977 (609) Fax: 89-21-5237-7191 e-mail: jinhk@lsis.com.cn
- **LS Industrial Systems Beijing Office >> Beijing, China**
Address: B-Tower 17FL, Beijing Global Trade Center B/D. No.36, BeiSanHuanDong-Lu, DongCheng-District, Beijing 100013, P.R. China
Tel: 86-10-5825-6025,7 Fax: 86-10-5825-6026 e-mail: cuixiaorong@lsis.com.cn
- **LS Industrial Systems Guangzhou Office >> Guangzhou, China**
Address: Room 1403,14F,New Poly Tower,2 Zhongshan Liu Road,Guangzhou, P.R. China
Tel: 86-20-8326-6764 Fax: 86-20-8326-6287 e-mail: linsz@lsis.biz
- **LS Industrial Systems Chengdu Office >> Chengdu, China**
Address: Room 1701 17Floor, huanminhanjun international Building, No1 Fuxing Road Chengdu, 610041, P.R. China
Tel: 86-28-8670-3101 Fax: 86-28-8670-3203 e-mail: yangcf@lsis.com.cn
- **LS Industrial Systems Qingdao Office >> Qingdao, China**
Address: 7B40,Haixin Guangchang Shenye Building B, No.9, Shandong Road Qingdao 26600, P.R. China
Tel: 86-532-8501-6568 Fax: 86-532-583-3793 e-mail: lirj@lsis.com.cn