

Panasonic

OVERVIEW

AC SERVO DRIVES &
MOTION CONTROL





D GT and HM500 series touch terminals

Page 51

A MINAS A5 series servo drives

Page 6

B Motion control libraries, configuration and programming software

Page 44

C FP series PLCs

Page 38

A MINAS A5 series servo drives

Highly dynamic servo drives with state-of-the-art technology. Large power range (50W–15kW) combined with a light-weight and compact design. Innovative functions to suppress resonance frequencies and vibrations. Multiple control features such as pulse, analog, and network technology in real-time communication (100Mbit/s).

B Motion control libraries, configuration and programming software

PLC programming software Control FPCWIN Pro (compliant with IEC 61131-3). The free configuration software PANATERM and M-SELECT support users in the system setup, thus shortening the time required for commissioning. In addition, you can download motion control libraries for free. With the libraries' predefined function blocks, it is easy to solve even complex positioning tasks.

C FP series PLC

The PLC comes already equipped with the hardware required for positioning tasks. FP0R, FPΣ (Sigma), and FP-X are capable of controlling up to 4 axes independently. By using positioning units, the system can be expanded to control up to 10 axes. The FP7 can even control up to 64 axes. Add network technology in the shape of RTEX or EtherCAT positioning units, and the FP series allows you to control up to 256 axes with the real-time Ethernet bus.

D GT and HM500 series touch terminals

Touch terminals allow humans and machines to interact with each other. The machine's role therein is to display data, results, messages, etc. and to receive instructions and execute tasks assigned by people. Panasonic's new touch terminals are ideally suited for these tasks. They are optimally suited both for factory and building automation. Panasonic HMIs cover a wide spectrum, ranging in size from a compact 3" touch panel to a color 13" display for sophisticated applications.

Contents

Comprehensive MC solutions by Panasonic ..2	Accessories36-37
Overview.....3	Programmable controllers.....38
Applications4	Positioning functions.....39-43
MINAS A5 series6-28	Software44-49
MINAS LIQI series.....29-32	Memo.....50
Cables.....33-35	Other Panasonic products51



MINAS series		LIQI	A5E	A5	A5N	A5B
Rated power		50–1000W	50–5000W	50–15000W		
Supply voltage	up to 1500W	1-phase 200V AC	1-/3-phase 200V AC			
	from 1000W	–	3-phase 400V AC			
Bandwidth (velocity response)		1000Hz	2000Hz			
Rated rotational speed		1500–3000 (rpm)				
Max. rotational speed		2000–6000 (rpm)				
Rated torque		0.16–3.2Nm	0.16–23.9Nm	0.16–99.5Nm		
Peak torque		0.48–9.5Nm	0.48–71.6Nm	0.48–224Nm		
Control functions		Position control		Position, velocity, and torque control		
IP degree of protection (motor)		IP65	IP67			
Control input		Pulse		Pulse, analog	Network	

Applications

With its power range of 50 to 15,000W, Panasonic servo drives are ideally suited to solve both small (1 or 2 axes) and complex tasks (up to 256 axes) easily and quickly.

The following industries make use of servo drives: packaging, textile, plastics, wood, paper, metal and mounting, and processing.

Application examples:

Packaging machine

A complete solution with PLC, touch terminal, and servo drives from Panasonic. Our compact drives offer a great advantage over competitor's products for packaging machines (labeling, packing, etc.).



X-Y table

Positioning XY axes to apply adhesive.

One FPΣ (Sigma) controls 2 servo drives as well as the adhesive-dispensing device according to the predefined profile.



Cutting machine

The FP2SH PLC controls the positioning so that the machine can cut at high speed and with an accuracy of 10 micrometers.



Food processing machine

This solution from Panasonic includes an FP0R PLC, a GT32 touch terminal, a MINAS A5 driver, and a VF0 inverter. To make burgers, the movement of three axes has to be precisely synchronized.



Connector type (100/200V: A to E frame)

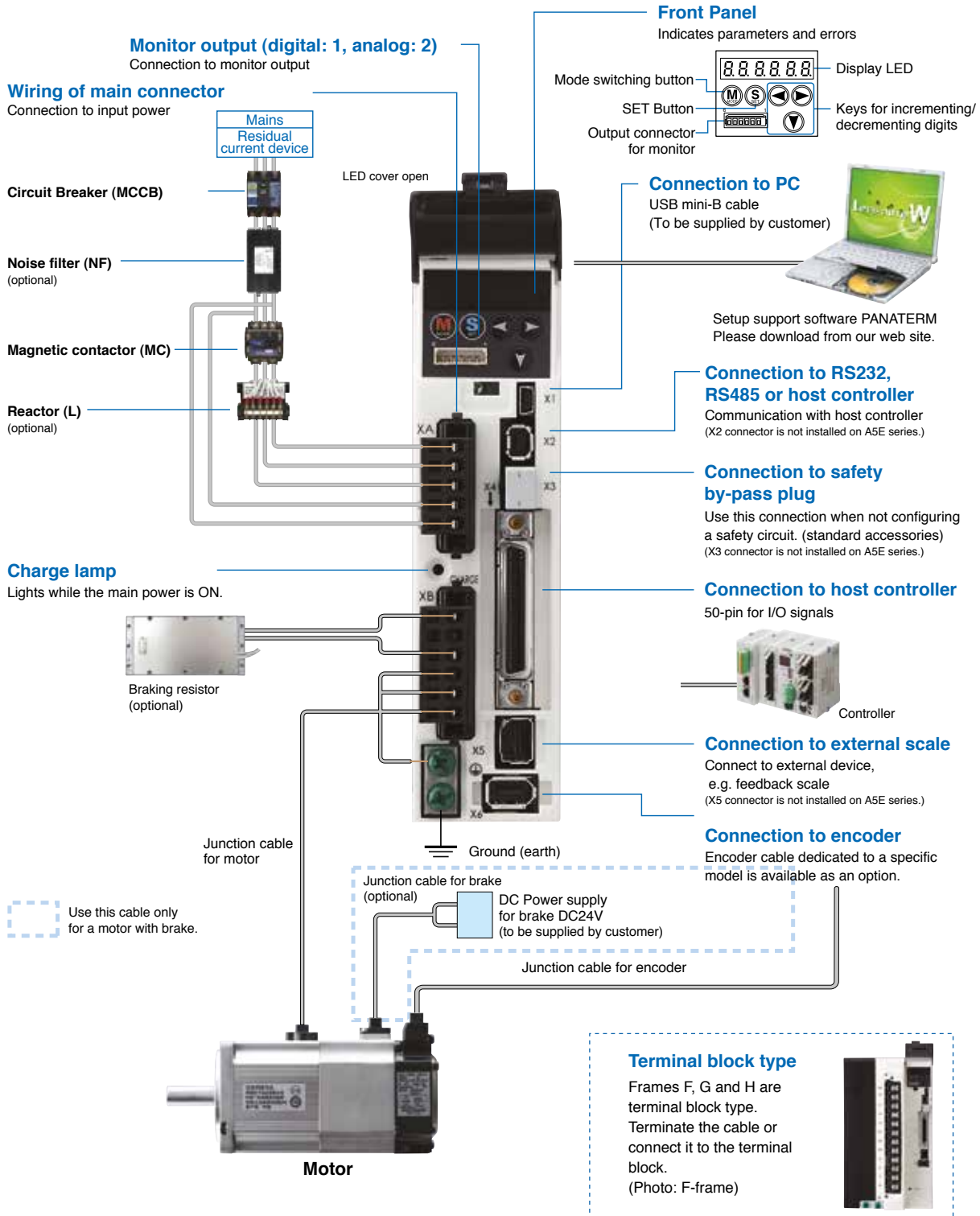

MINAS A5 series

The MINAS A5 series: Panasonic's standard AC servo drives.

The highly dynamic servo drives can be controlled by pulses or analog signals.

- Ultrafast response frequency: 2kHz bandwidth (velocity response)
- Pulse input and output with up to 4MHz
- Real-time autotuning function during operation
- 4 notch filters: manual/automatic
- 4 damping filters: manual/automatic
- PANATERM: Free software for configuration and motion simulation
- Conforms to the following safety standards: EN954-1(CAT3), ISO13849-1(PLd), EN61508(SIL2), EN62061(SIL2), EN61800-5-2(STO), IEC61326-3-1
- Full-closed control



Rated power	Driver MINAS A5E 230V AC	Drivers MINAS A5; A5N; A5B 230V AC	Drivers MINAS A5; A5N; A5B 3x380V AC	Frame
50/100W	MADHT1505E	MADHT1505***	-	A
200W	MADHT1507E	MADHT1507***		B
400W	MBDHT2510E	MBDHT2510***		C
750W	MCDHT3520E	MCDHT3520***	MDDHT2412*** MDDHT3420***	D
1kW	-	MDDHT5540***		MEDHT4430*** MFDHT5440***
1.5kW		MFDHTA464***	MGDHTB4A2*** MHDHTB4A2***	
2kW				-
3kW		-	-	
4/5kW				-
7.5kW		-	-	
11/15kW				-
-		-	-	

Ordering code for drivers

M A D H T 1 5 0 5 * . * . *

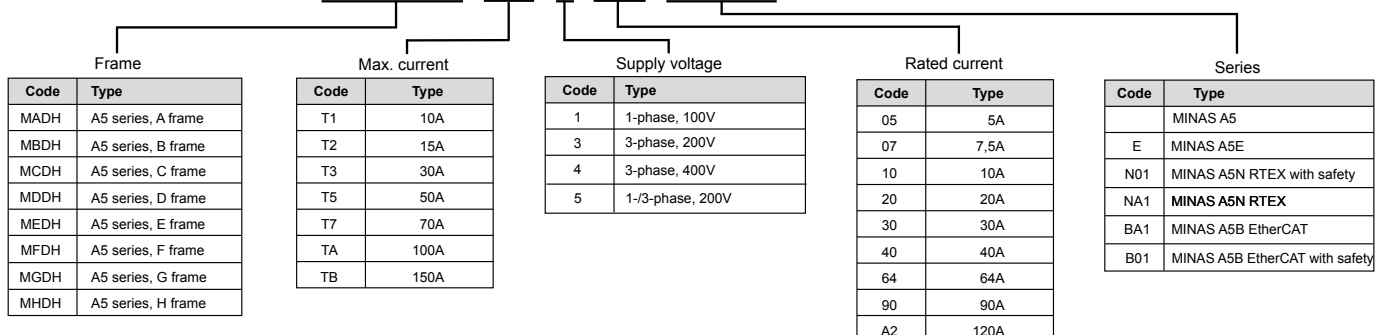

MINAS A5 network series

Thanks to its high transmission speed and sampling rate, RTEX (Realtime Express), the fast, real-time Ethernet bus for automation, is particularly well suited for highly dynamic single and multiple axes positioning tasks. The communication between master and slaves happens in real-time.

EtherCAT (Ethernet for Control Automation Technology) offers similar excellent features like RTEX. However, EtherCAT is an open, standardized field bus that allows an open data exchange with all other servo drivers which have an EtherCAT interface.



Features	MINAS A5N	MINAS A5B
Real-time communication 100Mbit/s	RTEX protocol	CAN over EtherCAT (CoE)
Supports position, velocity and torque control	✓	✓
Manual and automatic vibration suppression (adjustable in the driver)	✓	✓
Full control of	up to 32 axes	up to 64 axes
Conforms to the following safety standards: EN954-1(CAT3), ISO13849-1 (PLd), EN61508(SIL2), EN62061(SIL2), EN61800-5-2(STO), IEC61326-3-1	✓	✓
Easy wiring using standard Ethernet cables (CAT5e, up to 100m between units)	✓	✓
Positioning units for	FPΣ (Sigma), FP2SH	FP7

Easy mounting and reliable connections thanks to loop wiring

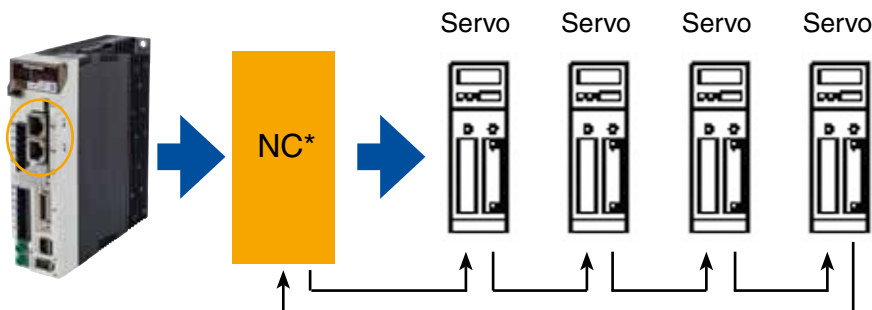

* NC: Numerical control (servo driver, positioning unit)

External encoders for full-closed control

Using an external encoder ensures high-precision positioning. For most applications, positioning with a motor encoder works fine. However, mechanical parts may cause slight deviations that the motor encoder cannot control. This is where an external encoder or a linear scale is needed. They help to compensate even small inaccuracies so that positioning practically always works correctly.

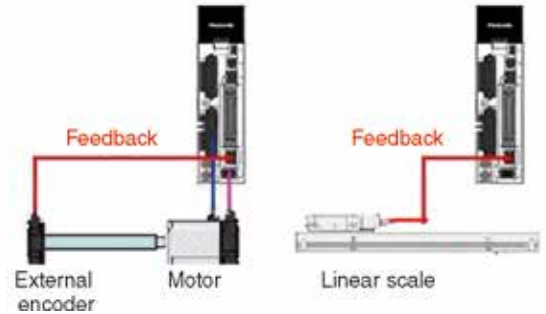

Real-time auto-gain tuning

If this function is activated, tuning is performed automatically upon completion of several operations. When the response frequency has been adjusted, simple tuning results in a change to a single parameter value. Fine-tuning can be carried out by activating the gain adjustment mode in the setup software. The automatic vibration suppression function minimizes damage to the equipment. Additional mode and stiffness parameters enable easy response frequency optimization for specific machine types such as high-friction, belt-driven machines or machines with low-friction ball screw drives.



Manual and automatic notch filters

Highly sensitive notch filters eliminate the need to monitor troublesome vibration frequencies. By automatically detecting vibration and defining a simple auto-gain setting, the MINAS A5's filters greatly reduce interference and vibration caused by equipment resonance. For depth adjustment, the A5 features a total of four notch filters, two of which share the auto setup. The setup frequency range for the filters is 50–5000Hz.

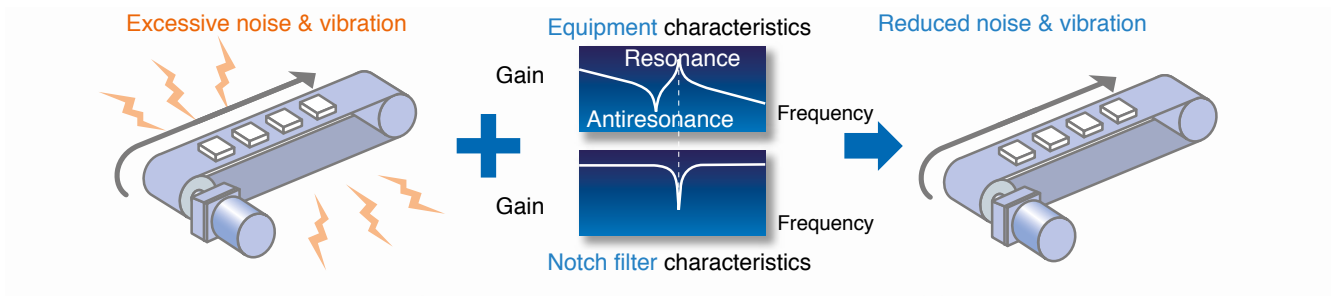
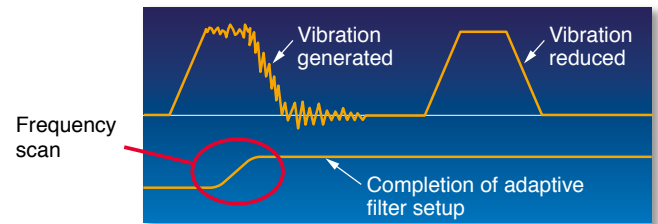

Manual and automatic damping filters

Damping filters that can be set automatically suppress the equipment's resonance and the natural vibration frequency component of the command input, which greatly reduces axis vibration at machine stoppage. The number of damping filters has been increased to four from the conventional two; of these four, two are for simultaneous use. The available frequency range has been extended significantly from 1 to 200Hz.

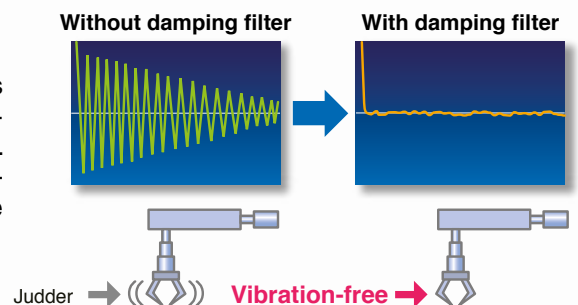

Low cogging torque

Compared to competitor products, the MINAS A5 achieves the industry's most stable speed and lowest cogging torque by minimizing pulse width. This was made possible by a new design featuring a 10-pole rotor for the motor as well as magnetic field analysis. With the reduction in torque variation, the MINAS A5's speed, stability and positioning behavior have been markedly improved.

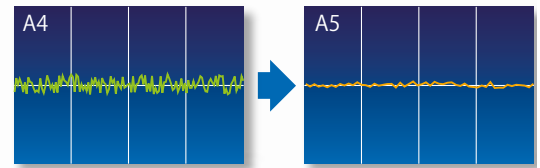

Vibration reduced to only **1/8**

Software tool PANATERM with motion simulation

PANATERM reads response frequency data from the actual machine. A simplified simulation function allows you to check gain and filter effects without adjusting the actual equipment.

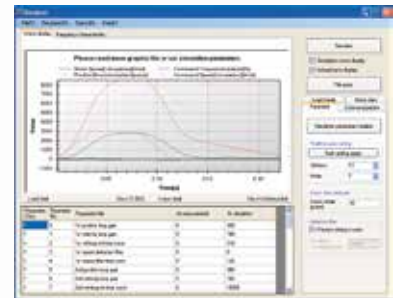

3-step control setting

Control parameters are activated according to the operating condition (deceleration during operation, stopping during fast positioning, standstill). By controlling the motion it is possible to perform even faster positioning with less vibration.

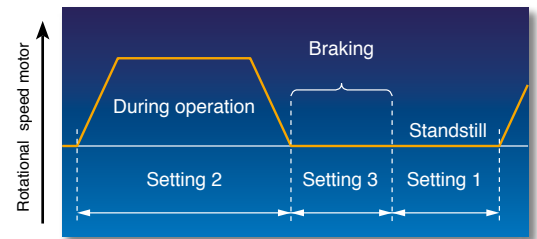

Integrated safety function (STO)

To insulate the motor power, MINAS A5 servo drivers feature independent, hardware-based, redundant circuits. Magnetic breakers prescribed for machines by the Low-Voltage Directive are thereby unnecessary. This saves both space and money. The servo driver's safety functions fulfill the following safety standards: EN954-1(CAT3), ISO13849-1 (PLd), EN61508 (SIL2), EN62061(SIL2), EN61800-5-2(STO), IEC61326-3-1.

Dynamic brake:

The dynamic brake is activated in case of an emergency, i.e. when:

- The main switch has been turned off,
- The input SRV-OFF is not active,
- One of the protective functions is activated or,
- The input INH is not active.

Torque limit

Torque limit is an indispensable function for torque-controlled applications or generally for protection against mechanical damages.

Possible settings:

- As specified by analog value,
- Different values for positive and negative direction,
- 2 digital input points for fixed values.

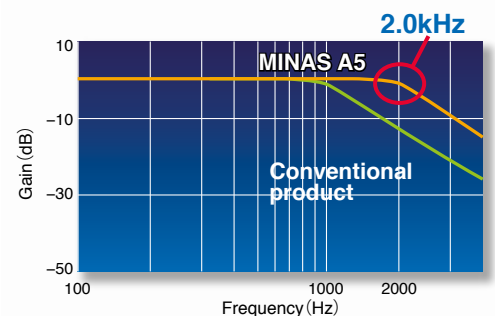
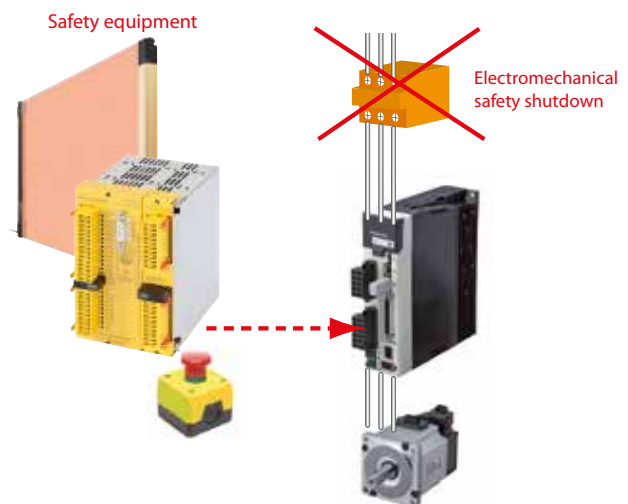

Overview MINAS A5 motors and accessories

Overview MINAS A5 motors and accessories															
Rated power W	Max. torque Nm	Rated rotational speed (max.) rpm	Motor					Encoder	Driver Type	Cabel				Filter EMC filter	Braking resistor Type
			Motor type	Holding brake	IP67 degree of protection	Key shaft	Motor cable			Encoder cable					
										For motors with- out holding brake	For motors with holding brake	20 bit incremental	17 bit absolute		
Low inertia 200V AC class															
Low inertia	50	0,16 (0,48)	3000 (6000)	MSME5AZG1U			x	20-bit incremental encoder 1048576ppr	MADHT1505	MFMCAB0□□0WJD	--	MFCEA0□□0WJD	MFCEA0□□0GJE (with battery box)	FN2080-6-06 or FS21238607	BWD250100
	100	0,32 (0,95)	3000 (6000)	MSME5AZG1V	x	x	x				MFMCB80□□0PJT*				
				MSME012G1U			x				x				
	200	0,64 (1,91)	3000 (6000)	MSME012G1V	x	x	x				MFMCB80□□0PJT*				
				MSME022G1U			x				x				
	400	1,3 (3,8)	3000 (6000)	MSME022G1V	x	x	x				MFMCB80□□0PJT*				
				MSME042G1U			x				x				
	750	2,4 (7,1)	3000 (6000)	MSME042G1V	x	x	x				MFMCB80□□0PJT*				
				MSME082G1U			x				x				
	1000	3,18 (9,55)	3000 (5000)	MSME082G1V	x	x	x				MFMCB80□□0PJT*				
MSME102G1G						x	x	--							
1500	4,77 (13,3)	3000 (5000)	MSME102G1H	x	x	x	MFMCB80□□2GCD								
			MSME152G1G			x	x	--							
Low inertia 400V AC class															
Medium inertia	1000	3,18 (9,55)	3000 (5000)	MSME104G1G			x	20-bit incremental encoder 1048576ppr	MDDHT3420	MFMCAD0□□2GCD	--	MFCEA0□□0GTD	MFCEA0□□0GTE (with battery box)	FN3268-7-44	BWD500150
	1500	4,77 (13,3)	3000 (5000)	MSME104G1H	x	x	x				MFMCCE0□□2HCD				
				MSME154G1G			x				x				
	2000	6,37 (19,1)	3000 (5000)	MSME154G1H	x	x	x				MFMCCE0□□2HCD				
				MSME204G1G			x				x				
	3000	9,55 (28,6)	3000 (5000)	MSME204G1H	x	x	x				MFMCCE0□□2HCD				
				MSME304G1G			x				x				
	4000	12,7 (38,2)	3000 (4500)	MSME304G1H	x	x	x				MFMCCE0□□2HCD				
				MSME404G1G			x				x				
	5000	15,9 (47,7)	3000 (4500)	MSME404G1H	x	x	x				MFMCCE0□□2HCD				
MSME504G1G						x	x	--							
Medium inertia 200V AC class															
Medium inertia	1000	4,7 (14,3)	2000 (3000)	MDME102G1G			x	20-bit increm. encoder	MDDHT3530	MFMCDD0□□2GCD	--	MFCEA0□□0GTD	MFCEA0□□0GTE (mit Batteriebox)	FN2080-10-06	BWD500035
	1500	7,16 (21,5)	2000 (3000)	MDME102G1H	x	x	x				MFMCCE0□□2HCD				
				MDME152G1G			x				x				
	2000	9,55 (28,6)	2000 (3000)	MDME152G1H	x	x	x				MFMCCE0□□2HCD				
				MDME204G1G			x				x				
	3000	14,3 (43,0)	2000 (3000)	MDME204G1H	x	x	x				MFMCCE0□□2HCD				
				MDME304G1G			x				x				
	4000	19,1 (57,3)	2000 (3000)	MDME304G1H	x	x	x				MFMCCE0□□2HCD				
				MDME404G1G			x				x				
	5000	23,9 (71,6)	2000 (3000)	MDME404G1H	x	x	x				MFMCCE0□□2HCD				
MDME504G1G						x	x	--							
7500	47,8 (119)	1500 (2000)	MDME504G1H	x	x	x	MFMCCE0□□2HCD								
			MDME754G1G			x	x	--							
High inertia 200V AC class															
High inertia	200	0,64 (1,91)	3000 (5000)	MHMD022G1U		IP65	x	20-bit increm. encoder	MADHT1507	MFMCAB0□□0EEL	--	MFCEA0□□0EAM	MFCEA0□□0EAE (with battery box)	FN2080-6-06 or FS21238607	BWD250072
	400	1,3 (3,8)	3000 (5000)	MHMD022G1V	x	IP65	x				MFMCB80□□0GET*				
				MHMD042G1U			IP65				x				
	750	2,4 (7,1)	3000 (4500)	MHMD042G1V	x	IP65	x				MFMCB80□□0GET*				
				MHMD082G1U			IP65				x				
	1500	4,77 (14,3)	2000 (3000)	MHMD082G1V	x	IP65	x				MFMCB80□□0GET*				
				MHME104G1G			x				x				
	2000	9,55 (28,6)	2000 (3000)	MHME104G1H	x	x	x				MFMCCE0□□2HCD				
				MHME154G1G			x				x				
	3000	14,3 (43,0)	2000 (3000)	MHME154G1H	x	x	x				MFMCCE0□□2HCD				
MHME204G1G						x	x	--							
4000	19,1 (57,3)	2000 (3000)	MHME204G1H	x	x	x	MFMCCE0□□2HCD								
			MHME304G1G			x	x	--							
5000	23,9 (71,6)	2000 (3000)	MHME304G1H	x	x	x	MFMCCE0□□2HCD								
			MHME404G1G			x	x	--							
7500	47,8 (119)	1500 (2000)	MHME404G1H	x	x	x	MFMCCE0□□2HCD								
			MHME504G1G			x	x	--							
High inertia 400V AC class															
High inertia	1000	4,77 (14,3)	2000 (3000)	MHME104G1G			x	20-bit incremental encoder 1048576ppr	MDDHT2412	MFMCDD0□□2GCD	--	MFCEA0□□0GTD	MFCEA0□□0GTE (with battery box)	FN3268-7-44	BWD500150
	1500	7,16 (21,5)	2000 (3000)	MHME104G1H	x	x	x				MFMCCE0□□2HCD				
				MHME154G1G			x				x				
	2000	9,55 (28,6)	2000 (3000)	MHME154G1H	x	x	x				MFMCCE0□□2HCD				
				MHME204G1G			x				x				
	3000	14,3 (43,0)	2000 (3000)	MHME204G1H	x	x	x				MFMCCE0□□2HCD				
				MHME304G1G			x				x				
	4000	19,1 (57,3)	2000 (3000)	MHME304G1H	x	x	x				MFMCCE0□□2HCD				
				MHME404G1G			x				x				
	5000	23,9 (71,6)	2000 (3000)	MHME404G1H	x	x	x				MFMCCE0□□2HCD				
MHME504G1G						x	x	--							
7500	47,8 (119)	1500 (2000)	MHME504G1H	x	x	x	MFMCCE0□□2HCD								
			MHME754G1G			x	x	--							

* For motors with a holding brake < 1kW you need two cables: one for the motor, one for the brake.

□□ = Length

01 = 1m

10 = 10m

			Frame	MINAS A5E	MINAS A5, A5N, A5B
			Input power	Main circuit	200V
Control circuit	A, B, C, D	1-phase, 200–240V (+10%, -15%), 50/60Hz			
		E, F		1-phase, 200-230V (+10%, -15%), 50/60Hz	
Main circuit	400V	D, E, F, G, H		–	3-phase, 380–480V (+10%, -15%), 50/60Hz
Control circuit		D, E, F, G, H	–	24V DC (±15%)	
Operating conditions	Temperature		0–50°C, storage temperature: -20 to +65°C (max. temperature 80°C for 72h)		0-55°C, storage temperature: -20 to +65°C (max. temperature 80°C for 72h)
	Ambient humidity		Operation and storage: 20–85% RH (non-condensing)		
	Altitude		Max. 1000m above sea level		
	Vibration		Max. 5,88m/s ² , 10–60Hz (no continuous use at resonance frequency)		
Control method			IGBT sinusoidal PWM		
Encoder	Incremental (default)		20-bit incremental encoder (resolution 1048576ppr)		
	Absolute		–	17-bit absolute encoder on request (resolution 131072ppr)	
External feedback scale	A/B phase		–	Initialization signal differential input	
	Serial		–	Compatible with Mitutoyo (AT500, ST771)	
Control signals	Input points		10		
	Output points		6		
Analog/digital signals	Input points		–	3 (16-bit A/D: 1, 12-bit A/D: 2)	
	Output points		2		
Pulse signals	Input points		2 line driver		
	Output points		3 line driver (A, B and Z-phase), 1 open collector (Z-phase)		
Interface	USB		Interface to PC, etc.		
	RS232		–	1:1 communication	
	RS485		–	1:n communication with up to 31 axes via host (FP series PLC)	
Safety functions			–	IEC61800-5-2 STO	
Front panel			5 buttons (MODE, SET, UP, DOWN, SHIFT), LED (6 digits), analog output	5 buttons (MODE, SET, UP, DOWN, SHIFT), LED (6 digits), analog output, digital output	
Braking resistor			A, B, G, and H frame: only external braking resistor C–F frame: built-in braking resistor (external braking resistor also possible)		
Dynamic brake			A–G frame: built-in braking resistor (G frame: external braking resistor can be implemented) H frame: only external braking resistor		
Control mode			Position control	7 different control modes 1. Position control, 2. Velocity control, 3. Torque control, 4. Position/velocity control, 5. Position/torque control, 6. Velocity/torque control, 7. Full-closed control	

Driver functions

		MINAS A5E		MINAS A5, A5N, A5B	
Position control	Control input		1. Clear deviation counter, 2. Command pulse inhibition, 3. Electronic gear switching, 4. Damping control switching		
	Control output		Positioning complete etc.		
	Pulse input	Line driver A	500kpps		
		Open collector	200kpps		
		Line driver B	4Mpps		
		Signal format	Differential input/square-wave pulse		
		Electronic gear	Scaling of pulse frequency from 1/1000 to 1000 times		
	Smoothing filter		Primary delay filter or FIR filter, customizable		
	Analog input	Torque limit command	-	Individual torque limit for positive and negative direction	
	Instantaneous speed observer		Available		
Damping control		Available			
Velocity control	Control input		-	1-3. Selection of internal velocities, 4. Zero speed clamp	
	Control output		-	Set velocity has been reached, etc.	
	Analog input	Velocity command	-	Velocity and direction	
		Torque limit command	-	Available	
	Velocity range		-	1-6000rpm	
	Internal velocity command		-	8 velocity set values	
	Smooth start-up and stopping		-	Individual setup of acceleration and deceleration from 0 to 10s/1000rpm S-curve acceleration and deceleration ramp possible	
	Zero speed clamp		-	Available	
	Instantaneous speed observer		-	Available	
	Velocity control filter		-	Available	
Torque control	Control input		-	Zero speed clamp, Torque direction command etc.	
	Control output		-	Set torque has been reached (at predefined velocity)	
	Analog input	Velocity command	-	Set speed can be scaled	
		Speed limit function	-	Speed can be scaled	
Full-closed control	Control input		-	1. Clear deviation counter, 2. Command pulse inhibition, 3. Electronic gear switching, 4. Damping control switching	
	Control output		-	Full-closed control complete	
	Pulse input	Line driver A	-	500kpps	
		Open collector	-	200kpps	
		Line driver B	-	4Mpps	
		Signal format	-	Differential input/square-wave pulse	
		Electronic gear	-	Scaling of pulse frequency from 1/1000 to 1000 times	
	Smoothing filter		-	Primary delay filter or FIR filter, customizable	
Analog input	Torque limit command	-	Torque limit available		
Setup range of division/multiplication of feedback scale		-	From 1/40 to 160 times		
Other features	Autotuning		Automatic adjustment of the driver's rigidity to the vibration behavior of the mechanical parts and changes to the load		
	Division of encoder feedback pulse		Any value up to the maximal resolution of the encoder		
	Protective function	Error messages causing switch-off	Overvoltage, undervoltage, overspeed, overload, overheat, overcurrent, encoder error, etc.		
		Error messages requiring acknowledgement	Excessive position deviation, command pulse division error, EEPROM error, etc.		
Alarm history		Can be logged for reference			

Driver dimensions

Frame A, B, C

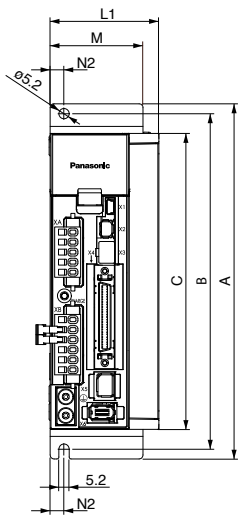

Rack mounting (mounting bracket optional)

Frame D

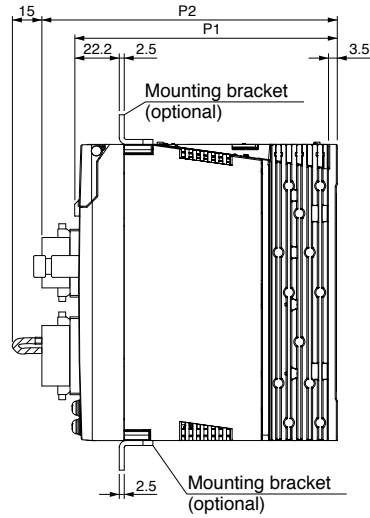
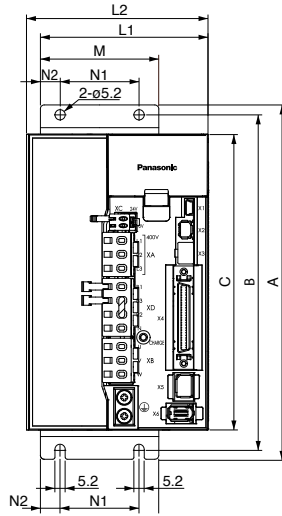

All dimensions are in mm

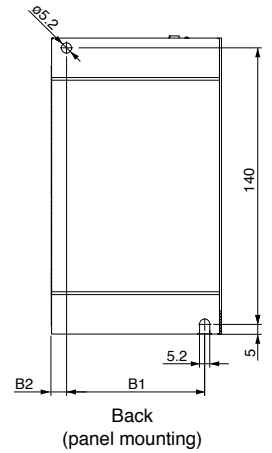

Frame E

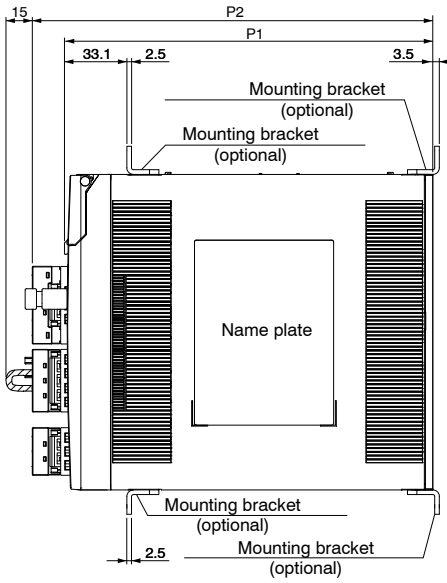
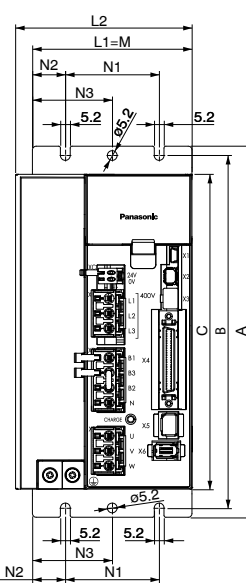

Frame F

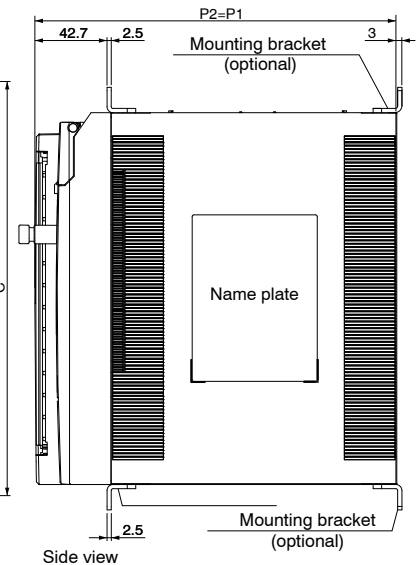
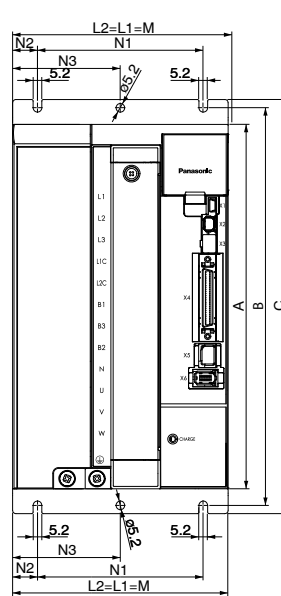

Frame	Voltage	Width		Mounting bracket			Height			Depth		Control panel		Weight	
		L1	L2	M	N1	N2	N3	A	B	C	P1	P2	B1		B2
A	200V	40	-	40	-	7	-	180	170	150	133	151	28	6	0.8kg
B	200V	55	-	47	-	7	-	180	170	150	133	151	43	6	1.0kg
C	200V	65	-	40	-	20	-	180	170	150	173	191	50	7.5	1.6kg
D	200V	85	86	60	40	10	-	180	170	150	173	191	70	8.5	1.8kg
	400V	85	92	60	40	10	-	180	170	150	173	191	70	7.5	1.9kg
E	200V	85	86	85	50	17.5	42.5	198	188	168	196	212	*	*	2.7kg
	400V	85	94	85	50	17.5	42.5	198	188	168	196	212	*	*	2.7kg
F	200V	130	130	130	100	15	65	250	240	220	214	-	*	*	4.8kg
	400V	130	130	130	100	15	65	250	240	220	214	-	*	*	4.7kg

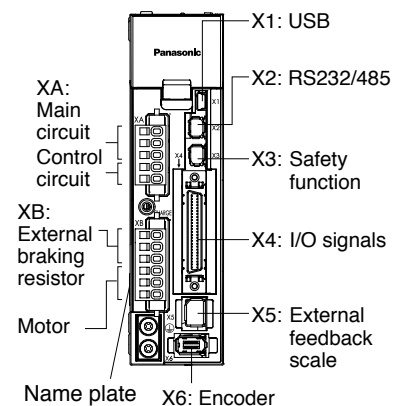

* For the dimensions, please refer to the data sheet of the mounting bracket

Dimensions of drivers

Frame G

All dimensions are in mm

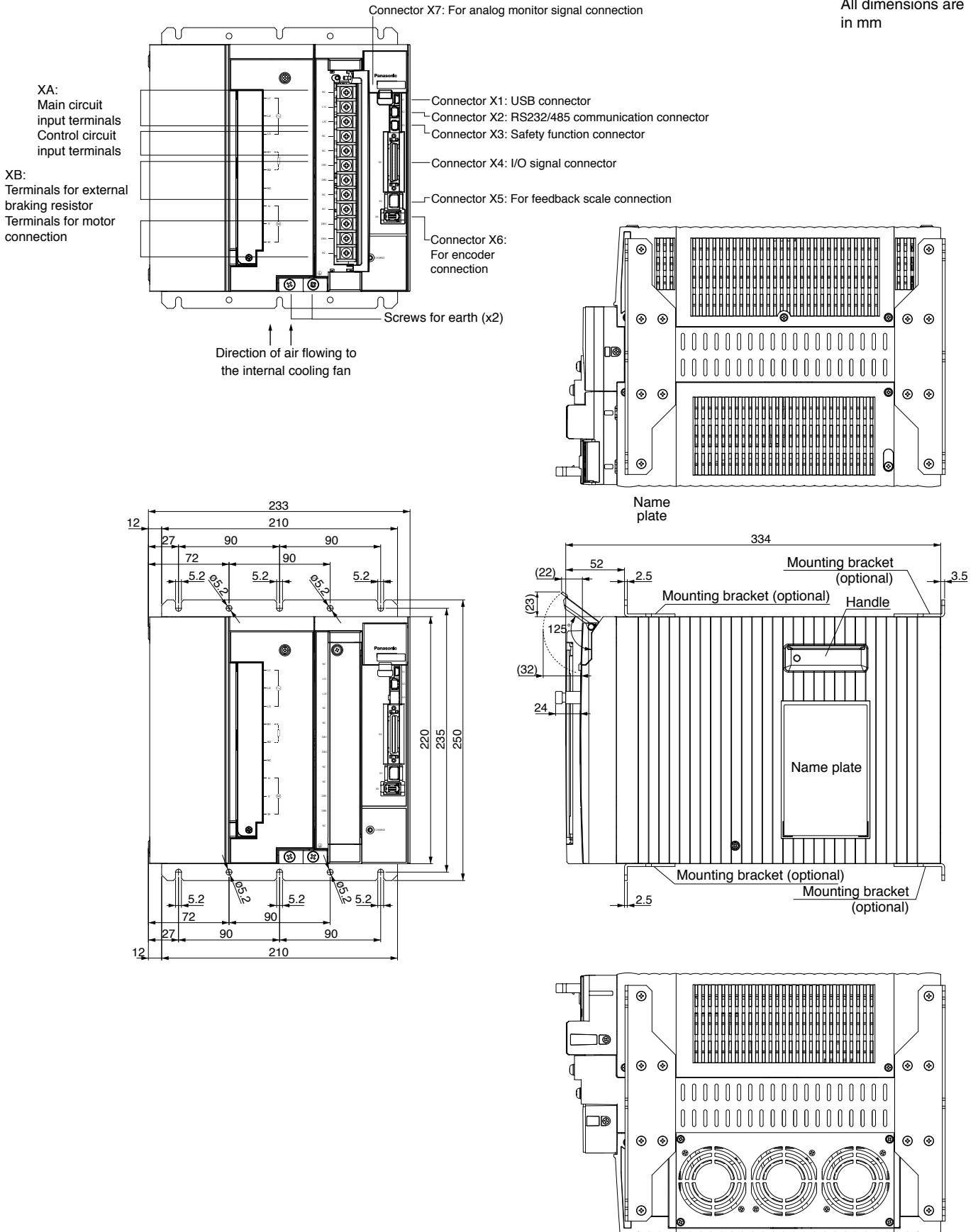

Frame H

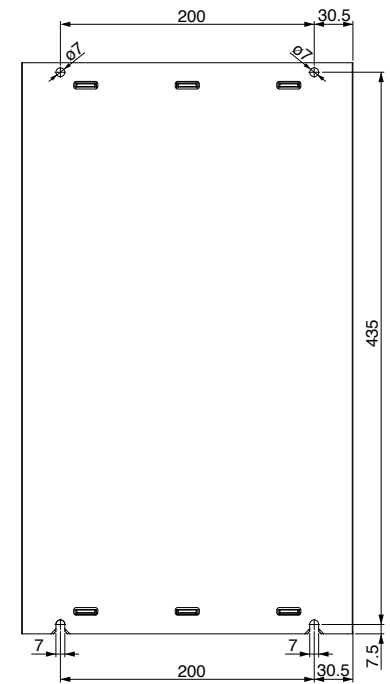
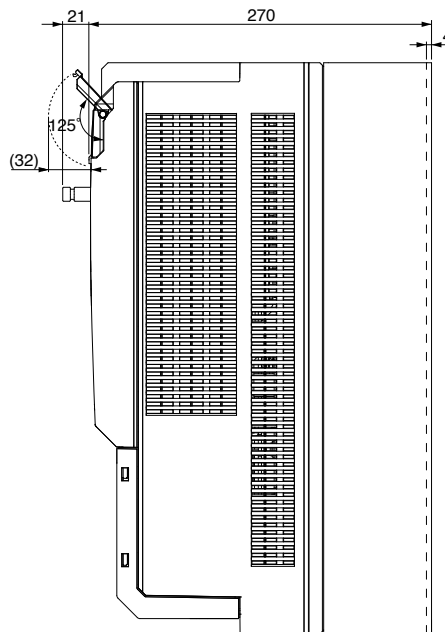
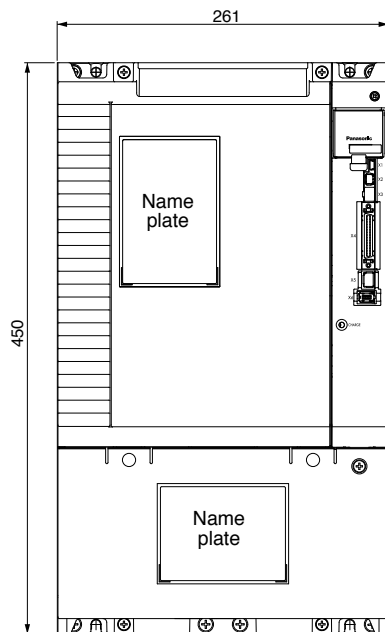
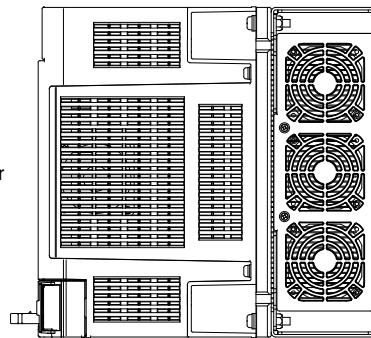
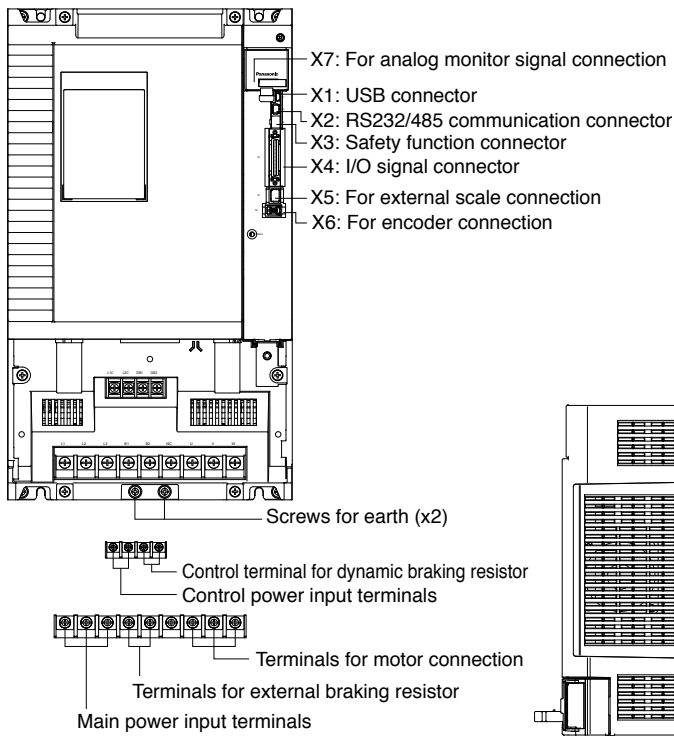

↑ ↑
 Direction of air flowing to the
 internal cooling fan

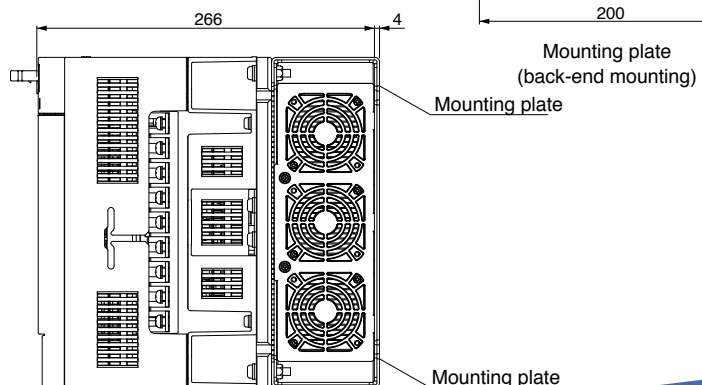

MINAS A5 motor specifications

MSME (low inertia) 50–1500W 200V AC									
Motor		MSME5AZG1□	MSME012G1□	MSME022G1□	MSME042G1□	MSME082G1□	MSME102G1□	MSME152G1□	
Rated power W		50	100	200	400	750	1000	1500	
Required power kVA		0.5		0.9	1.3	1.8	2.4	3.3	
Rated current A		1.1		1.5	2.4	4.1	6.6	8.2	
Max. current A o-p		4.7		6.5	10.2	17.4	28	35	
Rotational speed rpm	Rated rotational speed	3000							
	Max. rotational speed	6000				5000			
Weight kg	Without holding brake	0.31	0.46	0.78	1.2	2.3	3.5	4.4	
	With holding brake	0.51	0.66	1.2	1.6	3.1	4.5	5.4	
Torque Nm	Nominal	0.16	0.32	0.65	1.3	2.4	3.18	4.77	
	Maximal	0.48	0.95	1.91	3.8	7.1	9.55	13.3	
Encoder		20-bit incremental encoder resolution: 1048576ppr							
Braking resistor frequency times/min	With internal resistor	No limit							
	With external resistor	No limit							
Moment of inertia of rotor (x10 ⁻⁴ kg · m ²)	Without holding brake	0.025	0.051	0.14	0.26	0.87	2.03	2.84	
	With holding brake	0.027	0.054	0.16	0.28	0.97	2.35	3.17	
Recommended inertia ratio between load and rotor		Max. 30:1			Max. 20:1		Max. 15:1		
Operating conditions	Temperature (without frost)	0–40°C							
	Ambient humidity	20–85% RH (non-condensing)							
	Altitude	Max. 1000m above sea level							
	Vibration	49m/s ²							
Holding brake specifications (The holding brake is engaged when the power for the servo driver is shut off. Do not use the holding brake when the motor is in motion.)									
Static friction torque Nm		Min. 0.29		Min. 1.27		Min. 2.45		Min. 7.8	
Engaging time ms		Max. 35		Max. 50		Max. 70		Max. 50	
Releasing time ms		Max. 20		Max. 15		Max. 20		Max. 15	
Excitation current A DC		0.3		0.36		0.42		0.81 ±10%	
Releasing voltage V DC		Min. 1							
Excitation voltage V DC		24 ±5%							
Permissible load and thrust at output shaft									
During installation	Radial load,	147		392		686		980	
During operation	P-direction N*	68.6		245		392		490	
During installation	Axial thrust (push),	88		147		294		588	
During operation	A-direction N*	58.8		98		147		196	
During installation	Axial thrust (pull),	117.6		196		392		686	
During operation	B-direction N*	58.8		98		147		196	

MSME (low inertia) 1000–5000W 400V AC								
Motor		MSME104G1□	MSME154G1□	MSME204G1□	MSME304G1□	MSME404G1□	MSME504G1□	
Rated power W		1000	1500	2000	3000	4000	5000	
Required power kVA		1.8	2.3	3.3	4.5	6.8	7.5	
Rated current A		3.3	4.2	5.7	9.2	9.9	12	
Max. current A o-p		14	18	24	39	42	51	
Rotational speed rpm	Rated rotational speed	3000						
	Max. rotational speed	5000				4500		
Weight kg	Without holding brake	3.5	4.4	5.3	8.3	11	14	
	With holding brake	4.5	5.4	6.3	9.4	12.6	16	
Torque Nm	Nominal	3.18	4.77	6.37	9.55	12.7	15.9	
	Maximal	9.55	13.3	19.1	28.6	38.2	47.7	
Encoder		20-bit incremental encoder resolution: 1048576ppr						
Braking resistor frequency times/min	With internal resistor	No limit						
	With external resistor	No limit						
Moment of inertia of rotor (x10 ⁻⁴ kg · m ²)	Without holding brake	2.03	2.84	3.68	6.5	12.9	17.4	
	With holding brake	2.35	3.17	4.01	7.85	14.2	18.6	
Recommended inertia ratio between load and rotor		Max. 15:1						
Operating conditions	Temperature (without frost)	0–40°C						
	Ambient humidity	20–85% RH (non-condensing)						
	Altitude	Max. 1000m above sea level						
	Vibration	49m/s ²						
Holding brake specifications (The holding brake is engaged when the power for the servo driver is shut off. Do not use the holding brake when the motor is in motion.)								
Static friction torque Nm		Min. 7.8			Min. 11.8		Min. 16.2	
Engaging time ms		Max. 50			Max. 80		Max. 110	
Releasing time ms		Max. 15						
Excitation current A DC		0.81 ±10%						
Releasing voltage V DC		Min. 2						
Excitation voltage V DC		24 ±10%						
Permissible load and thrust at output shaft								
During installation	Radial load,	980						
During operation	P-direction N*	490			784			
During installation	Axial thrust (push),	588						
During operation	A-direction N*	196			343			
During installation	Axial thrust (pull),	686						
During operation	B-direction N*	196			343			

*For details, please refer to page 19.
□ = Motor type, please refer to page 10.

MDME (medium inertia) 1000–1500W 200V AC			
Motor		MDME102G1□	MDME152G1□
Rated power W		1000	1500
Required power kVA		1.8	2.3
Rated current A		5.7	9.4
Max. current A o-p		24	40
Rotational speed rpm	Rated rotational speed	2000	
	Max. rotational speed	3000	
Weight kg	Without holding brake	5.2	6.7
	With holding brake	6.7	8.2
Torque Nm	Nominal	4.77	7.16
	Maximal	14.3	21.5
Encoder		20-bit incremental encoder resolution: 1048576ppr	
Braking resistor frequency times/min	With internal resistor	No limit	
	With external resistor	No limit	
Moment of inertia of rotor (x10 ⁻⁴ kg · m ²)	Without holding brake	4.6	6.7
	With holding brake	5.9	7.99
Recommended inertia ratio between load and rotor		Max. 10:1	
Operating conditions	Temperature (without frost)	0–40°C	
	Ambient humidity	20–85% RH (non-condensing)	
	Altitude	Max. 1000m above sea level	
	Vibration	49m/s ²	
Holding brake specifications (The holding brake is engaged when the power for the servo driver is shut off. Do not use the holding brake when the motor is in motion.)			
Static friction torque Nm		Min. 4.9	Min. 13.7
Engaging time ms		Max. 80	Max. 100
Releasing time ms		Max. 70	Max. 50
Excitation current A DC		0.59 ±10%	0.79 ±10%
Releasing voltage V DC		Min. 2	
Excitation voltage V DC		24 ±10%	
Permissible load and thrust at output shaft			
During installation	Radial load,	980	
During operation	P-direction N*	490	
During installation	Axial thrust (push),	588	
During operation	A-direction N*	196	
During installation	Axial thrust (pull),	686	
During operation	B-direction N*	196	

MDME (medium inertia) 2000–15000W 400V AC									
Motor		MDME204G1□	MDME304G1□	MDME404G1□	MDME504G1□	MDME754G1□	MDMEC14G1□	MDMEC54G1□	
Rated power W		2000	3000	4000	5000	7500	11000	15000	
Required power kVA		3.3	4.5	6.8	7.5	11	17	22	
Rated current A		5.9	8.7	10.6	13	22	27.1	33.1	
Max. current A o-p		25	37	45	55	83	101	118	
Rotational speed rpm	Rated rotational speed	2000				1500			
	Max. rotational speed	3000				2000			
Weight kg	Without holding brake	8	11	15.5	18.6	36.4	52.7	70.2	
	With holding brake	9.5	12.6	18.7	21.8	40.4	58.9	76.3	
Torque Nm	Nominal	9.55	14.3	19.1	23.9	47.8	70	95.5	
	Maximal	28.6	43.0	57.3	71.6	119	175	224	
Encoder		20-bit incremental encoder resolution: 1048576ppr							
Braking resistor frequency times/min	With internal resistor	No limit			120	No limit			
	With external resistor	No limit							
Moment of inertia of rotor (x10 ⁻⁴ kg · m ²)	Without holding brake	8.72	12.9	37.6	48	101	212	302	
	With holding brake	10	14.2	38.6	48.8	107	220	311	
Recommended inertia ratio between load and rotor		Max. 10:1				Max. 1:1			
Operating conditions	Temperature (without frost)	0–40°C							
	Ambient humidity	20–85% RH (non-condensing)							
	Altitude	Max. 1000m above sea level							
	Vibration	49m/s ²				24.5m/s ²			
Holding brake specifications (The holding brake is engaged when the power for the servo driver is shut off. Do not use the holding brake when the motor is in motion.)									
Static friction torque Nm		Min. 13.7	Min. 16.2	Min. 24.5	Min. 58.8	Min. 100			
Engaging time ms		Max. 100	Max. 110	Max. 80	Max. 150	Max. 300			
Releasing time ms		Max. 50		Max. 25	Max. 50	Max. 140			
Excitation current A DC		0.79 ±10%	0.90 ±10%	1.3 ±10%	1.4 ±10%	1.08 ±10%			
Releasing voltage V DC		Min. 2							
Excitation voltage V DC		24 ±5%							
Permissible load and thrust at output shaft									
During installation	Radial load,	980			1666	2058	4508		
During operation	P-direction N*	490			784	1176	2254		
During installation	Axial thrust (push),	588			784	980	1470		
During operation	A-direction N*	196			343	490	686		
During installation	Axial thrust (pull),	686			980	1176	1764		
During operation	B-direction N*	196			343	490	686		

*For details, please refer to page 19.
□ = Motor type, please refer to page 10.

MINAS A5 motor specifications

MHMD (high inertia) 200–750W 200V AC			
Motor		MHMD022G1□	MHMD042G1□
Rated power W		200	400
Required power kVA		0.5	0.9
Rated current A		1.6	2.6
Max. current A o-p		6.9	11
Rotational speed rpm	Rated rotational speed	3000	
	Max. rotational speed	5000	
Weight kg	Without holding brake	0.96	1.4
	With holding brake	1.4	1.8
Torque Nm	Nominal	4.77	7.16
	Maximal	14.3	21.5
Encoder		20-bit incremental encoder resolution: 1048576ppr	
Braking resistor frequency times/min	With internal resistor	No limit	
	With external resistor	No limit	
Moment of inertia of rotor (x10 ⁻⁴ kg · m ²)	Without holding brake	0.42	0.67
	With holding brake	0.45	0.7
Recommended inertia ratio between load and rotor		Max. 30:1	Max. 20:1
Operating conditions	Temperature (without frost)	0–40°C	
	Ambient humidity	20–85% RH (non-condensing)	
	Altitude	Max. 1000m above sea level	
	Vibration	49m/s ²	
Holding brake specifications (The holding brake is engaged when the power for the servo driver is shut off. Do not use the holding brake when the motor is in motion.)			
Static friction torque Nm		Min. 1.27	Min. 2.45
Engaging time ms		Max. 50	Max. 70
Releasing time ms		Max. 30	Max. 20
Excitation current A DC		0.36	0.42
Releasing voltage V DC		Min. 1	
Excitation voltage V DC		24 ±5%	
Permissible load and thrust at output shaft			
During installation	Radial load,	392	686
During operation	P-direction N*	245	392
During installation	Axial thrust (push),	147	294
During operation	A-direction N*	98	147
During installation	Axial thrust (pull),	196	392
During operation	B-direction N*	98	147

MHME (high inertia) 1000–7500W 400V AC							
Motor		MHME104G1□	MHME154G1□	MHME204G1□	MHME304G1□	MHME404G1□	MHME504G1□
Rated power W		1000	1500	2000	3000	4000	5000
Required power kVA		1.8	2.3	3.3	4.5	6.8	7.5
Rated current A		5.7	9.4	11.1	16	21	25.9
Max. current A o-p		24	40	47	68	83	110
Rotational speed rpm	Rated rotational speed	2000					
	Max. rotational speed	3000					
Weight kg	Without holding brake	6.7	8.6	12.2	16	18.6	23
	With holding brake	9.1	10.1	15.5	19.2	21.8	26.2
Torque Nm	Nominal	4.77	7.16	9.55	14.3	19.1	23.9
	Maximal	14.3	21.5	43.0	28.6	57.3	71.6
Encoder		20-bit incremental encoder resolution: 1048576ppr					
Braking resistor frequency times/min	With internal resistor	83	22	45	19	17	10
	With external resistor	No limit	130	142	42	125	76
Moment of inertia of rotor (x10 ⁻⁴ kg · m ²)	Without holding brake	24.7	37.1	57.8	90.5	112	162
	With holding brake	26	38.4	59.6	92.1	114	164
Recommended inertia ratio between load and rotor		Max. 5:1					
Operating conditions	Temperature (without frost)	0–40°C					
	Ambient humidity	20–85% RH (non-condensing)					
	Altitude	Max. 1000m above sea level					
	Vibration	49m/s ²					
Holding brake specifications (The holding brake is engaged when the power for the servo driver is shut off. Do not use the holding brake when the motor is in motion.)							
Static friction torque Nm		Min. 4.9	Min. 13.7	Min. 24.5			Min. 58.8
Engaging time ms		Max. 80	Max. 100	Max. 80			Max. 150
Releasing time ms		Max. 70	Max. 50	Max. 25			Max. 50
Excitation current A DC		0.59 ±10%	0.79 ±10%	1.3 ±10%			1.41 ±10%
Releasing voltage V DC		Min. 2					
Excitation voltage V DC		24 ±5%					
Permissible load and thrust at output shaft							
During installation	Radial load,	980	1666				2058
During operation	P-direction N*	490	784				1176
During installation	Axial thrust (push),	588	784				980
During operation	A-direction N*	196	343				490
During installation	Axial thrust (pull),	686	980				1176
During operation	B-direction N*	196	343				490

*For details, please refer to page 19.

□ = Motor type, please refer to page 10.

MSME5AZG1□

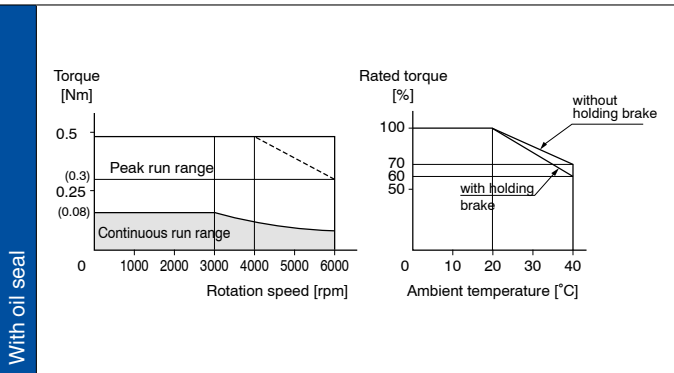

MSME012G1□

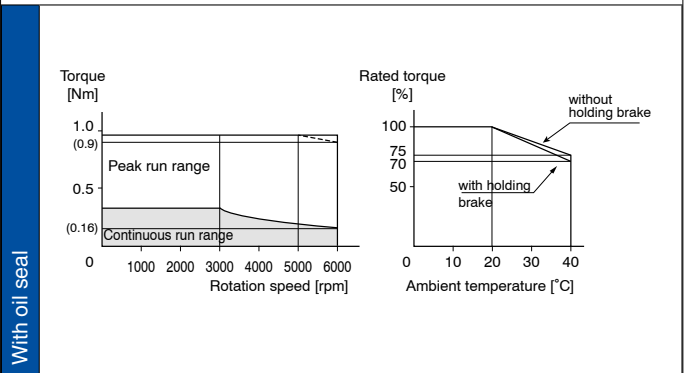

MSME022G1□

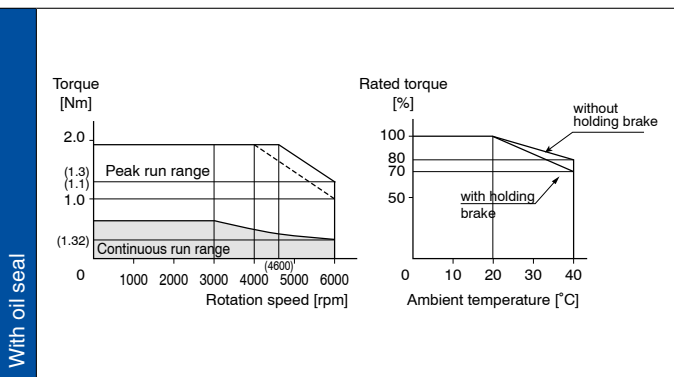

MSME042G1□

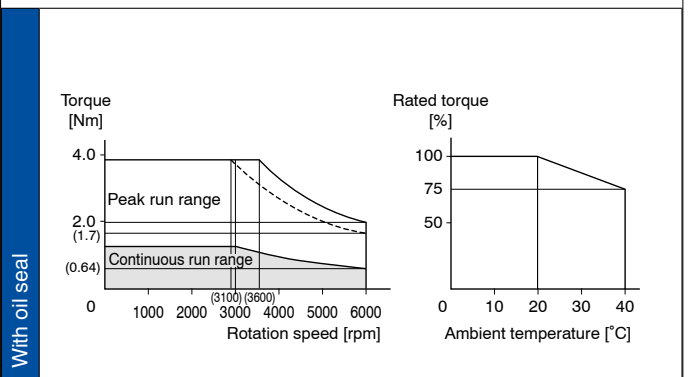

MSME082G1□

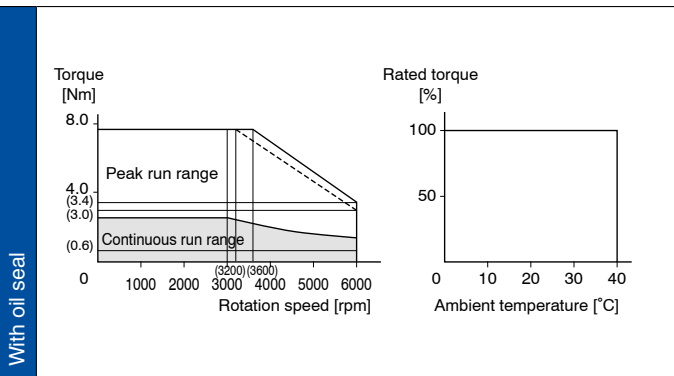

MSME102G1□

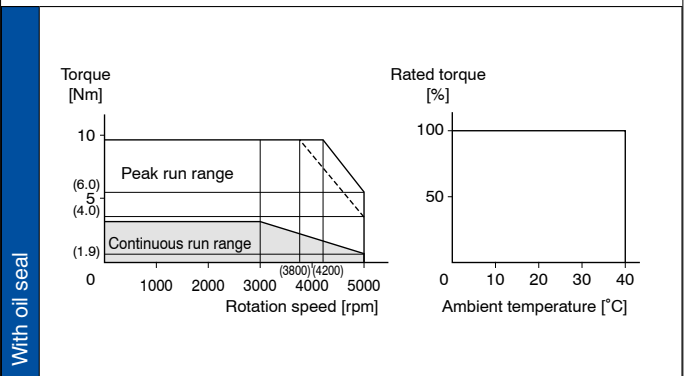

MSME152G1□

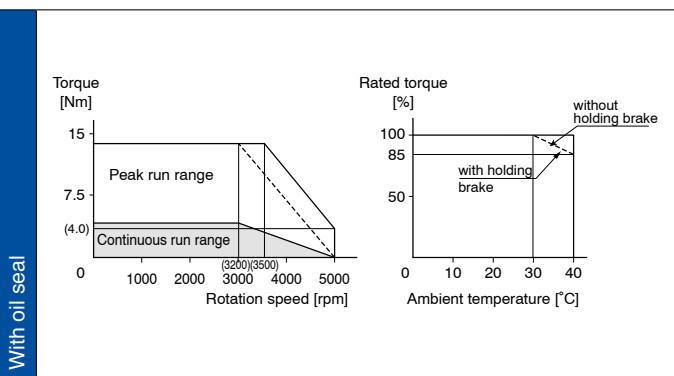

Permissible load at output shaft

Radiale Kraft, P-Richtung

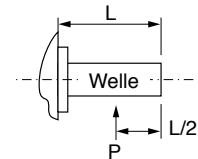

Axiale Kraft, A- und B-Richtung

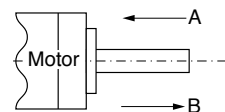

Torque characteristics

MSME104G1□

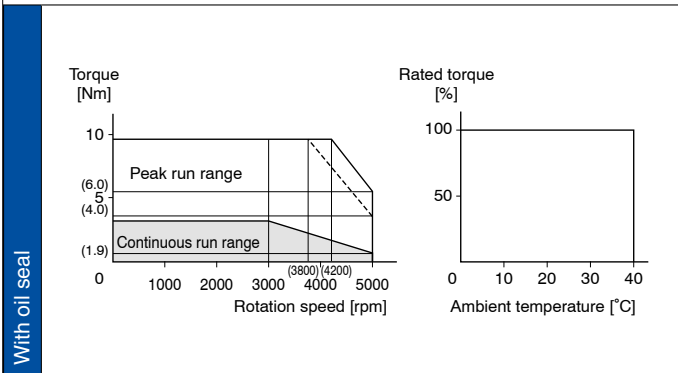

MSME154G1□

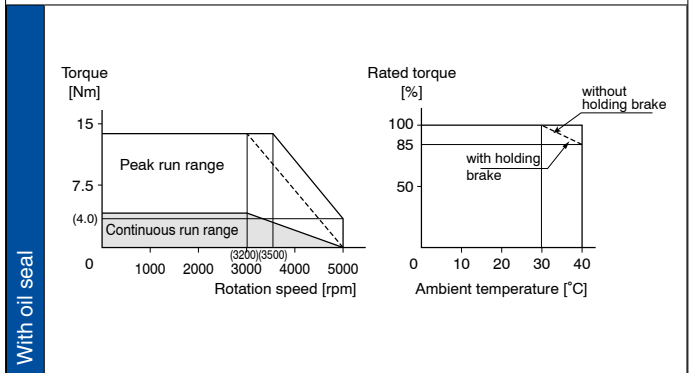

MSME204G1□

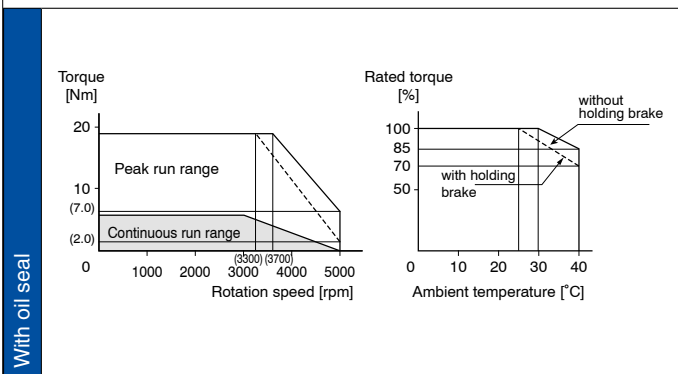

MSME304G1□

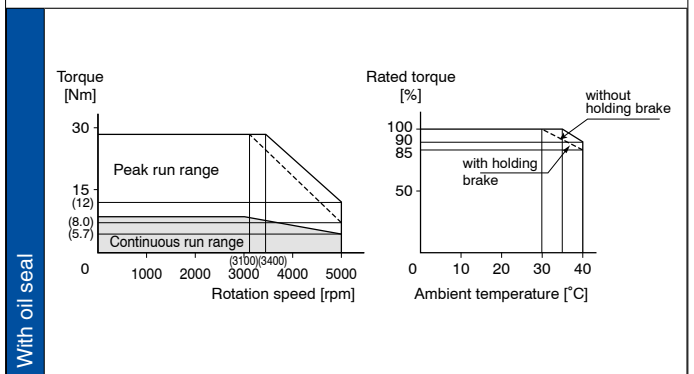

MSME404G1□

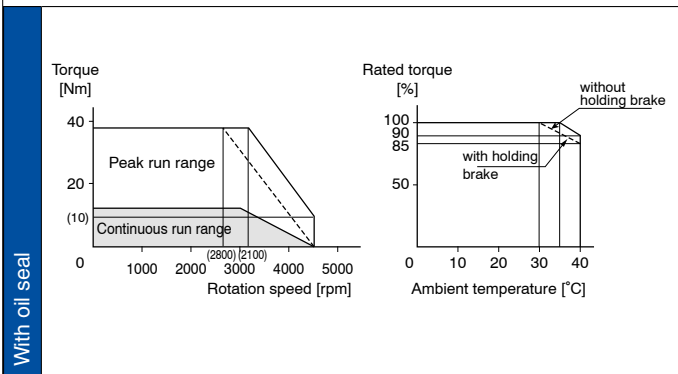

MSME504G1□

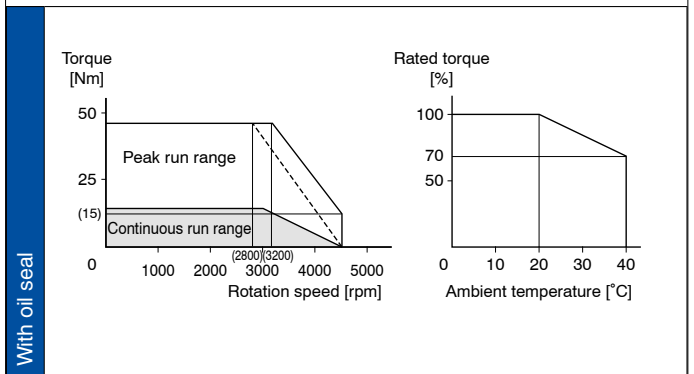

□ = Motor type, please refer to page 10.

MDME102G1□

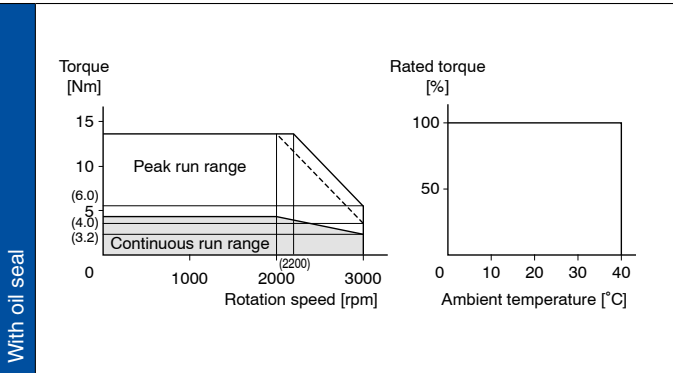

MDME152G1□

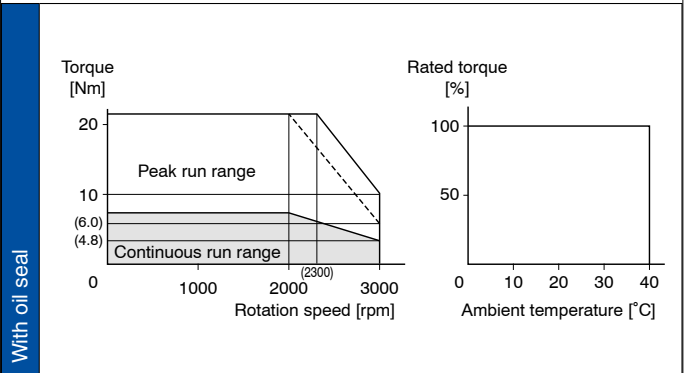

MDME204G1□

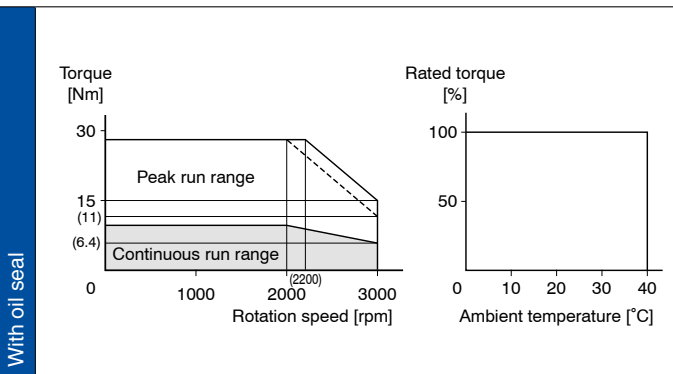

MDME304G1□

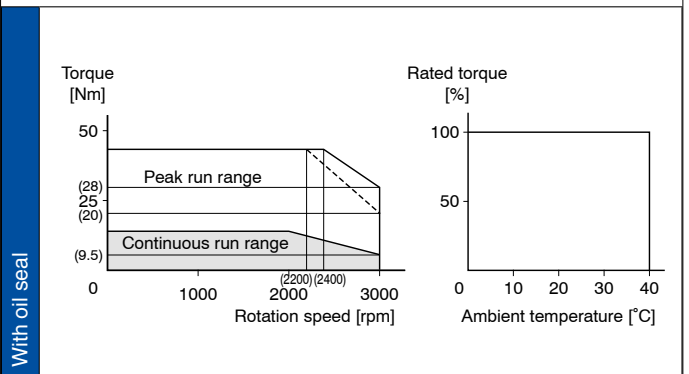

MDME404G1□

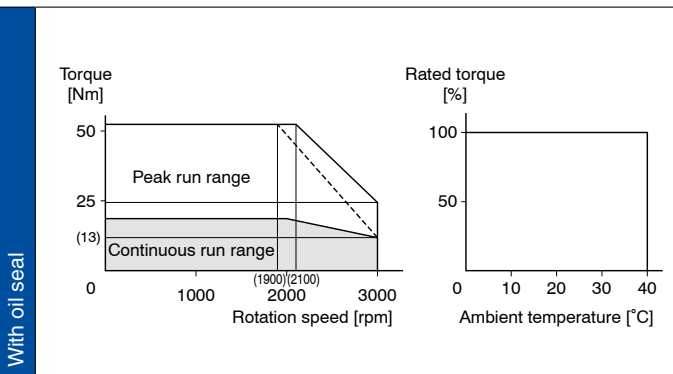

MDME504G1□

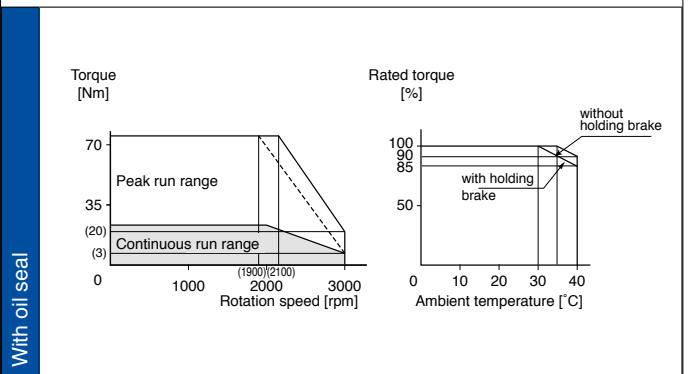

MDME754G1□

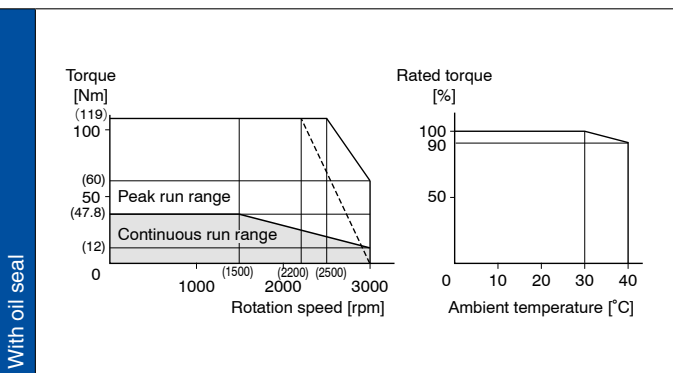

MDMEC14G1□

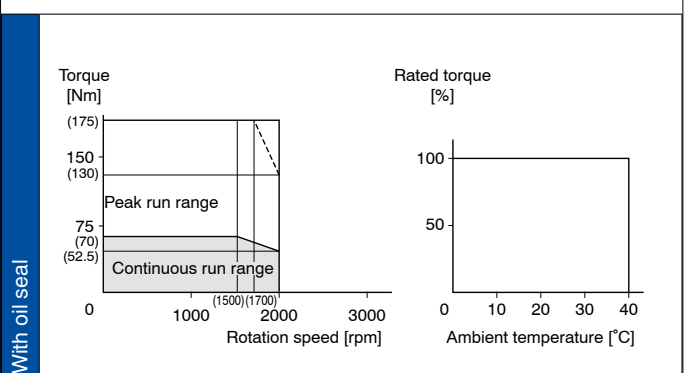

□ = Motor type, please refer to page 10.

Torque characteristics

MDMEC54G1□

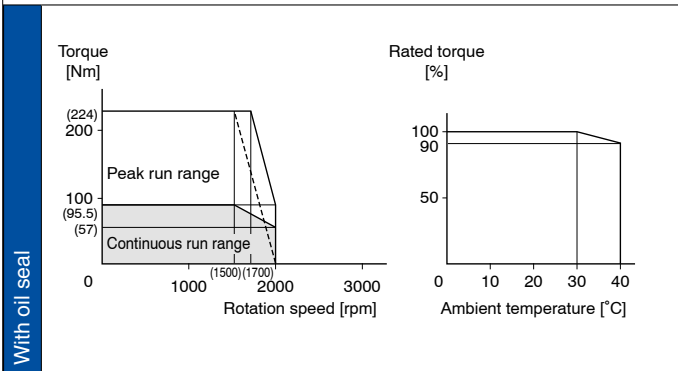

MHMD022G1□

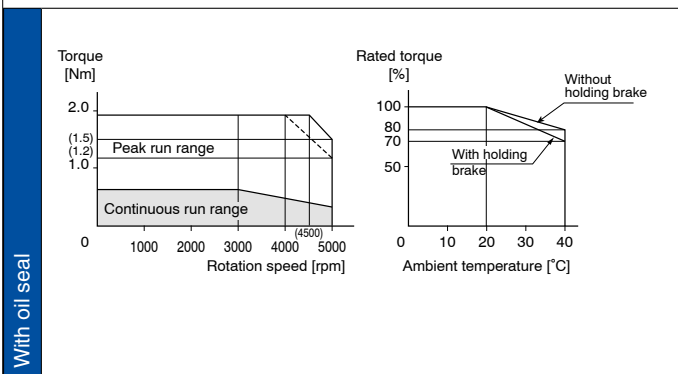

MHMD042G1□

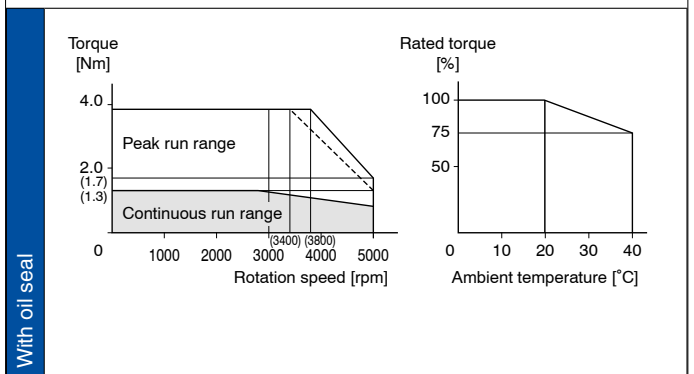

MHMD082G1□

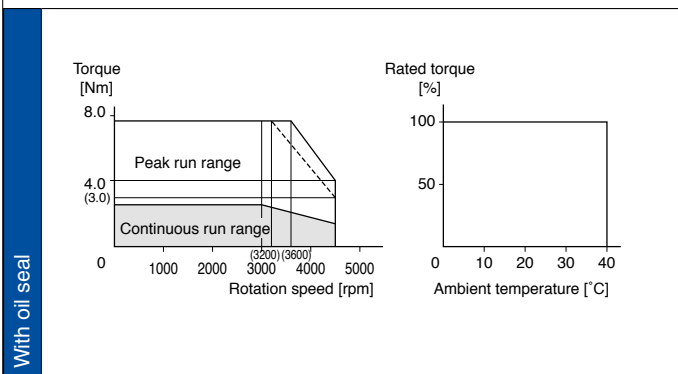

□ = Motor type, please refer to page 10.

MHME104G1□

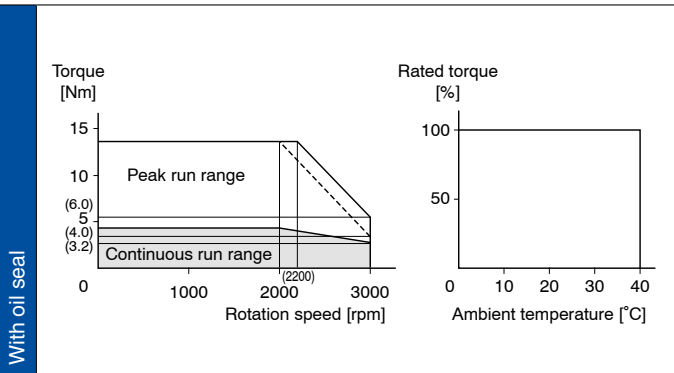

MHME154G1□

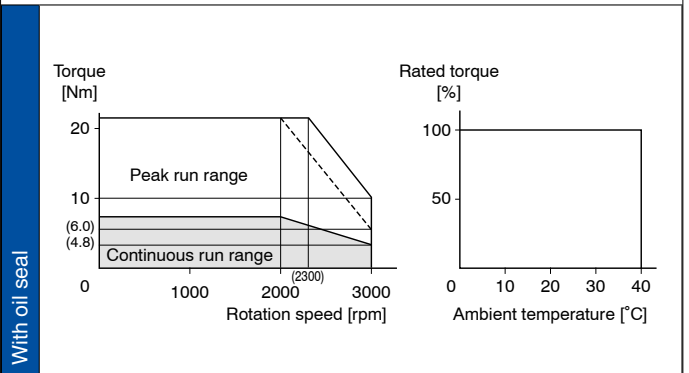

MHME204G1□

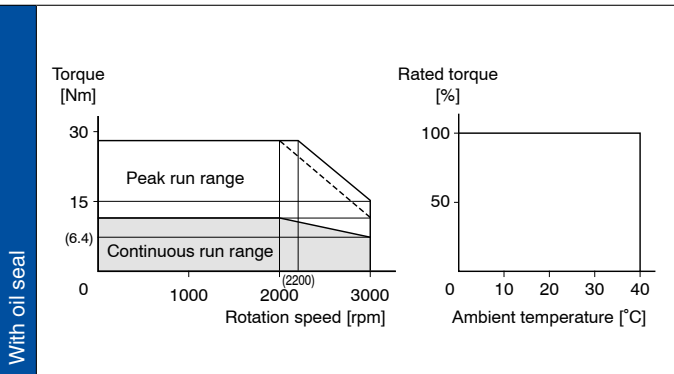

MHME304G1□

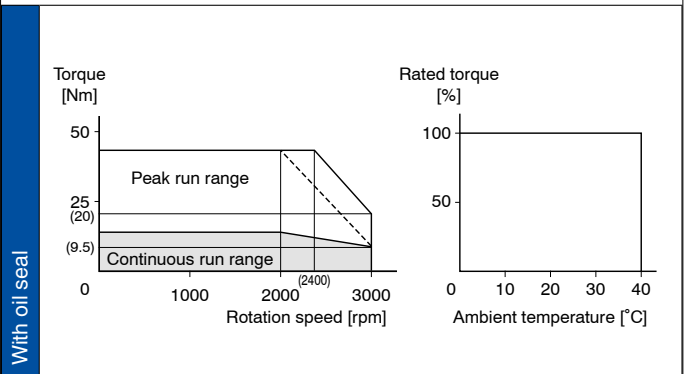

MHME404G1□

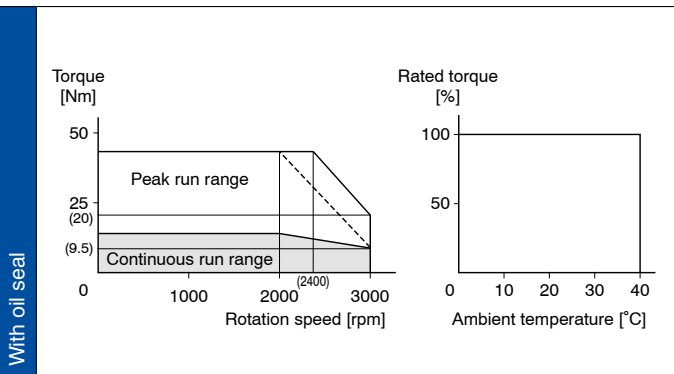

MHME504G1□

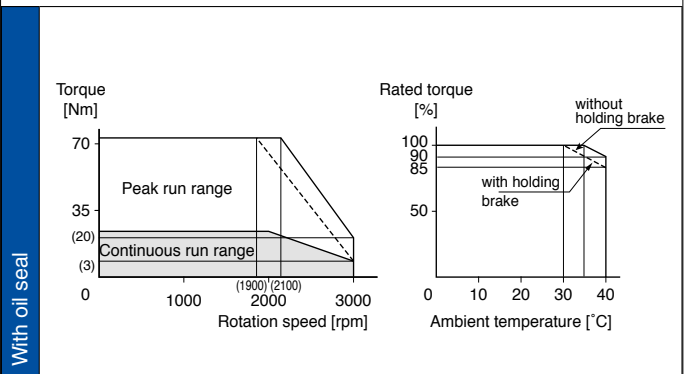

MHME754G1□

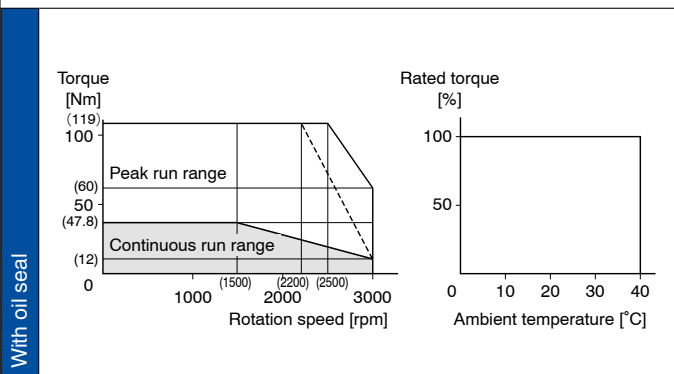

□ = Motor type, please refer to page 10.

MINAS A5 motor dimensions

50W–100W

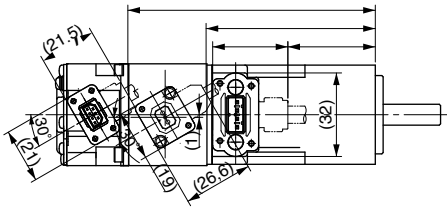

200W–750W

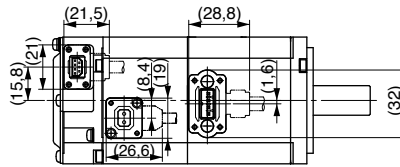

50W–750W

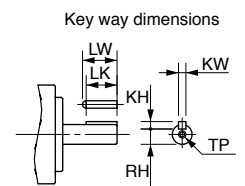
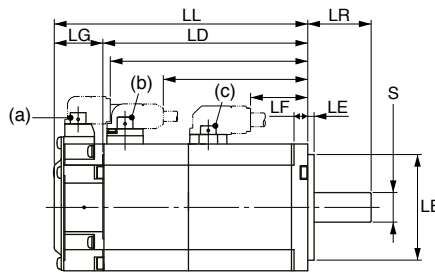
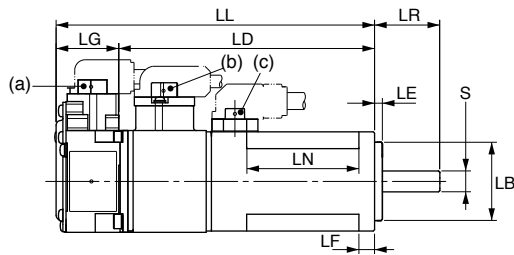
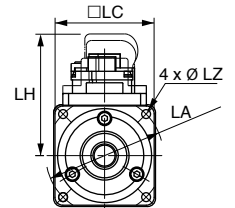

- a) Encoder connector
- b) Brake connector
- c) Motor connector

MSME (low inertia) 50–750W 200V AC

Rated power	W	50		100		200		400		750		
Motor	Type	MSME5AZG1□		MSME012G1□		MSME022G1□		MSME042G1□		MSME082G1□		
Encoder	20-bit incremental encoder resolution: 1048576ppr											
Motor with/without holding brake		Without	With	Without	With	Without	With	Without	With	Without	With	
LL	mm	72	102	92	122	79.5	116	99	135.5	112	148.2	
LR	mm	25				30				35		
S	mm	Ø 8 h6				Ø 11 h6		Ø 14 h6		Ø 19 h6		
LA	mm	Ø 45 ±0.2				Ø 70 ±0.2				Ø 90 ±0.2		
LB	mm	Ø 30 h7				Ø 50 h7				Ø 70 h7		
LC	mm	38				60				80		
LD	mm	48	78	68	98	56.5	93	76	112.5	86.2	122.2	
LE	mm	3				3				3		
LF	mm	6				6.5				8		
LG	mm	24				23				26		
LH	mm	(46.6)				(52.5)				(61.6)		
LN	mm	43				-				-		
LZ	mm	4 x Ø 3.4				4 x Ø 3.4		4 x Ø 4.5		4 x Ø 6		
Key way	LW	mm	14				20		25		25	
	LK	mm	12.5				18		22.5		22	
	KW	mm	3 h9				4 h9		5 h9		6 h9	
	KH	mm	3				4		5		6	
	RH	mm	6.2				8.5		11		15.5	
TP	mm	M3, depth 6				M4, depth 8		M5, depth 8		M5, depth 10		
Weight	kg	0.32	0.53	0.47	0.68	0.82	1.30	1.2	1.7	2.3	3.1	

□ = Motor type, please refer to page 10.

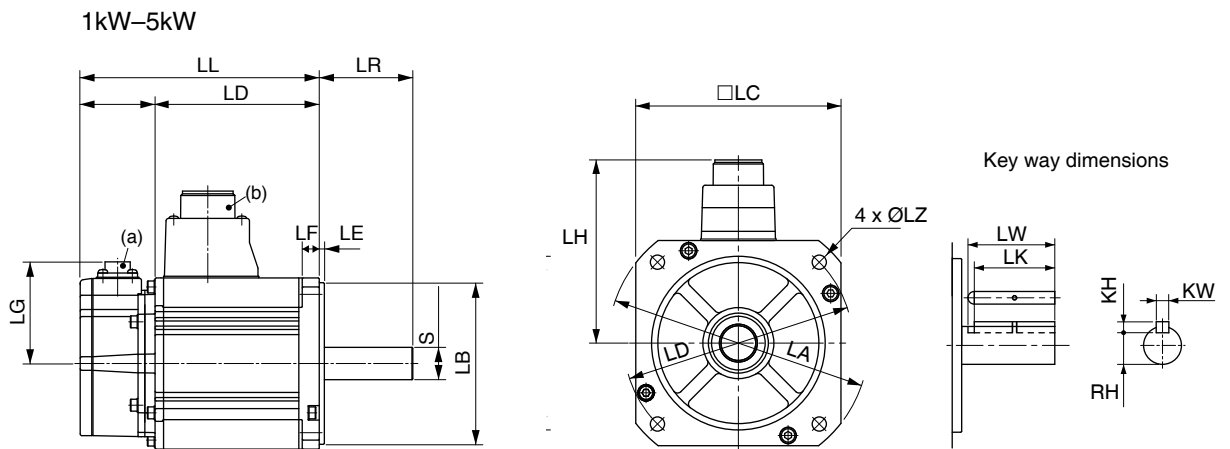

- a) Encoder connector
- b) Motor connector

MSME (low inertia) 1kW–1.5kW 200V AC, 1kW–5kW 400V AC									
Rated power		kW	1.0	1.5	2.0	3.0	4.0	5.0	
Motor	200V AC	Type	MSME102G1□	MSME152G1□	-	-	-	-	
	400V AC		MSME104G1□	MSME154G1□	MSME204G1□	MSME304G1□	MSME404G1□	MSME504G1□	
LL	Without holding brake	mm	141	159.5	178.5	190	208	243	
	With holding brake	mm	168	186.5	205.5	215	233	268	
LR		mm	55			55	65		
S		mm	∅ 19 h6			∅ 22 h6	∅ 24 h6		
LA		mm	∅ 135			∅ 162	∅ 165		
LB		mm	∅ 95 h7			∅ 110 h7			
LC		mm	100			120	130		
LD		mm	∅ 115			∅ 145			
LE		mm	3				6		
LF		mm	10			12	12		
LG		mm	(60)			(60)			
LH		mm	(101)			(113)	(118)		
LZ		mm	4 x ∅ 9						
Key way	LW	mm	45				55		
	LK	mm	42			41	51		
	KW	mm	6 h9				8 h9		
	KH	mm	6				7		
	RH	mm	15.5			18	20		
Weight	Without holding brake	kg	3.5	4.4	5.3	8.3	11	14	
	With holding brake	kg	4.5	5.4	6.3	9.4	12.6	16	

□ = Motor type, please refer to page 10.

MINAS A5 motor dimensions

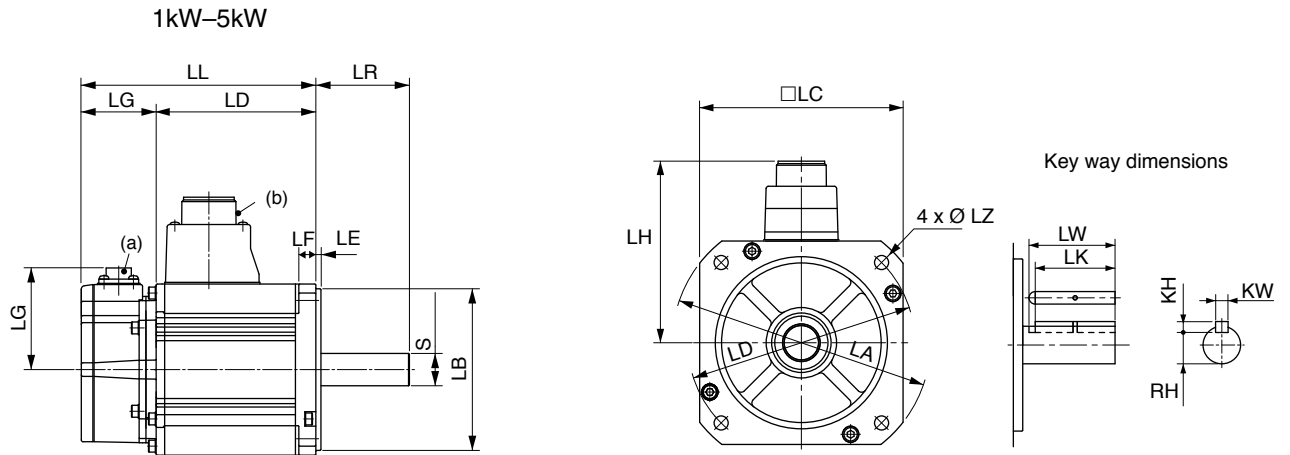

- a) Encoder connector
- b) Motor connector

MDME (medium inertia) 1kW–1.5kW 200V AC, 2–5kW 400V AC								
Rated power		kW	1.0	1.5	2.0	3.0	4.0	5.0
Motor	200V AC	Type	MDME102G1□	MDME152G1□	–	–	–	–
	400V AC		–	–	MDME204G1□	MDME304G1□	MDME404G1□	MDME504G1□
LL	Without holding brake	mm	138	155.5	173	208	177	196
	With holding brake	mm	163	180.5	198	233	202	221
LR		mm	55		55	65	70	
S		mm	Ø 22 h6			Ø 24 h6	Ø 35 h6	
LA		mm	Ø 165				Ø 233	
LB		mm	Ø 110 h7				Ø 114.3 h7	
LC		mm	130				176	
LD		mm	Ø 145				Ø 200	
LE		mm	6				3.2	
LF		mm	12				18	
LG		mm					(84)	
LH		mm	(116)		(118)		(140)	
LZ		mm	4 x Ø 9				4 x Ø 13.5	
Key way	LW	mm	45				55	
	LK	mm	41		51		50	
	KW	mm	8 h9				10 h9	
	KH	mm	7				8	
	RH	mm	18		20		30	
Weight	Without holding brake	kg	5.2	6.7	8.0	11.0	15.6	18.6
	With holding brake	kg	6.7	8.2	9.5	12.6	18.7	21.8

□ = Motor type, please refer to page 10.

7.5kW–15kW

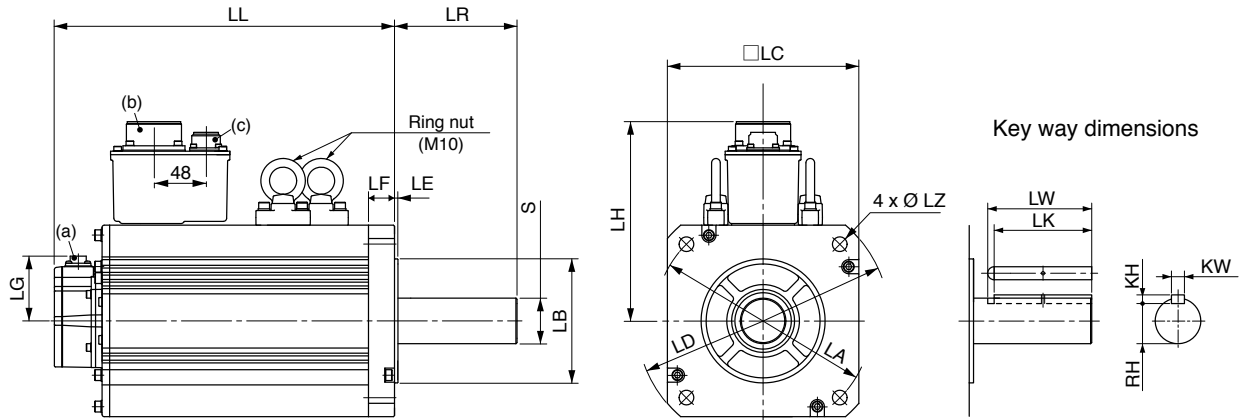

- a) Encoder connector
- b) Brake connector
- c) Motor connector

MDME (medium inertia) 7.5kW–15kW 400V AC					
Rated power		kW	7.5	11	15
Motor	400V AC	Type	MDME754G1□	MDMEC14G1□	MDMEC54G1□
LL	Without holding brake	mm	312	316	384
	With holding brake	mm	337	364	432
LR		mm	113	116	
S		mm	∅ 42 h6	∅ 55 h6	
LA		mm	∅ 233	∅ 268	
LB		mm	∅ 114.3 h7	∅ 200 h7	
LC		mm	176	220	
LD		mm	∅ 200	∅ 235	
LE		mm	3.2	4	
LF		mm	24	32	
LG		mm	(60)		
LH		mm	(184)	(205)	
LZ		mm	4 x ∅ 13.5		
Key way	LW	mm	96	98	
	LK	mm	90		
	KW	mm	12 h9	16 h9	
	KH	mm	8	10	
	RH	mm	37	49	
Weight	Without holding brake	kg	36.4	52.7	70.2
	With holding brake	kg	40.4	58.9	76.3

□ = Motor type, please refer to page 10.

MINAS A5 motor dimensions

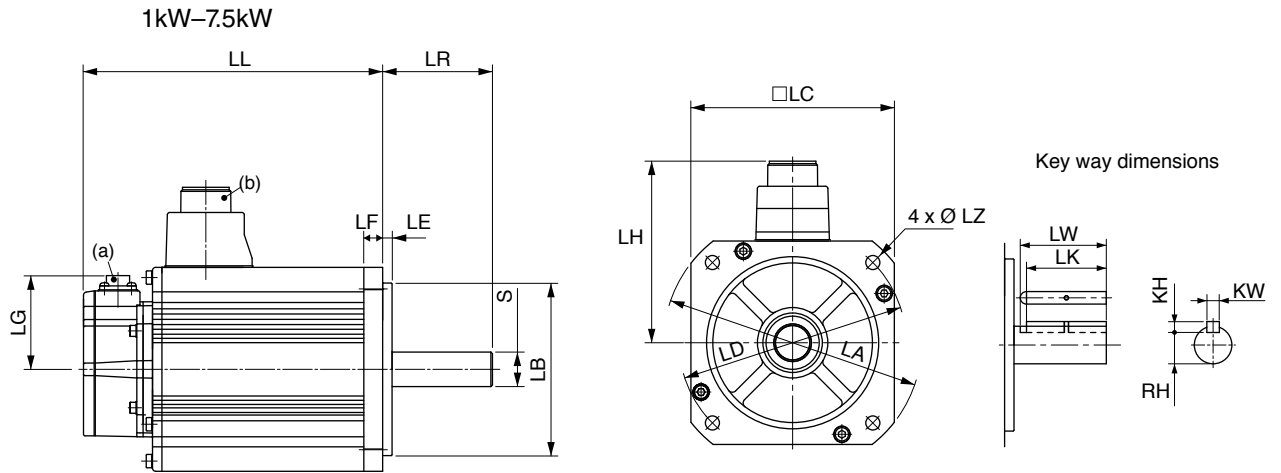

- a) Encoder connector
- b) Motor connector

MHME (high inertia) 1kW–7.5kW 400VAC										
Rated power		kW	1.0	1.5	2.0	3.0	4.0	5.0	7.5	
Motor	400V AC	Type	MHME104G1□	MHME154G1□	MH-ME204G1□	MHME304G1□	MH-ME404G1□	MH-ME504G1□	MH-ME754G1□	
LL	Without holding brake	mm	173	190.5	177	196	209.5	238.5	357	
	With holding brake	mm	198	215.5	202	221	234.5	263.5	382	
LR		mm	70			80			113	
S		mm	∅ 22 h6			∅ 35 h6			∅ 42 h6	
LA		mm	∅ 165			∅ 233				
LB		mm	∅ 110 h7			∅ 114.3 h7				
LC		mm	130			176				
LD		mm	∅ 145			∅ 200				
LE		mm	6			3.2				
LF		mm	12			18			24	
LG		mm	(60)							
LH		mm	(116)			(140)			(184)	
LZ		mm	4 x ∅ 9			4 x ∅ 13.5				
Key way	LW	mm	45			55			96	
	LK	mm	41			50			90	
	KW	mm	8 h9			10 h9			12 h9	
	KH	mm	7			8				
	RH	mm	18			30			37	
Weight	Without holding brake	kg	6.7	8.6	12.2	16	18.6	23	42.3	
	With holding brake	kg	8.1	10.1	15.5	19.2	21.8	26.2	46.2	

□ = Motor type, please refer to page 10.

MINAS LIQI

MINAS LIQI, the simple and cost-effective servo drive solution from Panasonic. Especially for dynamic applications MINAS LIQI offers many advantages as far as reliability, speed, and precision is concerned compared to stepping motors, asynchronous motors or pneumatic solutions. As for the MINAS A5 series, the PANATERM software and the MINAS SELECTION TOOL assist users in setting up and configuring the MINAS LIQI series. The series is optimally suited for the processing industries involving food, packaging, printing, metals, and plastics.



Features

- Incremental encoder: 2500 pulses per revolution
- Response frequency: 1kHz bandwidth (velocity response)
- PANATERM: Free software for configuration and motion simulation via USB port
- Real-time autotuning function during operation
- Damping (1-200Hz) and notch filters (50-5000Hz)
- Rotary switch (RSW): to set the stiffness manually

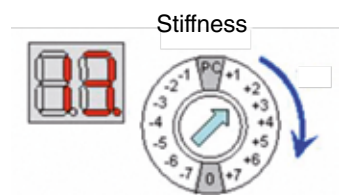

Driver (50W–1000V AC 1-phase)								
Driver	MINAS LIQI	Type	MBDJT2207			MBDJT2210	MCDJT3220	
	Frame	mm	B (D: 55.5 x H: 150 x W: 150)				C (D: 65.5 x H: 150 x W: 190)	
Rated power		W	50	100	200	400	750	1000
Motor (MSMD***J1* low inertia)								
Motor	Type	MSMD5AZJ1□	MSMD012J1□	MSMD022J1□	MSMD042J1□	MSMD082J1□	MSMD102J1□	
Nominal torque (peak torque)	Nm	0.16 (0.48)	0.32 (0.95)	0.64 (1.91)	1.3 (3.8)	2.4 (7.1)	3.2 (9.5)	
Rated rotational speed (max. rotational speed)	rpm	3000 (5000)				3000 (4500)	3000 (4000)	
Inertia (with holding brake)	$\times 10^{-4} \text{ kg} \cdot \text{m}^2$	0.025 (0.027)	0.051 (0.054)	0.14 (0.16)	0.26 (0.28)	0.87 (0.97)	1.16 (1.26)	
Encoder	2500ppr, incremental, resolution: 10000							
Degree of protection	IP65 (excluding shaft feedthrough and connectors)							

□ = Motor type

Ⓣ = With holding brake

Ⓢ = Without holding brake

MINAS LIQI driver functions

			Frame	MINAS LIQI
Supply voltage	Main circuit	200V	B	1-phase, 220–240V +5%, -10%, 50/60Hz
			C	1-phase, 220-240V (+5%, -10%), 50/60Hz
	Control circuit		B	1-phase, 220-240V (+5%, -10%), 50/60Hz
			C	1-phase, 220-240V (+5%, -10%), 50/60Hz
Operating conditions	Temperature		0–50°C, storage temperature: -20 to +65°C (max. temperature 80°C for 72 h)	
	Ambient humidity		Operation and storage: 20–85% RH (non-condensing)	
	Altitude		Max. 1000m above sea level	
	Vibration		Max. 5.88m/s ² , 10–60Hz (no continuous use at resonance frequency)	
Control method			IGBT sinusoidal PWM	
Encoder	Incremental (default)		2500ppr (resolution 10000, serial incremental encoder)	
Control signals	Input points		6 (multifunctional, customizable)	
	Output points		3 (multifunctional, customizable)	
Pulse signals	Input points		2 (photocoupler, line driver)	
	Output points		3 line driver (A, B and Z-phase) and 1 open collector (Z-phase)	
Interface	USB		Interface to PC, etc.	
Front panel			2 digital 7-segment LED displays, 2 digital rotary switches	
Braking resistor			External braking resistor only	
Dynamic brake			Built-in	
Control mode			Position control	

			MINAS LIQI	
Position control	Control input		1. Clear deviation counter 2. Command pulse inhibition 3. Damping control switching	
	Control output		Positioning complete etc.	
	Pulse input	Line driver		500kpps
		Signal format		Differential input/square-wave pulse
		Electronic gear		Scaling of pulse frequency from 1/1000 to 1000 times
		Smoothing filter		Primary delay filter or FIR filter, customizable
Damping control		Available		
Other features	Autotuning		Automatic adjustment of the servo controller's rigidity to the vibration behavior of the mechanical parts and changes to the load	
	Division of encoder feedback pulse		Any value up to the max. number of encoder pulses	
	Protective function	Error messages causing switch-off		Overvoltage, undervoltage, overspeed, overload, overheat, overcurrent and encoder error, etc.
		Error messages requiring acknowledgement		Excessive position deviation, command pulse division error, EEPROM error, etc.
	Alarm history		Can be logged for reference	

□ = Motor type, please refer to page 10.

MINAS LIQI torque characteristics

MSMD5AZJ1□

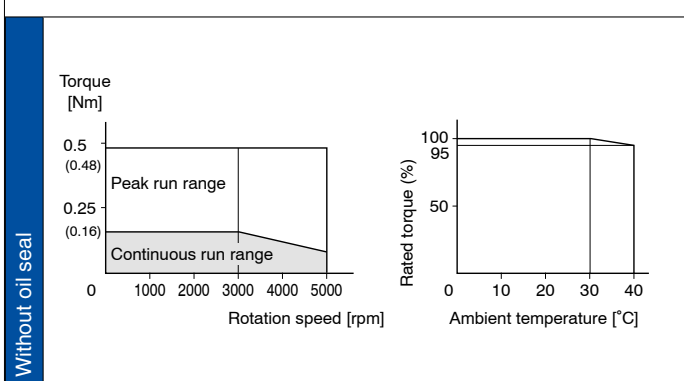

MSMD012J1□

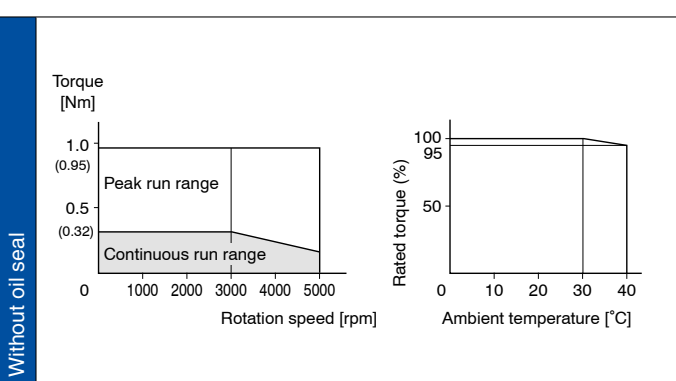

MSMD022J1□

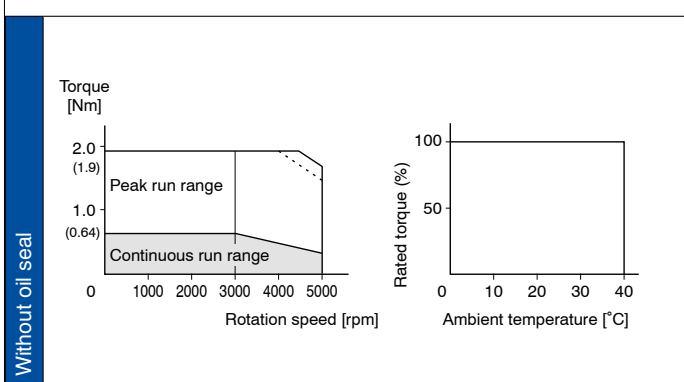

MSMD042J1□

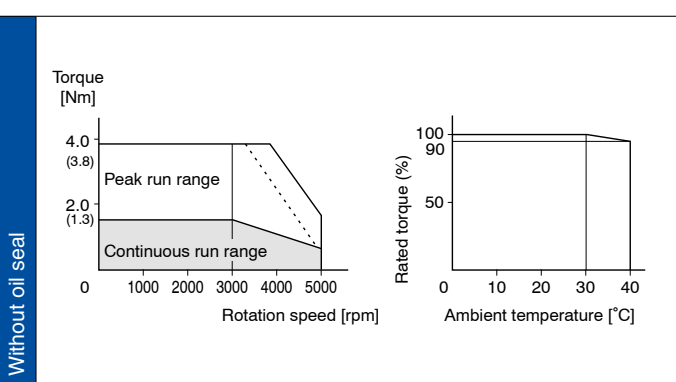

MSMD08J1□

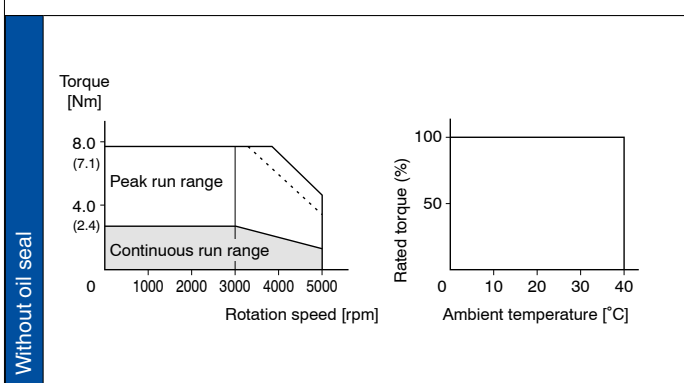

MSMD102J1□

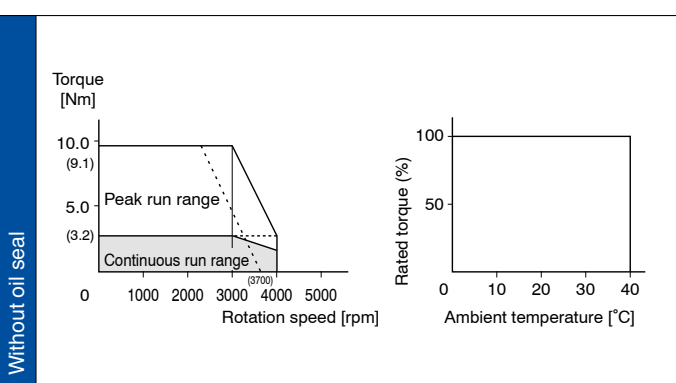

□ = Motor type, please refer to page 10.

MINAS LIQI motor dimensions

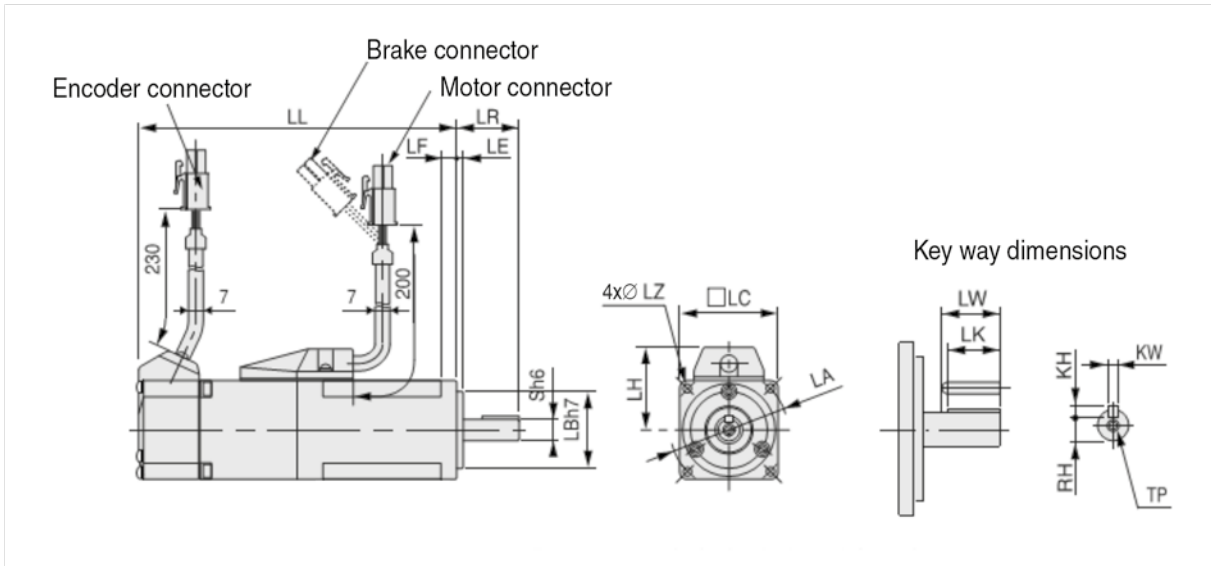

MINAS LIQI motors (low inertia)														
Motor	Type	MSMD5AZJ1□	MSMD012J1□	MSMD022J1□	MSMD042J1□	MSMD082J1□	MSMD102J1□	2500ppr, incremental, resolution: 10000						
Encoder														
Motor with/without holding brake		With-out	With	With-out	With	With-out	With	With-out	With	With-out	With	With-out	With	
LL	mm	72	102	92	122	79.5	116	99	135.5	112	149.2	127.2	164.2	
LR	mm	25				30				35				
S	mm	∅ 8 h6				∅ 11 h6		∅ 14 h6		∅ 19 h6				
LA	mm	∅ 45 ± 0.2				∅ 70 ± 0.2				∅ 90 ± 0.2				
LB	mm	∅ 30 h7				∅ 50 h7				∅ 70 h7				
LC	mm	38				60				80				
LE	mm	3												
LF	mm	6				6.5				8				
LZ	mm	4 x ∅ 3.4				4 x ∅ 4.5				4 x ∅ 6				
Key way	LW	mm	14				20		25		25			
	LK	mm	12.5				18		22.5		22			
	KW	mm	3 h9				4 h9		5 h9		6 h9			
	KH	mm	3				4		5		6			
	RH	mm	6.2				8.5		11		15.5			
	TP	mm	M3 depth 6				M4 depth 8		M5 depth 8		M5 depth 10			
Weight	kg	0.32	0.53	0.47	0.68	0.82	1.30	1.2	1.7	2.3	3.1	2.8	3.6	

□ = Motor type, please refer to page 10.

Motor cables (motor – servo driver)

All dimensions are in mm

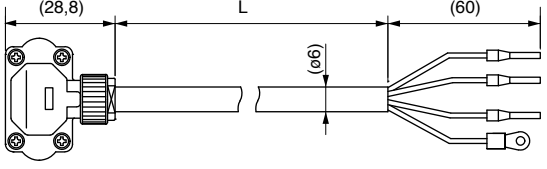
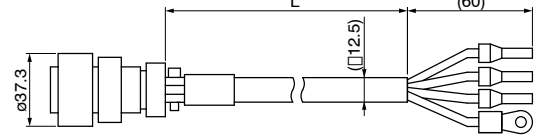
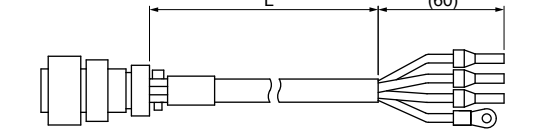
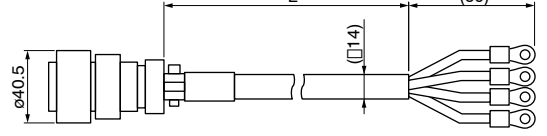
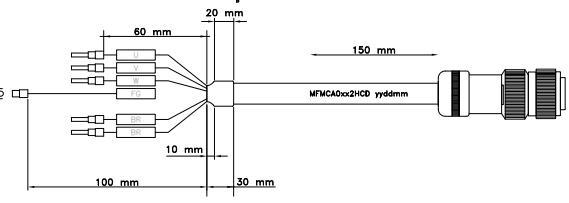
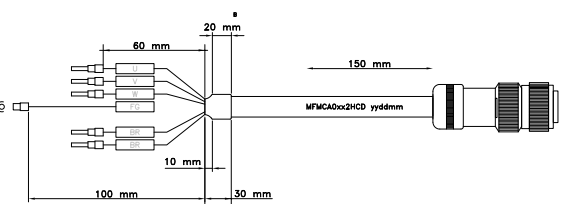
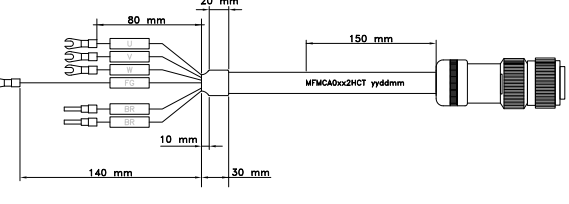
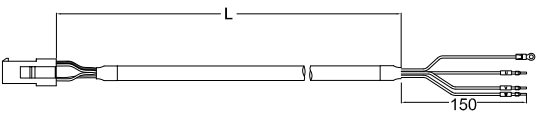
MSME motors 50–750W	MFMCA0□□0WJD	
MSME motors 1–2kW MDME motors 1–2kW MHME motors 1-1.5kW	MFMCD0□□2GCD	
MHME motors 2kW	MFMCE0□□2GCD	
MSME motors 3–5kW MDME motors 3–5kW MHME motors 3–5kW	MFMCA0□□2GCT	
MSME motors 1–2kW 200V with holding brake MDME motors 1–2kW 200V with holding brake	MFMCA0□□2HCD	
MSME motors 1–2kW 400V with holding brake MDME motors 1–2kW 400V with holding brake MHME motors 1–2kW 400V with holding brake	MFMCE0□□2HCD	
MSME motors 3–5kW with holding brake MDME motors 3–5kW with holding brake MHME motors 3–5kW with holding brake	MFMCA0□□2HCT	
MSMD motors 50–750W MHMD motors 200–750W MINAS LIQI motors 50W–1kW	MFMCA0□□0EEL	

□□ = Length

□0□ = 1m



□1□ = 10m

Brake cable (motor – servo driver)

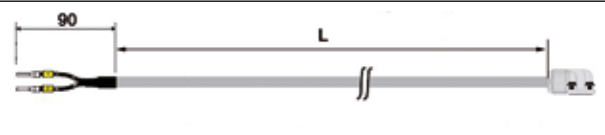
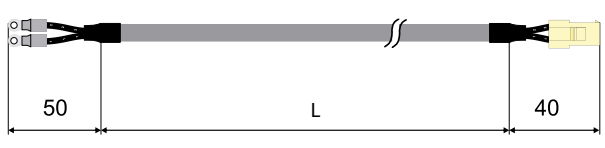
All dimensions are in mm

MSME motors 50–750W	MFMCB0□□0PJT	
MSMD motors 50–750W MHMD motors 200–750W MINAS LIQI motors 50W–1kW	MFMCB0□□0GET	

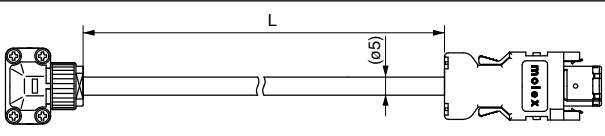
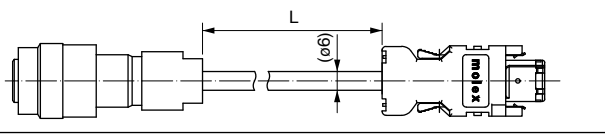
Encoder cable (motor – servo driver)

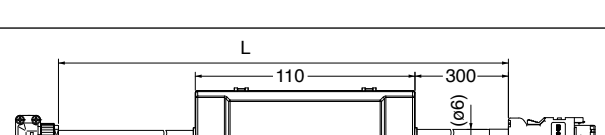
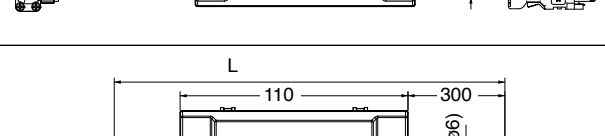
MSME motors 50–750W with 17/20-bit incremental encoder	MFECA0□□0WJD	
MSME, MDME, MHME motors 900W–15kW with 17/20-bit incremental encoder	MFECA0□□0GTD	
MINAS LIQI motors 50W–1kW MHMD, MSMD motors 200W–750W	MFECA0□□0EAM	
MSME motors 50–750W with 17-bit absolute encoder (battery box)	MFECA0□□0GJE	
MSME, MDME, MHME motors 900W–15kW with 17-bit absolute encoder (battery box)	MFECA0□□0GTE	

Control cable (PLC – MINAS LIQI driver)

Direct connection to FP series PLCs

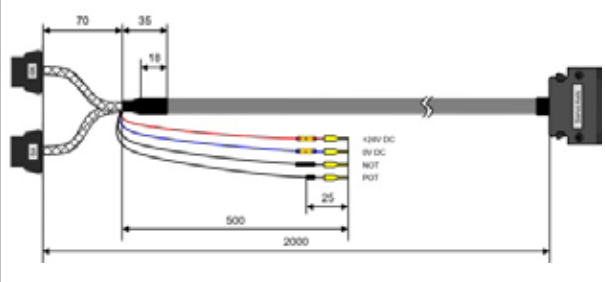
FPΣ (Sigma), FP0R	For 1 axis DV0P0800T01 (PNP types)	
-------------------	--	--

□□ = Length

01 = 1m

10 = 10m

Control cable (PLC – MINAS A5 driver)

All dimensions are in mm

Direct connection to FP series PLCs

<p>FPΣ (Sigma)</p>	<p>For 1 axis DVOP0980W-1 (NPN types) DVOP0982W-1 (PNP types)</p>	
<p>FPΣ (Sigma), FP0R</p>	<p>For 1 axis DV0P0988W-1 (PNP types) DV0P0989W-1 (NPN types)</p>	
<p>FPΣ (Sigma)</p>	<p>For 2 axes DVOP0981W-1 (NPN types) DVOP0983W-1 (PNP types)</p>	
<p>FPΣ (Sigma) Positioning unit FP2SH Positioning units</p>	<p>For 2 axes DVOP0985W1 (transistor) DVOP0986W1 (line driver)</p>	
<p>FP7 Positioning unit</p>	<p>For 2 axes DV0P0976W1 (line driver) DV0P0975W1 (transistor)</p>	

Product no.	Details/Comments/Dimensions			
Control cable				
DV0P4360	50W–15kW	50-pin type	I/O cable X4, loose wires, 2m	
DVOP4360P	50W–15kW	50-pin type	I/O cable X4, loose wires, 2m, position control	
DVOP4360V	50W–15kW	50-pin type	I/O cable X4, loose wires, 2m, velocity control	
DV0PM20024CAB020	50W–15kW	8-pin type	Communication cable X2, RS485, RS232, loose wires, 2m	
DV0PM20025CAB020	50W–15kW	8-pin type	Safety cable X3, loose wires, 2m	
DV0P0800T02	50W–15kW	26-pin type	I/O cable X4, loose wires, 2m	
Programming cable				
CABMINIUSB5D	50W–15kW	USB		
Connector set for servo driver				
DVOP4350	50W–15kW	50-pin type	I/Os, X4	
DVOP0770	50W–15kW	26-pin type	I/Os, X4	
DV0PM20026	50W–15kW	–	External encoder connector X5	
Connector set encoder, motor without holding brake				
DVOP4380	50W–1kW	–	MINAS LIQI/A4	
DV0PM20035	50W–750W	–	MINAS A5, IP67	
DV0PM20036	1kW–2kW	–	MINAS A5 MSME, MDME, MHME 1–1.5kW	
DV0PM20036A	1kW–2kW	–	Angled type; MINAS A5 MSME, MDME, MHME 1–1.5kW	
DV0PM20037	2kW–5kW	–	MINAS A5 MSME 3–5kW, MDME, MHME	
DV0PM20037A	2kW–5kW	–	Angled type; MINAS A5 MSME 3–5kW, MDME, MHME	
DV0PM20056	7.5kW–15kW	–	MINAS A5 MDME; MHME 7.5kW	
Connector set encoder, motor with holding brake				
DVOP4390	50W–1kW	–	MINAS LIQI/A4	
DV0PM20040	50W–750W	–	MINAS A5, IP67, holding brake connector kit	
DV0PM20038	1kW–2kW	–	MINAS A5 MSME, MDME, MHME 1–1.5kW	
DV0PM20038A	1kW–2kW	–	Angled type; MINAS A5 MSME, MDME, MHME 1–1.5kW	
DV0PM20039	2kW–5kW	–	MINAS A5 MSME 3–5kW, MDME, MHME	
DV0PM20039A	2kW–5kW	–	Angled type; MINAS A5 MSME 3–5kW, MDME, MHME	
DV0PM20057	7.5kW–15kW	–	MINAS A5 MDME; MHME 7.5kW	
EMC filter				
FN2080-6-06	50W–1000W	1-phase	250VAC, MINAS A5 50W–750W, MINAS LIQI 50W–1000W	
FS21238607	50W–750W	1-phase	Footprint filter, 250VAC	
FN2080-10-06	1kW–1.5kW	1-/3-phase	500V AC	
FN3268-7-44	1kW–3kW	3-phase	500V AC	
FN3268-16-44	4kW–5kW	3-phase	500V AC	
FN3258-30-33	15kW	3-phase	400V AC	
DV0P1460	50W–15kW	1-phase	Ferrite core, noise filter	
Braking resistors				
BWD250100	50W–100W	1-phase	100Ω, 100W, 600VAC	110 x 80 x 15 (L x W x D in mm)
BWD250072	200W–750W	1-phase	72Ω, 100W, 600VAC	
BWD500035	1kW–1.5kW	1-phase	35Ω, 200W, 600VAC	216 x 80 x 15 (L x W x D in mm)
BWD500150	1kW–1.5kW	3-phase	150Ω, 200W, 600VAC	
BWD500100	2kW	3-phase	100Ω, 200W, 600VAC	
BWD600047	3kW–5kW	3-phase	47Ω, 240W, 600VAC	
BWD600027	7.5kW	3-phase	27Ω, 240W, 600VAC	
BWD600027K02LV	11/15kW	3-phase	13,5Ω, 480W, 600VAC	

Braking resistor

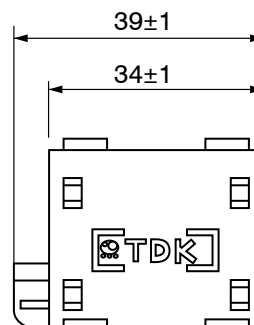

Ferrite core: DV0P1460

Weight: 62.8g

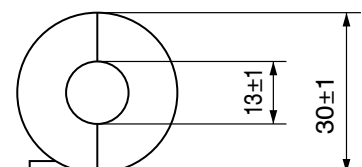

All dimensions are in mm.

EMC filter

200V AC:

FN2080-6-06 and FS21238607 for MINAS A5 50–750W and MINAS LIQI 50–1000W 1-phase drivers

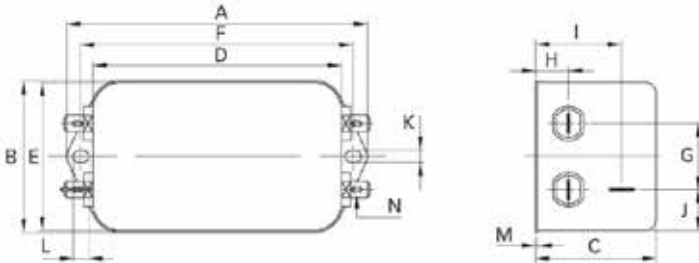

Dimensions (mm)	FN2080-6-06
A	113.5
B	57.5
C	45.4
D	94
E	56
F	103
G	25
H	12.4
I	32.4
J	15.5
K	4.4
L	6
M	0.9
N	6.3 x 0.8

All dimensions are in mm.

FN2080-6-06

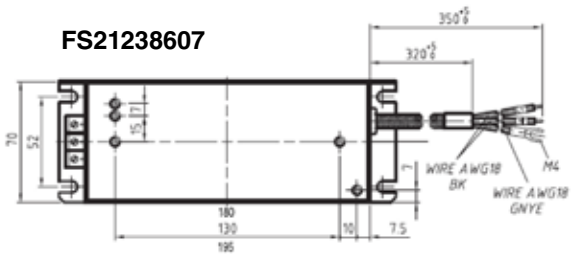

200V AC:

FN2080-10-06 for 1–1.5kW 1-phase driver

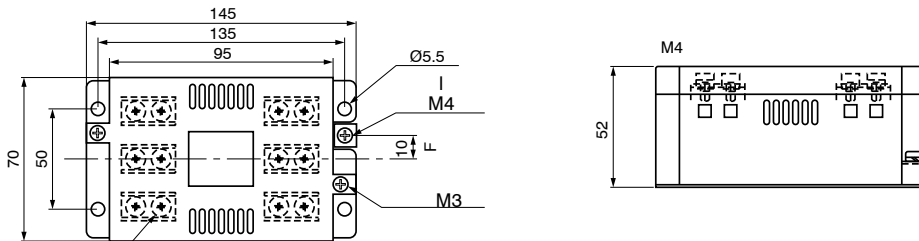

400V AC:

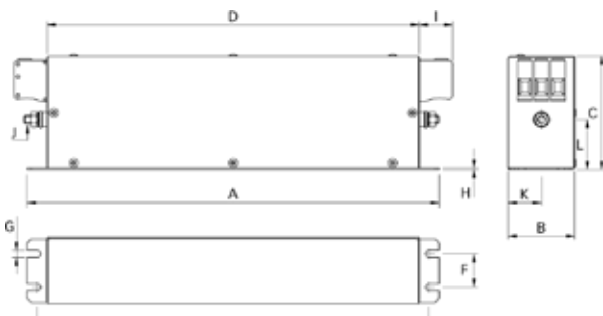

FN3268-7-44 for 1–3kW 3-phase driver, FN3268-16-44 for 4–5kW 3-phase driver







Dimensions (mm)	FN3268-7-44	FN3268-16-44
A	190	250
B	40	45
C	70	
D	160	220
E	180	235
F	20	25
G	4.5	5.4
H	1	
I	22	
J	M5	
K	20	22.5
L	29.5	



Programmable controllers

FP7	FP2SH
	
<p>Modular high-performance PLC</p> <ul style="list-style-type: none"> • Scan time of 11ns/step • Program capacity of 196k steps • Additional program capacity with SDHC memory card • Batteryless data backup • Ethernet 100BASE-TX/10BASE-TX • Expandable with up to 16 units for different applications 	<p>Modular high-performance PLC</p> <ul style="list-style-type: none"> • Scan time of 1ms for 20k steps • As a high-performance PLC with fast scan times ideally suited for electronic device manufacturing • High program capacity of 120k steps • 32k, 60k step type also available • Compatible with Small PC Cards, which serve as a program backup or extended memory for processing a large volume of data • 8192 I/O points max. (remote I/O system)

FP Σ (Sigma)	FP0R
	
<p>Very compact high-performance PLC reliably supports the control of higher speed equipment with more functions featured</p> <ul style="list-style-type: none"> • Excellent basic performance, including program capacity of 32k steps, operation speed of 0.32μs/step and 384 I/O points • Built-in 2-axis 100kHz pulse output capable of interpolation control • Positioning units capable of controlling network motion controllers • Can be equipped with up to 3 ports for program controlled communication without expansion unit • Compatible with PROFIBUS, DeviceNet, CANopen and other open field networks 	<p>Pocket-size ultracompact controller ideal for use in extremely narrow spaces</p> <ul style="list-style-type: none"> • Ultrahigh processing speed of 80ns/step within a range of 0 to 3000 steps • Program capacity from 16k–32k steps • 10–128 I/Os • Up to 24 thermocouple input points connectable for multipoint temperature control • Multiaxis control for up to 4 axes available without expansion units • Batteryless backup of all data

FP-X	FP-X0
	
<p>High-performance compact terminal-block type controller. Wide selection of add-on cassettes allows space saving use of the controller for a variety of purposes</p> <ul style="list-style-type: none"> • Up to three add-on cassettes can be attached to the top of the control unit. The unit is of the terminal block type, but is space saving and allows a variety of applications • Ethernet cassette available for data collection • Built-in 4-axis pulse output. Two axes for linear interpolation • Comment memory for simple maintenance work • USB port for direct connection to a PC 	<p>Entry level, compact, multifunctional PLC</p> <ul style="list-style-type: none"> • Max. 216 I/Os • Combined relay and transistor output (NPN) types • 2 analog input points and a clock/calendar function • Max. 2 serial ports: 1 x RS232C, 1 x RS485 • Program capacity: from 2.5k to 8k steps • Data registers: 2550 to 8192 words • Ethernet TCP/IP, Modbus RTU, PLC Link • Motion control functions

Jog positioning control (F171 instruction)

Motion can be started without a preset target value. When a stop signal is input, the target value is set, and the motion is slowed to a stop.

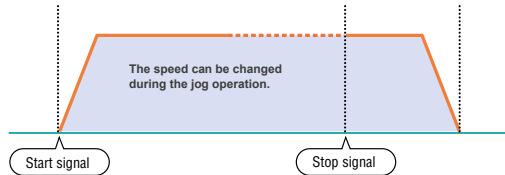

Useful for

- Labelers: Stopping the motion at a constant distance from the point where a label end detection signal is triggered
- Processing machines: Stopping the motion at a constant distance from the point where a processing object edge detection signal is triggered, and cut/drill the object

Individual settings for acceleration and deceleration (F171, F172, F174, and F175 instructions)

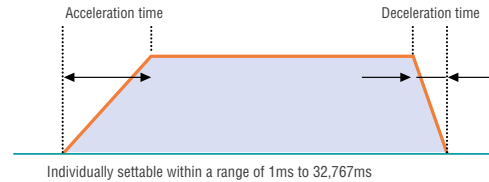

Useful for

- Labelers: Starting the operation at a relatively low acceleration to prevent tape from breaking
- Stopping the operation at high deceleration when detecting the label end to save the tape

Changing the speed (F171 and F172 instructions)

The target speed can be changed by an external signal input during the jog or trapezoidal control operation.

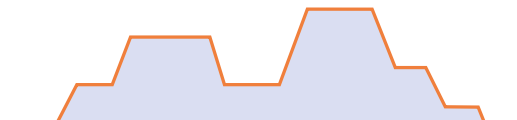

Useful for

- Speed synchronization of transfer/processing equipment

Measuring the pulse frequency (F178 instruction)

Pulses input in a specified period by a single instruction are counted, and the frequency is calculated.

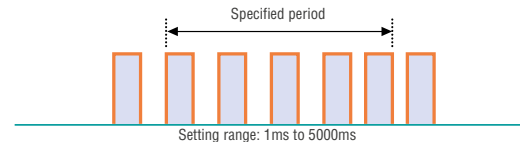

Useful for

- Detection of motor rotation speed for encoder feedback control

Built-in 4-axis pulse outputs (Transistor output type)

Multi-axis (4-axis) control is available without expansion units.

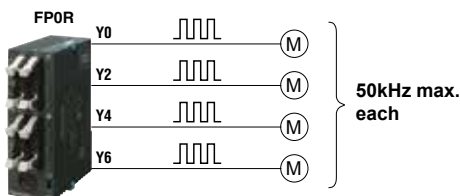

Two sets can simultaneously undergo two-axis linear interpolation (F175 instruction).

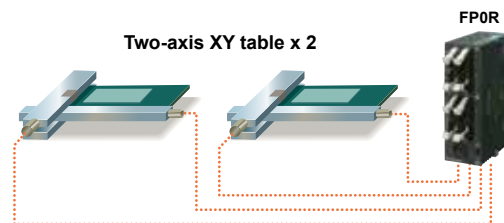

Simultaneously usable high speed counters (6 channels) and pulse outputs (4 channels)

The speed of conveyor 1, which is inverter-controlled, is measured based on the encoder pulse count, and pulses are output to the slave motor (for jog operation) according to the measured speed in order to synchronize the speed of conveyor 2.

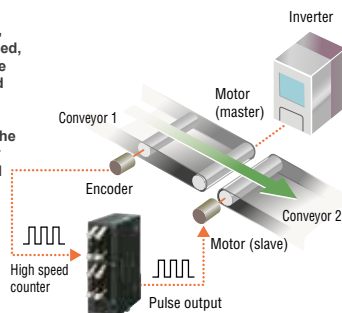

Built-in multipoint PWM outputs (4 channels)

A single FP0R unit can control the speeds of up to six DC motors/fan motors. It also can serve as an analog voltage output unit.

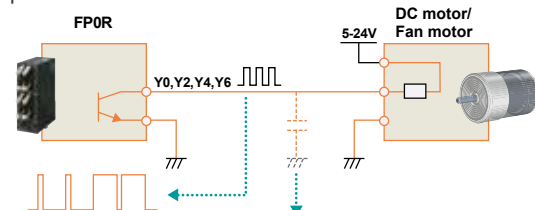

The speed can be controlled by changing the ON width of the PWM output within a range of 0.1% to 99.9%.

The unit can also serve as an analog voltage output unit (resolution: 1/1000) when a smoothing capacitor is inserted in the circuit.

PLC	Product number	Voltage	Output	Input points (counters)	Output points (axes)
	AFP0RC16□□	24V DC	Transistor NPN	8 (6)	8 (4)
	AFP0RC32□□			16 (6)	16 (4)
	AFP0RF32□□				

FPΣ (Sigma) positioning

Integrated linear and circular interpolation control

Interpolation functions enable simultaneous control of two axes. Applications that a compact PLC couldn't previously cope with are no longer a challenge. With linear interpolation, the PLC achieves a coordinated, linear movement of the two axes and controls the speed of each axis. Circular interpolation allows points to be smoothly traversed by arced paths for which the user specifies the orientation plane, the radius of curvature, motion path profile and direction of motion.

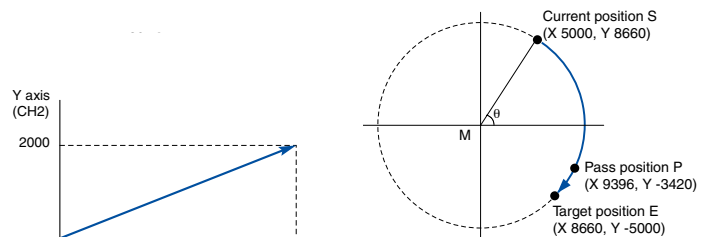

Simple and intuitive programming

For programming, a preset value table for starting speed, target speed, acceleration/deceleration time, and other factors will be used. Comes with dedicated instructions for each mode: trapezoidal control, home return, JOG operation, free table operation, linear interpolation and circular interpolation.

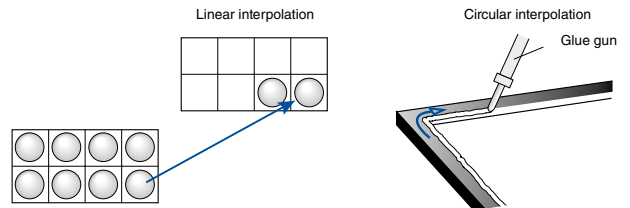

Clockwise/counter-clockwise output method

Reduce overall costs by designing systems that combine with servo motors and small stepping motors without support for Pulse and Sign method.

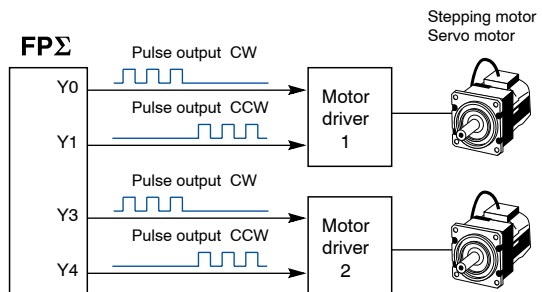

Smooth acceleration/deceleration

You can choose to set up to 60 steps of acceleration/deceleration. This allows for a smoother movement during long acceleration/ deceleration periods of stepping motors.

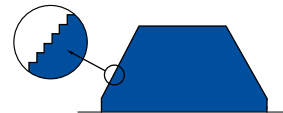

PLC	Product no.	Voltage	Output	Input points	Output points (axes)
	FPGC32T2HTM	24V DC	Transistor NPN	16	16 (2)
	FPGC28P2HTM	24V DC	Transistor PNP	16	12 (2)

Home position return

Home search automatically reverses the motor rotation when the positive or negative limit switch is reached and searches for the home position or near home position.

Pulse output up to 100kHz

A high output frequency and a rapid 0.02ms start allow for a precise and very fast positioning.

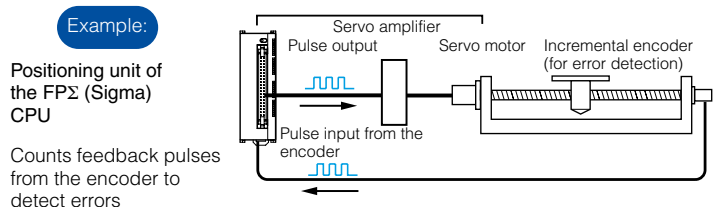

Positioning unit	Product no.	Output type	Output type
	FPGPP11	1-axis type	Transistor
	FPGPP21	2-axis type	
	FPGPP12	1-axis type	Line driver
	FPGPP22	2-axis type	

For low cost multi-axis position control

Built-in 4-axis pulse output (transistor output type)

The transistor output type C14 comes with 3-axis while C30/C38 and C60 come with 4-axis pulse output inside the control unit. The multi-axis control, which previously required a higher-level PLC or additional positioning unit, or two or more PLC units, can now be achieved with only one FP-X transistor output type unit in a small space at a low cost. In addition, as this type does not require a pulse I/O cassette as needed for a relay output type, other function expansion cassettes such as communication or analog input can be attached for more diversified applications.

Characteristic	Specification
Max. pulse output	C14: 100kHz (CH0,1), 20kHz (CH2) C30, C38, C60: 100kHz (CH0,1), 20kHz (CH2,3)
Pulse output methods	CW/CCW, Pulse + direction
Function	Trapezoidal control, multi-stage operation, jog operation, origin return, 2-axis linear interpolation

XY table + processing head

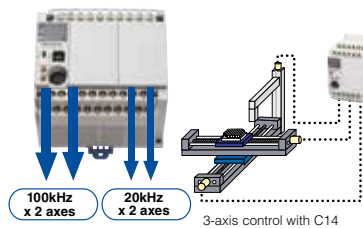

Semiconductor wafer takeout blade

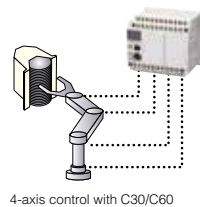

2-axis control with expansion cassettes for relay output types

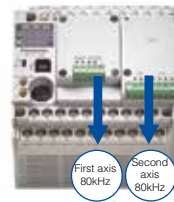

Pulse output up to 2-axis 80kHz is possible by loading 2 pulse I/O cassettes (AFPX-PLS). Also capable of performing 2-axis linear interpolation.

Note:
Pulse I/O cassette does not work with transistor CPU output type.

Linear interpolation simultaneously in 2 sets (transistor output type)

2-axis linear interpolation refers to moving a robot arm or equipment head diagonally on a straight line by simultaneously controlling 2 motor shafts. It is used for palletizing, component pick and place, XY table control, contour cutting of a PC board, etc. This makes the FP-X transistor output type the first compact pulse-output PLC capable of simultaneously controlling linear interpolation for 2 sets of axes. This unit dramatically expands the range of applications along with the added convenience of programming by using the linear interpolation command F175_PulseOutput_Linear.

Simultaneous control of 2 mechanisms

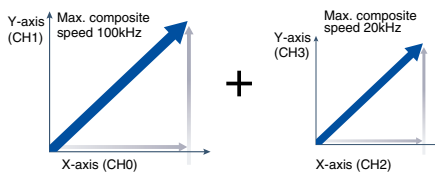

Controls two units of 2-axis XY table

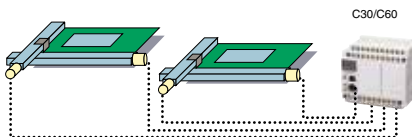

2-axis linear interpolation with relay output types

By adding 2 pulse I/O cassettes (AFPX-PLS), linear interpolation is possible at the maximum composite speed of 80kHz. The command used for this unit is F175_PulseOutput_Linear, the same as that for the transistor output types.

PLC	Product no.	Voltage	Output	Input points	Output points (axes)
	AFPXC14TDJ	24V DC	Transistor NPN	8	6 (3)
	AFPXC14TJ	100-240V AC			
	AFPXC14PDJ	24V DC	Transistor PNP		
	AFPXC14PJ	100-240V AC			
	AFPXC30TDJ	24V DC	Transistor NPN	16	14 (4)
	AFPXC30TJ	100-240V AC			
	AFPXC30PDJ	24V DC	Transistor PNP		
	AFPXC30PJ	100-240V AC			

PLC	Product no.	Voltage	Output	Input points	Output points (axes)
	AFPXC60TDJ	24V DC	Transistor NPN	32	28 (4)
	AFPXC60TJ	100-240V AC			
	AFPXC60PDJ	24V DC	Transistor PNP		
	AFPXC60PJ	100-240V AC			

FP7

Features

- Linear, circular, and spiral interpolation
- Max. speed 4Mpps (line driver), 500Kpps (transistor)
- Up to 600 points for each axis
- Integrated configurator software PM7 for parameter setting, JOG operation, home return, creation of data tables, etc.
- Electronic cam control and electronic gear



Product no.	Function	Output	Output points (axes)
AFP7PP02T	With interpolation	Open collector	2
AFP7PP04T			4
AFP7PP02L		Line driver	2
AFP7PP04L			4

FP2SH

Positioning units (interpolation type)

Features

- A pulse output of up to 4Mpps allows high-speed, high-precision positioning.
- 0.005ms high-speed drive reduces tact-time (start-up time is the time from reception of the CPU unit start-up command to release of the pulse output by the positioning unit).
- 4 axes per unit means versatility and saves space.
- The four types of S-curve acceleration/deceleration control allow for smooth startup and stoppage.
- Feedback pulse count function makes output pulse counting possible for encoders, etc.
- The pulse input function allows users to generate pulses manually to adjust machines, for example

PLC	Product no.	Program-capacity	Other features
	FP2C2LJ	32k steps	-
	FP2C2J	60k steps	
	FP2C2PJ	60k steps	IC memory card interface

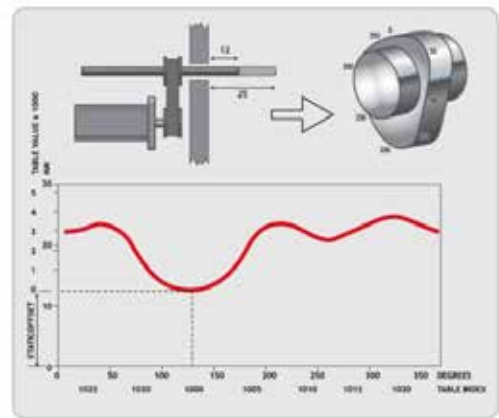

Functions

- Linear, circular, and spiral interpolation
- Synchronization operations
- E-point control
- P-point control
- JOG operation function
- Smooth acceleration/deceleration: Linear or in 4 curves sine curve, square curve, cycloid curve, and cubic curve

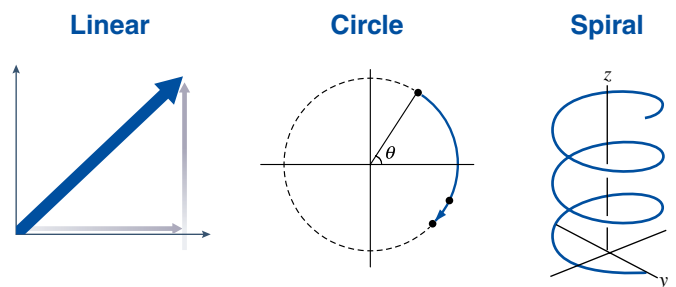

Positioning unit	Product no.	Functions	Output	Output points (axes)
	FP2-PP2T	With Interpolation	Open collector	2
	FP2-PP4T			4
	FP2-PP2L		Line driver	2
	FP2-PP4L			4
	FP2PP21	Without Interpolation	Open collector	2
	FP2PP41			4
	FP2PP22		Line driver	2
	FP2PP42			4

RTEX - the multiaxis Ethernet servo system

The RTEX positioning units support MINAS A5N network servo drives. A mutually optimized system consisting of PLC and servo driver greatly simplifies installation.

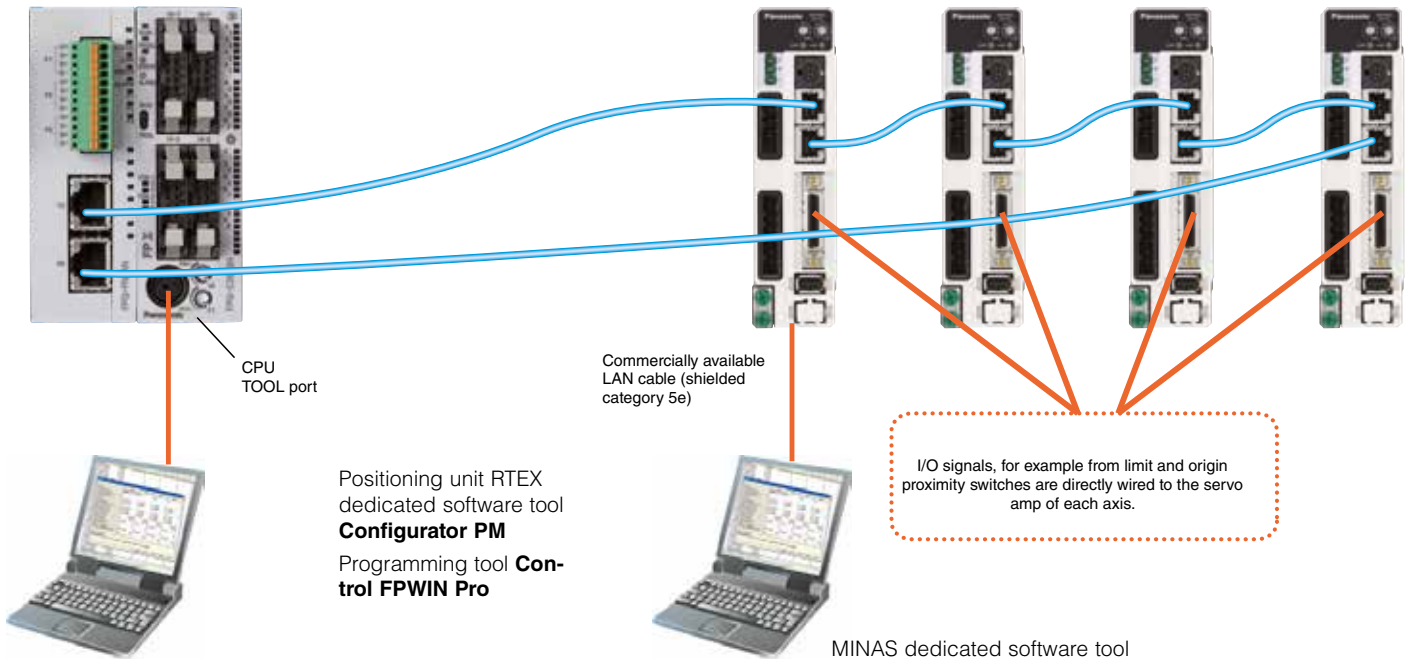

The main advantages of the RTEX positioning units:

- Unique: Allows easy control of network servos with an ultra-compact PLC.
- Allows highly accurate control of multi-axis positioning using high-speed 100Mbit/s communication.
- Minimization of wiring costs by using commercially available Ethernet cables. Position control of 2, 4, or 8 axes for servo drivers with Ethernet (RTEX) interface.
- Dedicated tool software Control Configurator PM supports operations from setup to startup and monitoring.
- Includes manual pulser input allowing support for precision teaching.

System configuration

Number of positioning units per RTEX unit

FPΣ (Sigma): 2 units (16 axes)

FP2SH: 32 units (256 axes)

Software Configurator PM for RTEX

The Configurator PM provides powerful yet simple full support ranging from configuration (axis and parameter settings, data table creation, JOG operation, home return, data monitor settings, etc.) to startup and operation monitoring. This saves time and makes commissioning considerably easier.

Product name	FPΣ (Sigma)	FP2SH	Number of axes	Output type	Product no.
Positioning units (interpolation type)	•		2	RTEX Ethernet	FPGPN2AN
		•			FP2SHPN2AN
	•		4		FPGPN4AN
		•			FP2SHPN4AN
	•		8		FPGPN8AN
		•			FP2SHPN8AN
Control Configurator PM	for all RTEX units				AFPS66510



Motion control libraries for Control FPWIN Pro (PLC)

The motion control library contains the most important function blocks, e.g. for relative or absolute positioning and for home returns with linear axes. Panasonic offers libraries for all motion control tasks.

1. CPU Motion Control Library: Position control with FP series control units (FP0R, FPΣ (Sigma), FP-X, FP7)
2. PP Motion Control Library: Positioning with PP motion control units (FPΣ (Sigma), FP2SH), FP7: Library is included in the PLC programming software Control FPWIN Pro.
3. RTEX Motion Control Library: Positioning with RTEX motion control units (FPΣ (Sigma), FP2SH)

Advantages of PLC programs using the Motion Control Library

- Free** – just download it from Panasonic's website
- Simple** – easy programming and installation
- Efficient** – ready-to-use function blocks, only set the parameters
- Consistent** – compliant with IEC 61131-3
- Universal** – hardware-independent (works for every Panasonic PLC)
- Flexible** – expandable for up to 256 axes
- Fast** – short and easy commissioning (ready-to-use example programs)



**Download the software free of charge from Panasonic's website:
Home → Downloads → SPS → FPWIN Pro → Library**

MC_CPU_Library Motion

POEs: MC_PulseOutput_Library

- MC_HomeReturn_WithNearHome (FB)
- MC_HomeReturn_WithoutNearHome (FB)
- MC_Jog (FB)
- MC_MoveAbsolute (FB)
- MC_MoveRelative (FB)
- MC_StopChannel (FB)
- MC_Initial_Configuration [VOID] (FUN)

RTEX Motion Control Library

POEs: RTEX_Library_v1.3

- RTEX_AMP_ReadParameter (FB)
- RTEX_AMP_Restart (FB)
- RTEX_AMP_WriteEEPROM (FB)
- RTEX_AMP_WriteParameter (FB)
- AxisInputError [BOOL] (FUN)
- AxisSlotInputError [BOOL] (FUN)
- CalculateIXIY [VOID] (FUN)

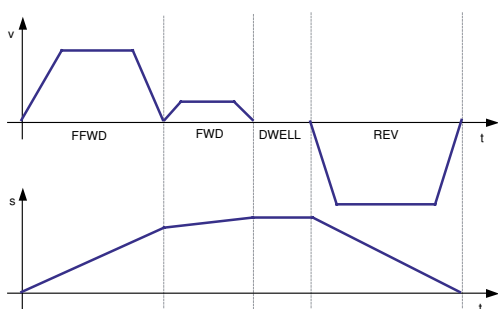
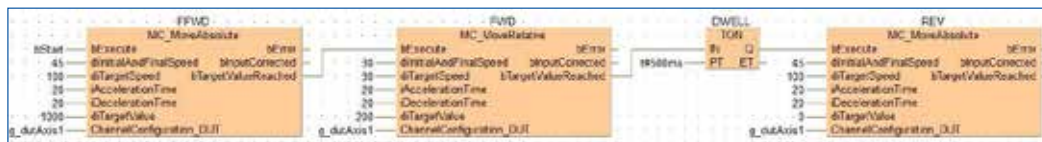

Time chart

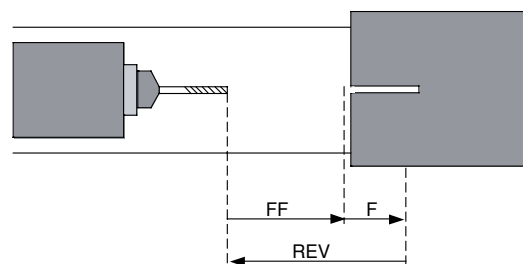

Drilling setup

Free of charge!

Direct access to servo drive parameters from the PLC

The libraries enable serial communication (RS232, RS485) between the FP series PLCs and the drivers of the MINAS A5 series.

The communication protocols for the drivers are also included in the libraries. The libraries allow full read and write access to the parameters. They also record the status and position data of the axes. All FP series PLCs come with an RS232 port (RS485 optional).

With RS232 connections, the first driver can be used as a gateway to downstream drivers so that all drivers can communicate with the PLC.

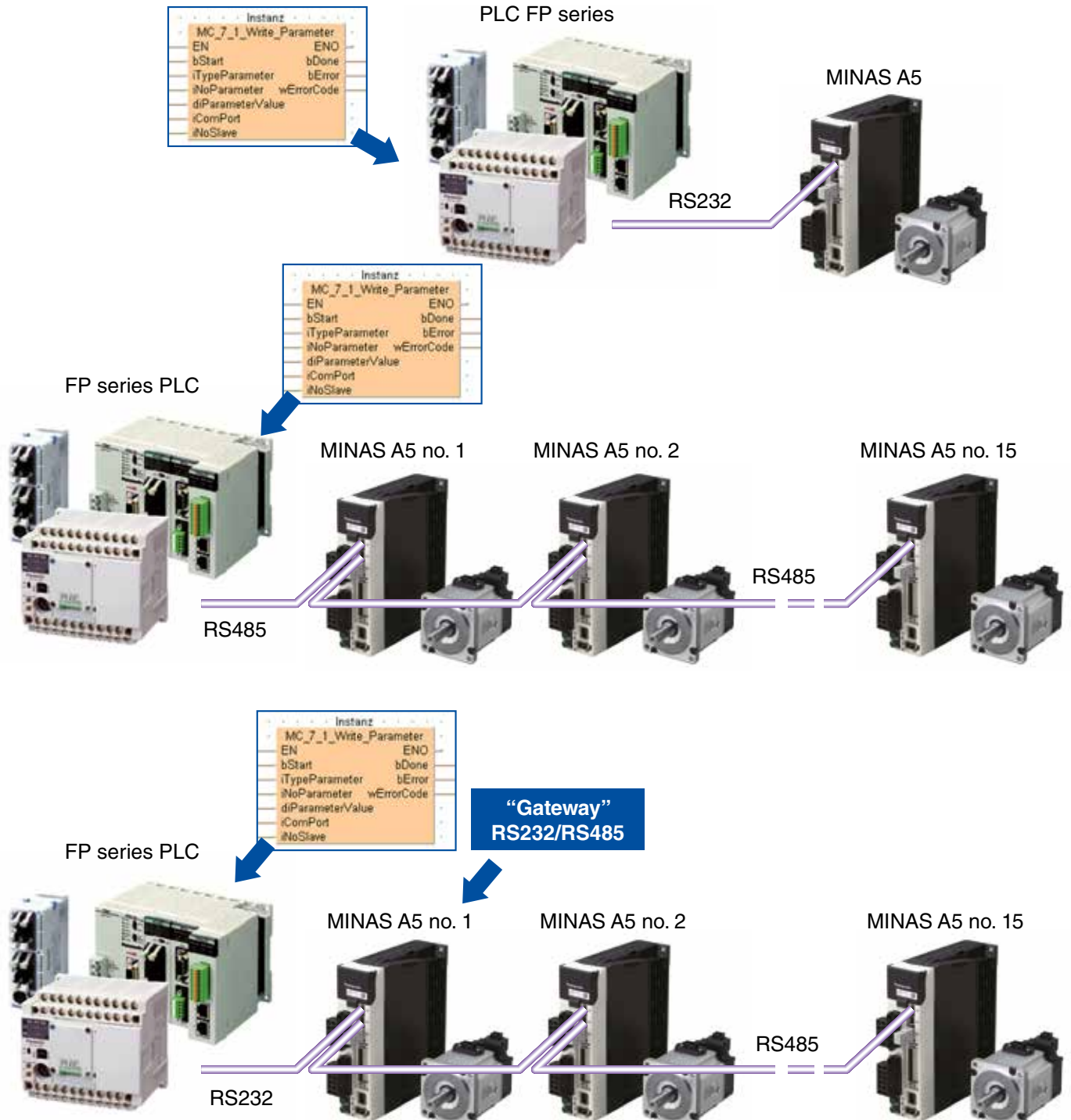

Download the software free of charge from Panasonic's website:
Home → Downloads → SPS → FPLIN Pro → Library

Software Configurator PM for RTEX

The Configurator PM offers multiple support from configuration (axis and parameter settings, data table creation, JOG operation, home return, data monitor settings, etc.) to startup and operation. This saves time and makes commissioning considerably easier.

Axis settings

Check the axes to be used. Select the number of axes to be used.



Grouping of axes for interpolation operations is carried out simply by dragging and dropping the relevant axes.

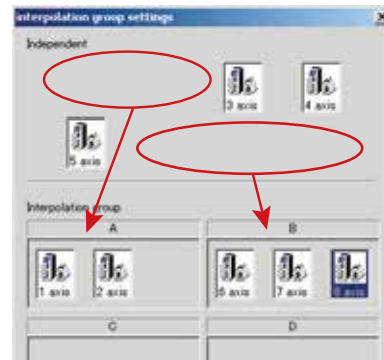

Parameter settings

The details of the settings can be displayed in a table. Details on how to create settings for each category are explained in the box below.

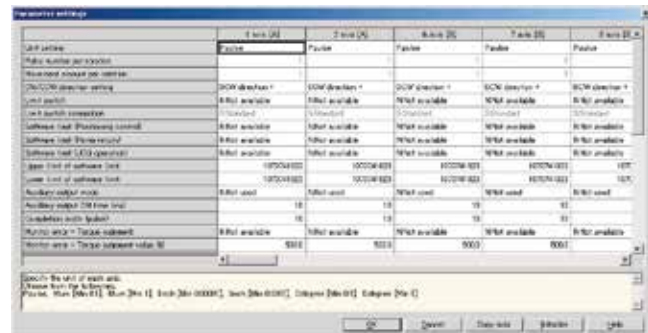

Parameters can be copied between axes. In instances where many settings are shared among the axes, this can reduce the number of repeat inputs.



Data table creation

Simple input as in Excel.

Each axis (or each interpolation axis group) has a separate sheet, and data tables for each axis are displayed in an easy-to-understand manner.

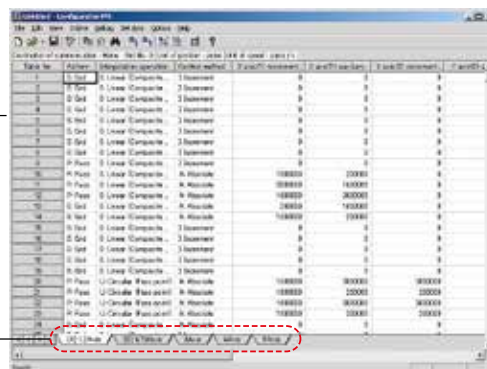

Data tables can be exported as text files in CSV format. This is effective when making printouts for document management.

You can copy parts of a CSV file to a data table using cut & paste.

Software Configurator PM for RTEX

Tool operations

- Each axis can be operated by test sequences independently of the operation modes (PROG and RUN) of the RTEX or FP control unit.
- JOG operation and teaching can be carried out easily to index positioning points. Test operation is possible without having to create a rudder program.

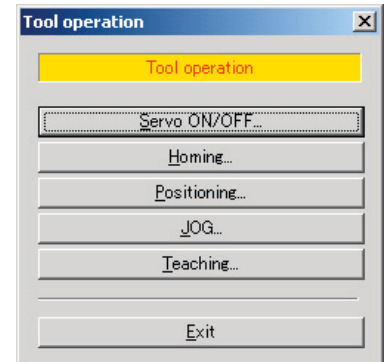

Data monitor

- Data table no. during operation
- Auxiliary output
- Current position, speed and vector
- Error code, warning code (errors and warnings can also be cleared)

Status monitor

- Connection status of each axis
- Model code of each motor amp and motor connected
- Servo lock status
- Near home input, limit input

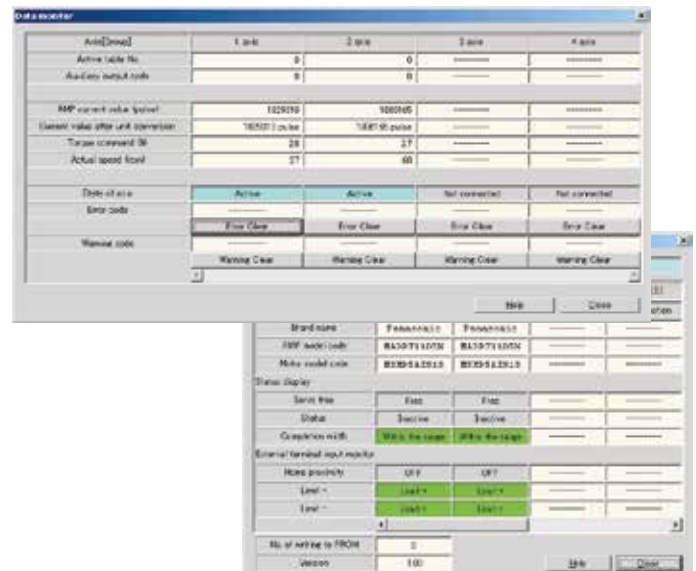

Configuring servo drivers

Free of charge!

Configuration software PANATERM for MINAS AC servo motors & drivers

PANATERM assists users in making parameter and control settings as well as creating and analyzing data tables during operation. The software can be installed on any commercially available personal computer. The connection to the MINAS series is established via the USB port.



Basic functions

- Parameter setup
- After a parameter has been defined on the screen, it will immediately be sent to the driver.
- Frequently used parameters can be listed separately in a second display.

Monitoring control conditions

- Monitor
- Settings: control mode, velocity, torque, error and warning
- Driver input signal
- Load conditions: Overview of command/feedback pulses, load ratio, regenerative resistive load ratio
- Alarm
- Display/delete number and contents of the current alarm and the last 14 error events

Setup

- Auto tuning
- Gain adjustment and inertia ratio measurement
- Line graph display
- The line graph diagram shows command and current velocity, torque, and the tracking error.
- Absolute encoder setup
- Clears absolute encoder at the origin
- Displays single turn/multi turn
- Displays absolute encoder status

Analysis of mechanical operation data (frequency analysis)

- Measures frequency characteristics of the machine; displays Bode diagram

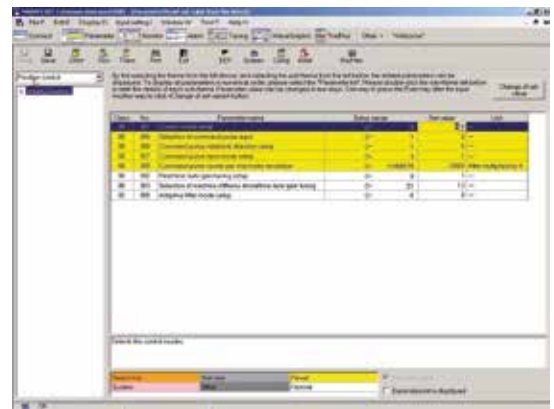

Parameters



Monitor

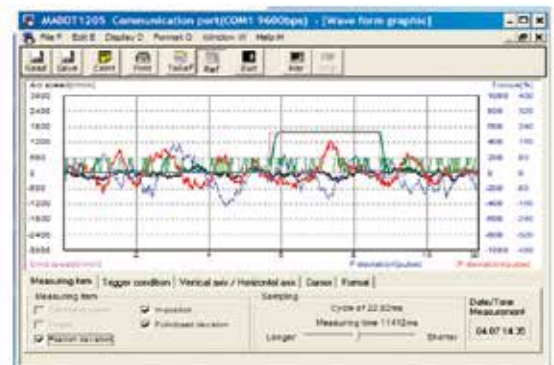

Line graph display

Download the software free of charge from Panasonic's website:
Home → Downloads → SPS → FPWIN Pro → Library

Free of charge!

Motor capacity selection software

M-SELECT software

M-SELECT is a software to help you select the correct motor capacity and servo driver from Panasonic's MINAS series. Find the optimal type of motor with regards to the mechanical layout and the dynamic requirements. It is a very valuable tool for mechanical engineering as it also provides CAD data in 2D and 3D. The software offers a complete analysis and detailed usage instructions for the MINAS A5 series in all sizes.

Figure 1



Figure 2



Figure 3



Figure 4

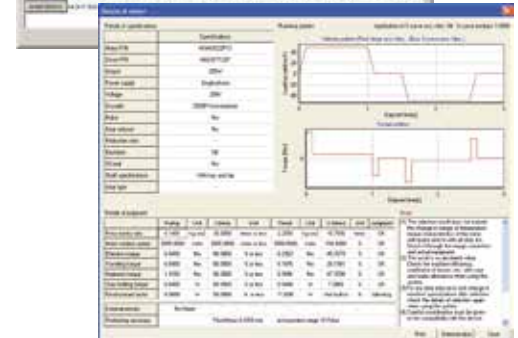

Selecting the motor capacity is done in four steps:

1. Select mechanical parts and input their parameters (figure 1)

The user can select parts from a database with all mechanical standard parts (gears, coupling, spindle axis, etc.).

2. Determine the motion profile (figure 2)

Speed, position, ramps, etc.

3. Select the correct motor series (figure 3)

1- or 3-phase, input voltage, torque, etc. The software calculates the parameters for the series selected and displays the different criteria with OK or NG (not good).

4. Check and print result (figure 4)

MINAS SELECTION TOOLS

This is an easy-to-use software to help you select the accessories. The software can be installed on any commercially available PC.

1. Enter motor data, encoder selection, and cable length

2. Click [Select_MINAS] to display all matching accessories

Drivers, filters, cables, etc.

3. You can even have the data sent to you or your customer by e-mail.

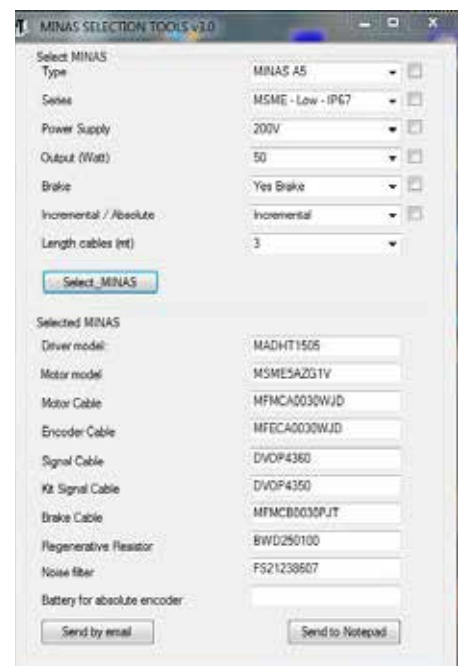

Download the software free of charge from Panasonic's website:
Home → Downloads → SPS → FPWIN Pro → Library

Memo

A large grid of 20 columns and 30 rows, intended for taking notes. The grid is composed of thin, light gray lines forming a series of small squares. The grid is empty and occupies the majority of the page area below the 'Memo' header.

Other Panasonic products

Panasonic Electric Works offers a wide product range from one source, from individual components to complete systems. Technology support for advice, design-in, installation and commissioning by our qualified application engineers round off the Panasonic service profile.



Human machine interfaces

Our compact size, bright and easy-to-read human machine interfaces can be used to visualize inspection results. Touch panels can even replace the standard keypad if you so desire.



UV curing systems

Aicure UJ30 is a LED curing system that quickly hardens UV-sensitive resins such as adhesives, ink and coatings. Its cutting edge LED technology is especially suited for precise, high-intensity curing.



ACD components

Components such as Eco-POWER METERS, timers/counters, temperature controllers, limit switches and fans round off our wide factory automation product range.

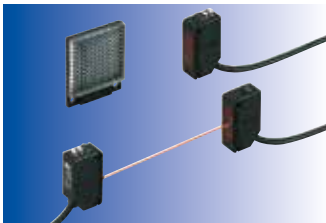

Sensors

As a pioneering manufacturer of sensors, Panasonic provides high performance sensors for a wide range of applications, facilitating factory automation in various types of production lines, such as those used for the manufacturing of semiconductors.



Laser Markers

Panasonic Laser Markers are ideal for non-contact, permanent labeling of most materials, e.g. metal, plastics, glass, paper, wood and leather. Several CO₂ laser marking systems and a unique FAYb fiber laser marker can be easily integrated into existing production systems for a great variety of marking tasks.



North America

Europe

Asia Pacific

China

Japan

Panasonic Electric Works

Please contact our Global Sales Companies in:

Europe		
▶ Headquarters	Panasonic Electric Works Europe AG	Robert-Koch-Straße 100, 85521 Ottobrunn, Tel. +49 89 45354-1000, Fax +49 89 45354-2111, www.panasonic-electric-works.com
▶ Austria	Panasonic Electric Works Austria GmbH	Josef Madersperger Str. 2, 2362 Biedermannsdorf, Tel. +43 (0) 2236-26846, Fax +43 (0) 2236-46133 www.panasonic-electric-works.at
	Panasonic Industrial Devices Materials Europe GmbH	Ennsbahnstraße 30, 4470 Enns, Tel. +43 (0) 7223 883, Fax +43 (0) 7223 88333, www.panasonic-electronic-materials.com
▶ Benelux	Panasonic Electric Works Sales Western Europe B.V.	De Rijn 4, (Postbus 211), 5684 PJ Best, (5680 AE Best), Netherlands, Tel. +31 (0) 499 372727, Fax +31 (0) 499 372185, www.panasonic-electric-works.nl
▶ Czech Republic	Panasonic Electric Works Europe AG, organizační složka	Administrative centre PLATINIUM, Veveří 3163/111, 616 00 Brno, Tel. +420 541 217 001, Fax +420 541 217 101, www.panasonic-electric-works.cz
▶ France	Panasonic Electric Works Sales Western Europe B.V.	Succursale française, 10, rue des petits ruisseaux, 91370 Verrières Le Buisson, Tél. +33 (0) 1 6013 5757, Fax +33 (0) 1 6013 5758, www.panasonic-electric-works.fr
▶ Germany	Panasonic Electric Works Europe AG	Robert-Koch-Straße 100, 85521 Ottobrunn, Tel. +49 89 45354-1000, Fax +49 89 45354-2111, www.panasonic-electric-works.de
▶ Hungary	Panasonic Electric Works Europe AG	Magyarországi Közvetlen Kereskedelmi Képviselet, 1117 Budapest, Neumann János u. 1., Tel. +43 2236 26846-25, Mobile: +36 20 264 9896, Fax +43 2236 46133, www.panasonic-electric-works.hu
▶ Ireland	Panasonic Electric Works UK Ltd.	Irish Branch Office, Dublin, Tel. +353 (0) 14600969, Fax +353 (0) 14601131, www.panasonic-electric-works.co.uk
▶ Italy	Panasonic Electric Works Italia srl	Via del Commercio 3-5 (Z.I. Ferlina), 37012 Bussolengo (VR), Tel. +39 0456752711, Fax +39 0456700444, www.panasonic-electric-works.it
▶ Nordic Countries	Panasonic Electric Works Europe AG Panasonic Eco Solutions Nordic AB	Filial Nordic, Knarrarnäsgatan 15, 164 40 Kista, Sweden, Tel. +46 859476680, Fax +46 859476690, www.panasonic-electric-works.se
▶ Poland	Panasonic Electric Works Polska sp. z o.o.	Jungmansgatan 12, 21119 Malmö, Tel. +46 40 697 7000, Fax +46 40 697 7099, www.panasonic-fire-security.com
▶ Spain	Panasonic Electric Works España S.A.	ul. Wotowska 9A, 02-583 Warszawa, Tel. +48 22 338-11-33, Fax +48 22 338-12-00, www.panasonic-electric-works.pl
▶ Switzerland	Panasonic Electric Works Schweiz AG	Barajas Park, San Severo 20, 28042 Madrid, Tel. +34 913293875, Fax +34 913292976, www.panasonic-electric-works.es
▶ United Kingdom	Panasonic Electric Works UK Ltd.	Grundstrasse 8, 6343 Rotkreuz, Tel. +41 (0) 41 7997050, Fax +41 (0) 41 7997055, www.panasonic-electric-works.ch
		Sunrise Parkway, Linford Wood, Milton Keynes, MK14 6LF, Tel. +44 (0) 1908 231555, Fax +44 (0) 1908 231599, www.panasonic-electric-works.co.uk
North & South America		
▶ USA	Panasonic Industrial Devices Sales Company of America	Two Riverfront Plaza, 7th Floor, Newark, NJ 07102-5490, Tel. 1-8003-442-112, www.pewa.panasonic.com
Asia Pacific / China / Japan		
▶ China	Panasonic Electric Works Sales (China) Co. Ltd.	Tower C 3rd Floor, Office Park, NO.5 Jinghua South Street, Chaoyang District, Beijing 100020, Tel. +86-10-5925-5988, Fax +86-10-5925-5980
▶ Hong Kong	Panasonic Industrial Devices Sales (HK) Co., Ltd.	Suite 301, 3/F, Chinachem Golden Plaza, 77 Mody Road, TST East, Kowloon, Hong Kong, Tel. +852-2529-3956, Fax +852-2528-6991
▶ Japan	Panasonic Corporation	1006, Oaza Kadoma, Kadoma-shi, Osaka 571-8501, Japan, Tel. +81-6-6908-1121, www.panasonic.net
▶ Singapore	Panasonic Industrial Devices Automation Controls Sales Asia Pacific	No.3 Bedok South Road, Singapore 469269, Tel. +65-6299-9181, Fax +65-6390-3953