

## V50 ... V53 Series, 3/2, 5/2 or 5/3 Solenoid actuated and pilot operated spool valve



- > Port size: 1/8 ... 1/2 (ISO G/NPT)
- > High flow in-line valves
- > Compact and robust design
- > Low power energy efficient solenoids
- > Flexible in-line and manifold mounting options



### Technical features

#### Medium:

Compressed air, filtered (40 µm) lubricated or non lubricated

#### Operation:

Softseal spool valve, solenoid and pilot actuated

#### Port size:

1/8, 1/4, 3/8, 1/2

#### Mounting position:

In-line or sub-base

#### Operating pressure:

Details of minimum and maximum pressure see overleaf.

#### Flow:

See tables overleaf

#### Ambient/Media temperature:

Pilot models:

-5°C ... +60°C (+23 ... +140 °F)

Solenoid models:

-5°C ... +50°C (+23 ... +122 °F);

Air supply must be dry enough to avoid ice formation at temperatures below +2°C (+35 °F).

#### Materials:

Body/sub-base: die-cast aluminium alloy or aluminium alloy, white painted

Softseal spool: NBR/aluminium alloy





Mounting sheets/screws: steel

Springs: stainless steel

### Electrical details for solenoid operators

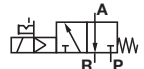

<b>Voltage tolerance</b>	± 10%
<b>Rating</b>	100% continuous duty
<b>Inlet orifice</b>	0,6 mm; V50
	0,8 mm; V51 ... V53
<b>Electrical connection (corresponding to chosen coil)</b>	EN 175301-803 - Form C; 15 mm; V50
	Industrial Standard; 22 mm; V51 ... V53
<b>Solenoid coil mounting</b>	Four positions x 90°
<b>Manual override</b>	Push and turn to lock (plastic)
<b>Protection class</b>	IP 65 (with sealed plug)

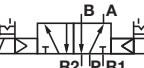
**Technical data, 3/2 and 5/2 way valves, solenoid actuated, standard models**

Symbol	Function	Port size	Actuation/return	Pilot supply	Operating pressure (bar)	Flow (l/min)	Manual override	Weight (kg)	Drawing No.	Model *1)
	3/2	G1/8	Solenoid/air	Internal	2 ... 8	480	Push & turn	0,120	1	V50A413A-A2
	3/2	G1/4	Solenoid/spring	Internal	2 ... 8	1020	Push & turn	0,203	2	V51B417A-A2
	3/2	G3/8	Solenoid/spring	Internal	2 ... 8	1705	Push & turn	0,350	2	V52C417A-A2
	3/2	G1/2	Solenoid/spring	Internal	2 ... 8	2480	Push & turn	0,353	2	V53D417A-A2
	3/2	G1/8	Solenoid/solenoid	Internal	2 ... 8	480	Push & turn	0,172	3	V50A411A-A2
	3/2	G1/4	Solenoid/solenoid	Internal	2 ... 8	1020	Push & turn	0,296	4	V51B411A-A2
	3/2	G3/8	Solenoid/solenoid	Internal	2 ... 8	1705	Push & turn	0,439	4	V52C411A-A2
	3/2	G1/2	Solenoid/solenoid	Internal	2 ... 8	2480	Push & turn	0,437	4	V53D411A-A2
	5/2	G1/8	Solenoid/air	Internal	2 ... 8	480	Push & turn	0,124	5	V50A513A-A2
	5/2	G1/4	Solenoid/spring	Internal	2 ... 8	1020	Push & turn	0,184	6	V51B517A-A2
	5/2	G3/8	Solenoid/spring	Internal	2 ... 8	1705	Push & turn	0,293	6	V52C517A-A2
	5/2	G1/2	Solenoid/spring	Internal	2 ... 8	2480	Push & turn	0,303	6	V53D517A-A2
	5/2	G1/8	Solenoid/solenoid	Internal	2 ... 8	480	Push & turn	0,176	7	V50A511A-A2
	5/2	G1/4	Solenoid/solenoid	Internal	2 ... 8	1020	Push & turn	0,292	8	V51B511A-A2
	5/2	G3/8	Solenoid/solenoid	Internal	2 ... 8	1705	Push & turn	0,452	8	V52C511A-A2
	5/2	G1/2	Solenoid/solenoid	Internal	2 ... 8	2480	Push & turn	0,190	8	V53D511A-A2

\*1) Insert coil code from below tables.

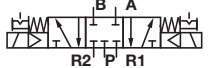
**Technical data, 5/3 way valves, solenoid actuated, standard models**

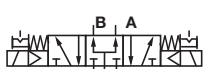
Symbol	Function	Port size	Mid position	Actuation/return	Pilot supply	Operating pressure (bar)	Flow (l/min)	Manual override	Weight (kg)	Drawing No.	Model *1)
	5/3	G1/8	APB	Solenoid/solenoid	Internal	3 ... 8	270	Push & turn	0,338	9	V50A611A-A2
	5/3	G1/4	APB	Solenoid/solenoid	Internal	3 ... 8	755	Push & turn	0,387	10	V51B611A-A2
	5/3	G3/8	APB	Solenoid/solenoid	Internal	3 ... 8	1190	Push & turn	0,565	11	V52C611A-A2
	5/3	G1/2	APB	Solenoid/solenoid	Internal	3 ... 8	1910	Push & turn	0,634	11	V53D611A-A2
	5/3	G1/8	COE	Solenoid/solenoid	Internal	3 ... 8	270	Push & turn	0,338	9	V50A711A-A2
	5/3	G1/4	COE	Solenoid/solenoid	Internal	3 ... 8	755	Push & turn	0,387	10	V51B711A-A2
	5/3	G3/8	COE	Solenoid/solenoid	Internal	3 ... 8	1190	Push & turn	0,565	11	V52C711A-A2
	5/3	G1/2	COE	Solenoid/solenoid	Internal	3 ... 8	1910	Push & turn	0,634	11	V53D711A-A2
	5/3	G1/8	COP	Solenoid/solenoid	Internal	3 ... 8	270	Push & turn	0,338	9	V50A811A-A2
	5/3	G1/4	COP	Solenoid/solenoid	Internal	3 ... 8	755	Push & turn	0,387	10	V51B811A-A2
	5/3	G3/8	COP	Solenoid/solenoid	Internal	3 ... 8	1190	Push & turn	0,565	11	V52C811A-A2
	5/3	G1/2	COP	Solenoid/solenoid	Internal	3 ... 8	1910	Push & turn	0,634	11	V53D811A-A2

\*1) Insert coil code from below tables.

APB = All Ports Blocked; COE = Centre Open Exhaust; COP = Centre Open Pressure



**Voltage codes and spare coils**
**V50 series only**

15 mm coil for connector interface acc. EN 175 301-803, form C				
	Voltage	Power Inrush/Hold	Model	Code
	12 V d.c.	2,9 W	V12958-A12	12A
	24 V d.c.	2,9 W	V12958-A13	13A
	110/120 V 50/60 Hz	3,7/3,1 VA	V12958-A18	18A
	220/240 V 50/60 Hz	3,7/3,1 VA	V12958-A19	19A

**V51 ... V53 series**

22 mm coil for connector interface acc. to industrial standard				
	Voltage	Power Inrush/Hold	Model	Code
	12 V d.c.	2 W	QM/48/12J/21	12J
	24 V d.c.	2 W	QM/48/13J/21	13J
	110/120 V 50/60 Hz	4/2,5 VA	QM/48/18J/21	18J
	220/240 V 50/60 Hz	6/5 VA	QM/48/19J/21	19J

**Connector plugs - include of delivery**



15 mm, EN 175301-803 (DIN 43650 B) Form C 2-pole + PE	Industrial standard 22 mm 2-pole + PE
	
V10027-D00	0657868

**Option selector**
**V5★ ★ ★ 1 ★ A-A2 ★ ★ ★**

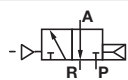
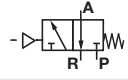
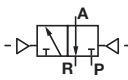
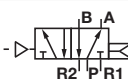
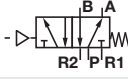
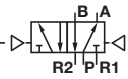

Thread size	Substitute
1/8"	<b>0</b>
1/4"	<b>1</b>
3/8"	<b>2</b>
1/2"	<b>3</b>
Thread	Substitute
G 1/8	<b>A</b>
G 1/4	<b>B</b>
G 3/8	<b>C</b>
G 1/2	<b>D</b>
NPT-Thread	Substitute
1/8 NPT	<b>P</b>
1/4 NPT	<b>R</b>
3/8 NPT	<b>S</b>
1/2 NPT	<b>T</b>

Voltage (Series V50)	Substitute
12 V d.c. 2,9 W	<b>12A</b>
24 V d.c. 2,9 W	<b>13A</b>
110/120 V a.c. (50/60 Hz) 3,7/3,1 VA	<b>18A</b>
220/240 V a.c. (50/60 Hz) 3,7/3,1 VA	<b>19A</b>
Voltage (Series V51 ... V53)	Substitute
12 V d.c. 2 W	<b>12J</b>
24 V d.c. 2 W	<b>13J</b>
110/120 V a.c. (50/60 Hz) 4/2,5 VA	<b>18J</b>
220/240 V a.c. (50/60 Hz) 6/5 VA	<b>19J</b>
Actuation	Substitute
Solenoid/air	<b>3</b>
Solenoid/spring	<b>7</b>
Solenoid/solenoid	<b>1</b>
Function	Substitute
3/2 Normally closed	<b>4</b>
5/2	<b>5</b>
5/3 All ports blocked	<b>6</b>
5/3 Centre open exhaust	<b>7</b>
5/3 Centre open pressure	<b>8</b>

**Technical data, 3/2 or 5/2 way valves, pilot actuated, standard models**

Symbol	Function	Port size	Pilot	Return	Operating pressure (bar)	Pilot pressure (bar)	Flow (l/min)	Weight (kg)	Drawing No.	Model	
	3/2	G1/8	Air	Air spring	0 ... 8	1,5 ... 8	480	0,061	12	V50A4D3A-XA090	
	3/2	G1/4	Air	Spring	0 ... 8	1,5 ... 8	1020	0,122	13	V51B4D7A-XA090	
	3/2	G3/8	Air	Spring	0 ... 8	2 ... 8	1705	0,295	13	V52C4D7A-XA090	
	3/2	G1/2	Air	Spring	0 ... 8	2 ... 8	2480	0,300	13	V53D4D7A-XA090	
	3/2	G1/8	Air	Air	0 ... 8	1,5 ... 8	480	0,074	14	V50A4DDA-XA020	
	3/2	G1/4	Air	Air	0 ... 8	1,5 ... 8	1020	0,134	15	V51B4DDA-XA020	
	3/2	G3/8	Air	Air	0 ... 8	2 ... 8	1705	0,324	15	V52C4DDA-XA020	
	3/2	G1/2	Air	Air	0 ... 8	2 ... 8	2480	0,326	15	V53D4DDA-XA020	
		5/2	G1/8	Air	Air spring	0 ... 8	1,5 ... 8	480	0,071	16	V50A5D3A-XA090
		5/2	G1/4	Air	Spring	0 ... 8	1,5 ... 8	1020	0,106	17	V51B5D7A-XA090
5/2		G3/8	Air	Spring	0 ... 8	2 ... 8	1705	0,236	17	V52C5D7A-XA090	
	5/2	G1/2	Air	Spring	0 ... 8	2 ... 8	2480	0,275	17	V53D5D7A-XA090	
	5/2	G1/8	Air	Air	0 ... 8	1,5 ... 8	480	0,084	18	V50A5DDA-XA020	
	5/2	G1/4	Air	Air	0 ... 8	1,5 ... 8	1020	0,134	19	V51B5DDA-XA020	
	5/2	G3/8	Air	Air	0 ... 8	2 ... 8	1705	0,236	19	V52C5DDA-XA020	
	5/2	G1/2	Air	Air	0 ... 8	2 ... 8	2480	0,750	19	V53D5DDA-XA020	

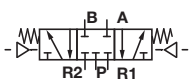
**Technical data, 5/3 way valves, pilot actuated, standard models**



Symbol	Function	Port size	Pilot	Mid position	Return	Operating pressure (bar)	Pilot pressure (bar)	Flow (l/min)	Weight (kg)	Drawing No.	Model
	5/3	G1/8	Air	APB	Air	0 ... 8	1,5 ... 8	270	0,095	20	V50A6DDA-XA020
	5/3	G1/4	Air	APB	Air	0 ... 8	1,5 ... 8	755	0,179	21	V51B6DDA-XA020
	5/3	G3/8	Air	APB	Air	0 ... 8	2 ... 8	1190	0,301	22	V52C6DDA-XA020
	5/3	G1/2	Air	APB	Air	0 ... 8	2 ... 8	1910	0,338	22	V53D6DDA-XA020
	5/3	G1/8	Air	COE	Air	0 ... 8	1,5 ... 8	270	0,095	20	V50A7DDA-XA020
	5/3	G1/4	Air	COE	Air	0 ... 8	1,5 ... 8	755	0,179	21	V51B7DDA-XA020
	5/3	G3/8	Air	COE	Air	0 ... 8	2 ... 8	1190	0,301	22	V52C7DDA-XA020
	5/3	G1/2	Air	COE	Air	0 ... 8	2 ... 8	1910	0,338	22	V53D7DDA-XA020
	5/3	G1/8	Air	COP	Air	0 ... 8	1,5 ... 8	270	0,095	20	V50A8DDA-XA020
	5/3	G1/4	Air	COP	Air	0 ... 8	1,5 ... 8	755	0,179	21	V51B8DDA-XA020
	5/3	G3/8	Air	COP	Air	0 ... 8	2 ... 8	1190	0,301	22	V52C8DDA-XA020
	5/3	G1/2	Air	COP	Air	0 ... 8	2 ... 8	1910	0,338	22	V53D8DDA-XA020

APB = All Ports Blocked; COE = Centre Open Exhaust; COP = Centre Open Pressure

**Option selector**

Thread size	Substitute	Air function	Substitute
1/8"	0	Pilot operated/pilot return	2
1/4"	1	Pilot operated/spring return	9
3/8"	2	Pilot port thread	Substitute
1/2"	3	G 1/8	A
		1/8 NPT	P
Thread	Substitute	Return	Substitute
G 1/8	A	Air spring	3
G 1/4	B	Spring	7
G 3/8	C	Air	D
G 1/2	D	Function	Substitute
NPT-Thread	Substitute	3/2 Normally closed	4
1/8 NPT	P	5/2	5
1/4 NPT	R	5/3 All ports blocked	6
3/8 NPT	S	5/3 Centre open exhaust	7
1/2 NPT	T	5/3 Centre open pressure	8

**Manifold system and blanking plates**

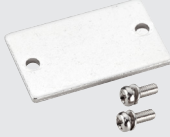
Manifold for 3 port valves			Blanking plate for 3 port valves		Manifold for 5 port valves		Blanking plate for 5 port valves	
								
For valve series	Page 14 ISO G thread	NPT thread	Page 15	Page 14 ISO G thread	NPT thread	Page 15		
V50 (1/8")	V50A3*1)	V50P3*1)	V500351	V50A5*1)	V50P5*1)	V500551		
V51 (1/4")	V51B3*1)	V51R3*1)	V510351	V51B5*1)	V51R5*1)	V510551		
V52 (3/8")	V52C3*1)	V52S3*1)	V520351	V52C5*1)	V52S5*1)	V520551		
V53 (1/2")	V53D3*1)	V53T3*1)	V530351	V53D5*1)	V53T5*1)	V530551		

\*1) Number of station 02 ... 09 for 2 ... 9 stations  
 Number of station 10 for 10 stations

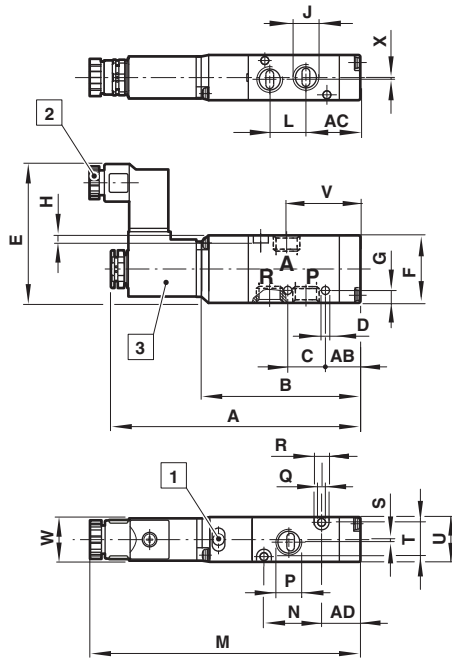
**3/2 Single solenoid pilot valve, 1/8" port  
Air return**
**1**

**1** Manual override (Push and Turn)

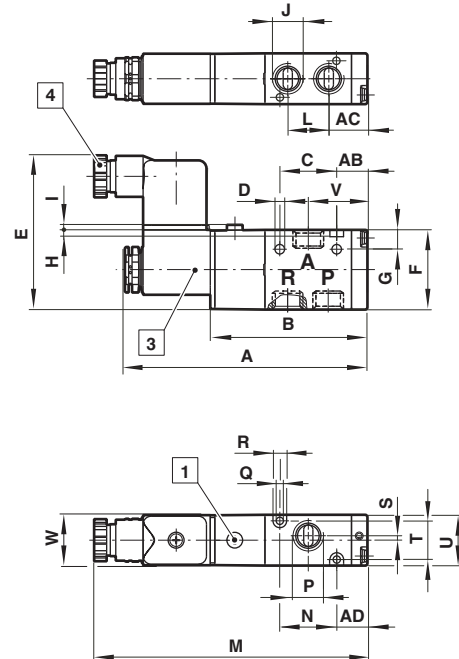
**2** Gland size Pg 7

**3/2 Single solenoid pilot valve,  
1/4"... 1/2" ports  
Spring return**
**2**

**3** Solenoid rotates 2 x 180° (V50), 4 x 90° (V51... V53)

**4** Gland size Pg 9

 Dimensions in mm  
Projection/First angle

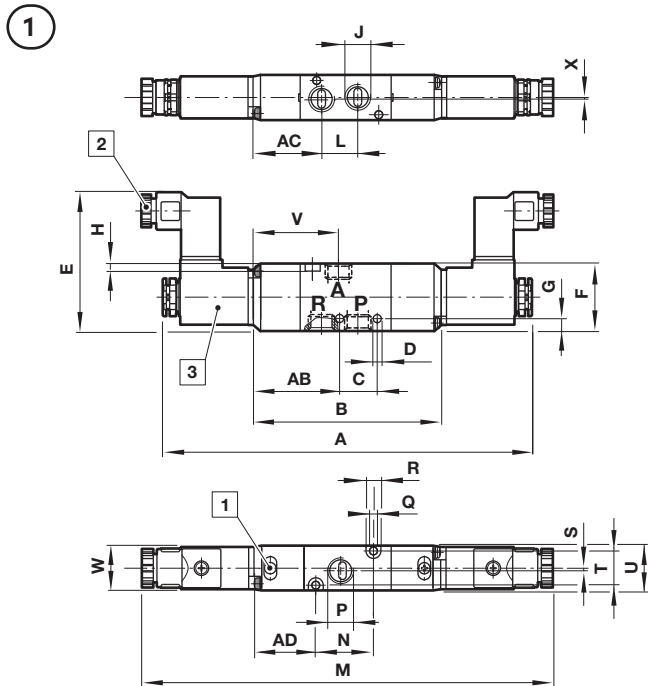
Series	Drawing	A	AB	AC	AD	B	C	D	E	F	G	H	I	J	L	M	N	P	Q	R	S	T	U	V	W	X
V50	1	99,5	13,5	21,5	15,5	65	15	3,2	55,5	27	5	3	—	1/8"	14,5	108	23	1/8"	3,2	6	1	13	18	29,5	16	0,5
V51	2	106,5	13,5	17	13,5	69	25	4,2	67	35	8,5	3	3	1/4"	18	120	25	1/4"	3,2	6	2	17	22,5	26	22	—
V52	2	126,5	13	26	15	89	26	4,5	73	46,5	39,5	4	3	3/8"	26	139,5	41	3/8"	4,5	8	—	23	30	41	22	—
V53	2	133	12,5	27	15	96	29	4,5	73	46,5	39,5	4	3	1/2"	29	146	48	1/2"	4,2	8	2,5	23	30	40,5	22	—

**3/2 Double solenoid pilot valve, 1/8" port**

1 Manual override (Push and Turn)

2 Gland size Pg 7

**3/2 Double solenoid pilot valve, 1/4" ... 1/2" ports**

Dimensions in mm  
Projection/First angle

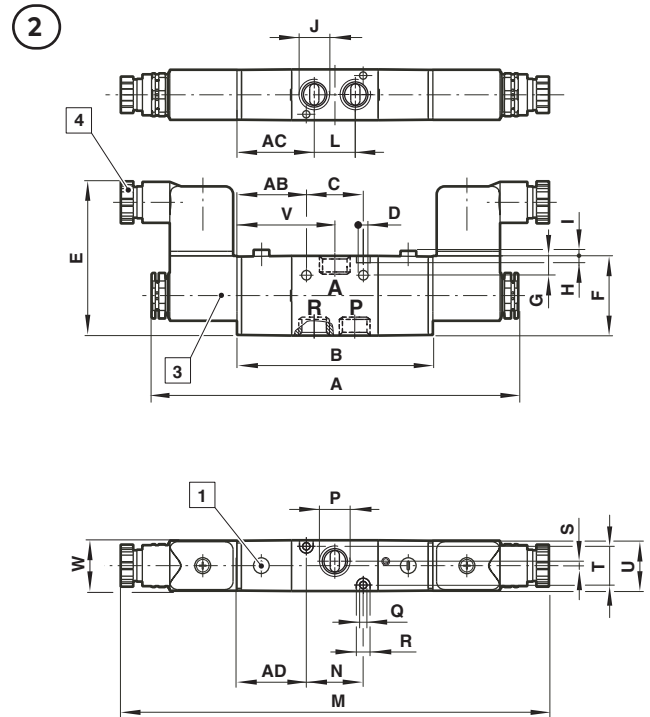

3 Solenoid rotates 2 x 180° (V50), 4 x 90° (V51 ... V53)

4 Gland size Pg 9

Series	Drawing	A	AB	AC	AD	B	C	D	E	F	G	H	I	J	L	M	N	P	Q	R	S	T	U	V	W	X
V50	3	144,5	36,5	29	27	76,5	15	3,2	55,5	27	5	3	—	1/8"	14,5	161,5	23	1/8"	3,2	6	1	13	18	35,5	16	0,5
V51	4	144,5	30,5	34	30,5	86	25	4,2	67	35	8,5	3	3	1/4"	18	188	25	1/4"	3,2	6	2	17	22,5	43	22	—
V52	4	182	31	44	33	107	26	4,5	73	46,5	39,5	4	3	3/8"	26	208	41	3/8"	4,5	8	—	23	30	59	22	—
V53	4	188	30,5	45	33	114	29	4,5	73	46,5	39,5	4	3	1/2"	29	214	48	1/2"	4,2	8	2,5	23	30	58,5	22	—

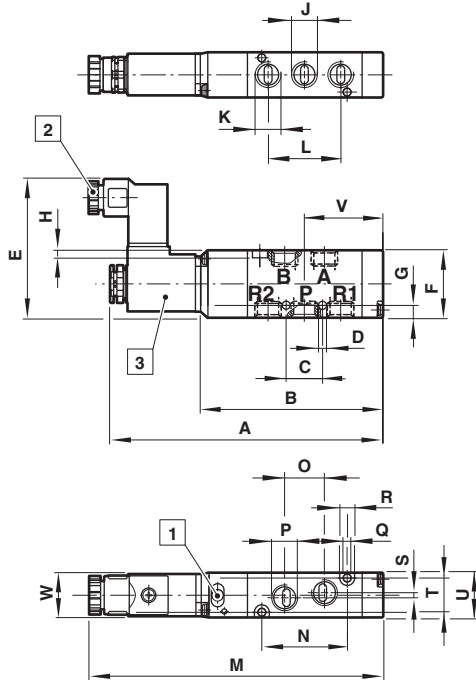
**5/2 Single solenoid pilot valve, 1/8" port  
Air return**
**5**

**1** Manual override (Push and Turn)

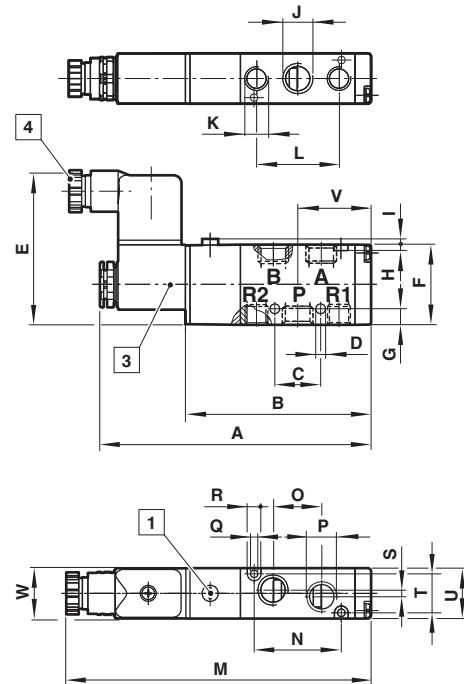
**2** Gland size Pg 7

**5/2 Single solenoid pilot valve,  
1/4"... 1/2" ports  
Spring return**
**6**

**3** Solenoid rotates 2 x 180° (V50), 4 x 90° (V51 ... V53)

**4** Gland size Pg 9

 Dimensions in mm  
Projection/First angle

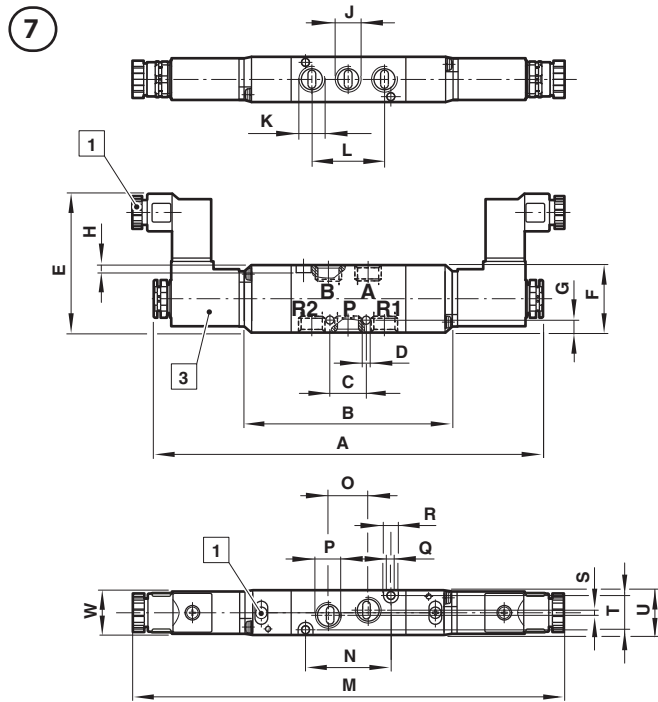

Series	Drawing	A	B	C	D	E	F	G	H	I	J	K	L	M	N	O	P	Q	R	S	T	U	V	W
V50	5	110	76	14,5	3,2	54	27	5	3	—	1/8"	1/8"	29	118,5	34	16	1/8"	3,2	6	2	13	18	32,5	16
V51	6	118,5	81	20	4,2	67	35	7	3	3	1/4"	1/8"	36	132	38	21	1/4"	3,2	6	3	17	22,5	32	22
V52	6	145,5	108	26	5,5	73	46,5	4,5	4	3	3/8"	3/8"	52	158,5	13	30	3/8"	4,5	8	—	23	30	45	22
V53	6	157	120	29	4,5	73	46,5	7	4	3	1/2"	1/2"	58	170	72	28	1/2"	4,2	8	4,5	23	30	51	22



**5/2 Double solenoid pilot valve, 1/8" port**

- 1 Manual override (Push and Turn)  
 2 Gland size Pg 7

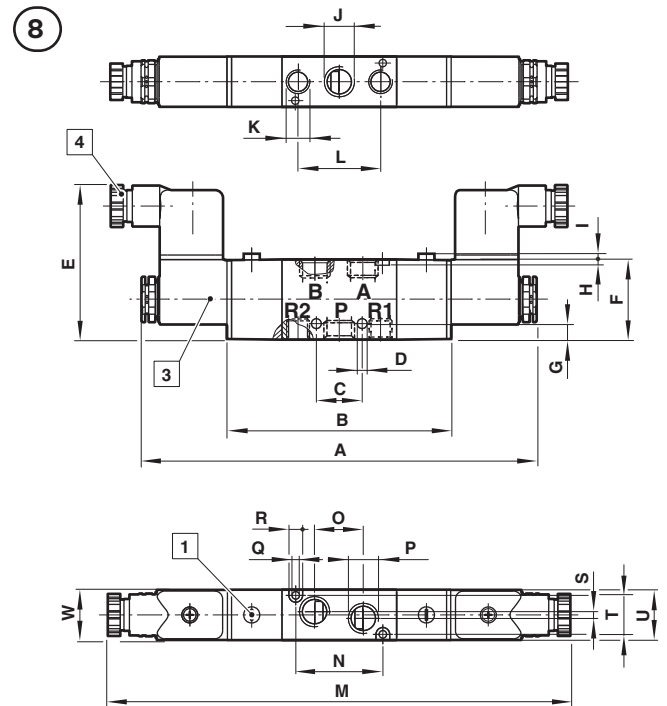
**5/2 Double solenoid pilot valve, 1/4" ... 1/2" ports**

 Dimensions in mm  
 Projection/First angle

- 3 Solenoid rotates 2 x 180° (V50), 4 x 90° (V51 ... V53)  
 4 Gland size Pg 9

Series	Drawing	A	B	C	D	E	F	G	H	I	J	K	L	M	N	O	P	Q	R	S	T	U	W
V50	7	155	87	14,5	3,2	55	27	5	3	—	1/8"	1/8"	29	172	34	16	1/8"	3,2	6	2	13	18	16
V51	8	173	98	20	4,2	67	35	7	3	3	1/4"	1/8"	36	200	38	21	1/4"	3,2	6	3	17	22,5	22
V52	8	201	126	26	5,5	73	46,5	4,5	4	3	3/8"	3/8"	52	228	13	30	3/8"	4,5	8	—	23	30	22
V53	8	212	138	29	4,5	73	46,5	7	4	3	1/2"	1/2"	58	238	72	28	1/2"	4,2	8	4,5	23	30	22

**5/3 Double solenoid pilot valve, 1/8" port**
**5/3 Double solenoid pilot valve, 1/4" port**

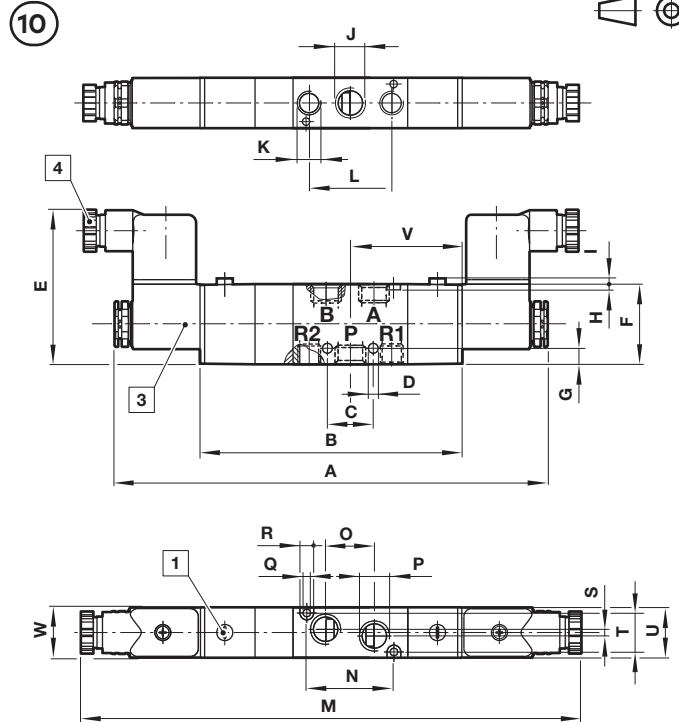
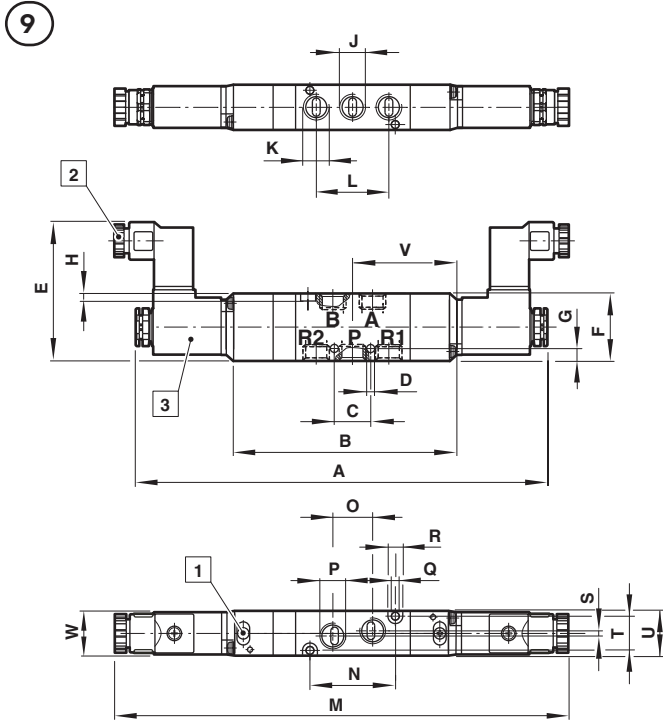
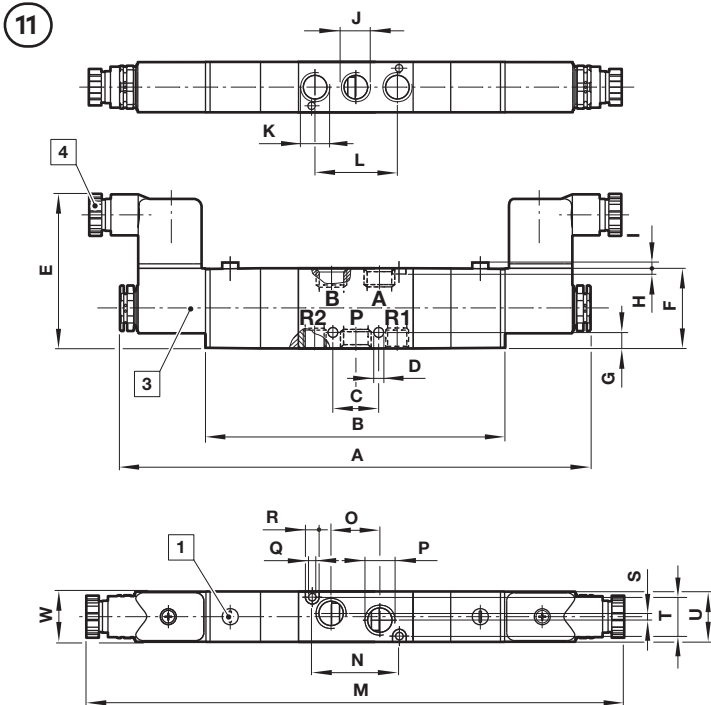
 Dimensions in mm  
 Projection/First angle

**5/3 Double solenoid pilot valve, 3/8" and 1/2" ports**

- 1 Manual override (Push and Turn)
- 2 Gland size Pg 7
- 3 Solenoid rotates 2 x 180° (V50), 4 x 90° (V51 ... V53)
- 4 Gland size Pg 9

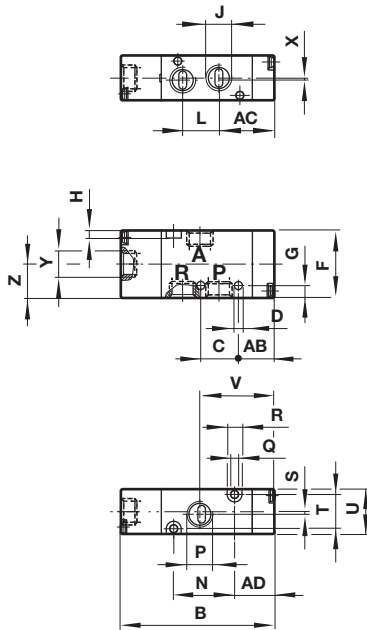
Series	Drawing	A	B	C	D	E	F	G	H	I	J	K	L	M	N	O	P	Q	R	S	T	U	V	W
V50	9	164	96	14,5	3,2	55	27	5	3	—	1/8"	1/8"	29	181	34	16	1/8"	3,2	6	2	13	18	43,5	16
V51	10	194	119	20	4,2	67	35	7	3	3	1/4"	1/8"	36	221	38	21	1/4"	3,2	6	3	17	22,5	48,5	22
V52	11	254,5	179,5	26	5,5	73	46,5	4,5	4	3	3/8"	3/8"	52	281,5	13	30	3/8"	4,5	8	—	23	30	—	22
V53	11	265,5	191,5	29	4,5	73	46,5	7	4	3	1/2"	1/2"	58	291,5	72	28	1/2"	4,2	8	4,5	23	30	—	22

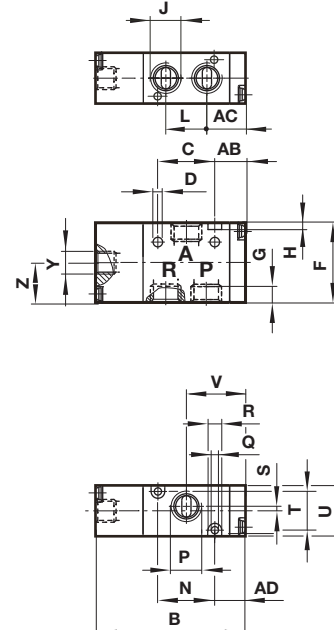
**3/2 Single air pilot valve, 1/8" port**  
**Air spring return**
**12**

**3/2 Single air pilot valve, 1/4" ... 1/2" ports** Dimensions in mm  
**Spring return** Projection/First angle

**13**

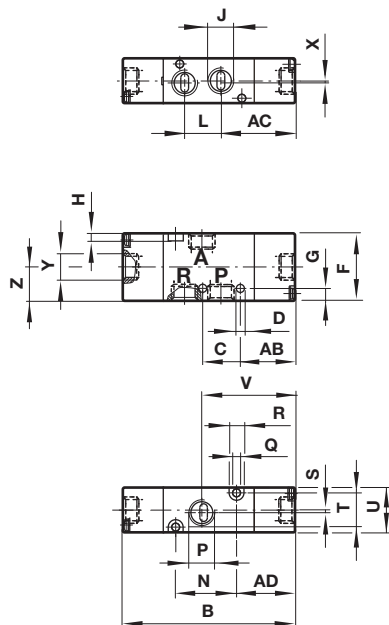
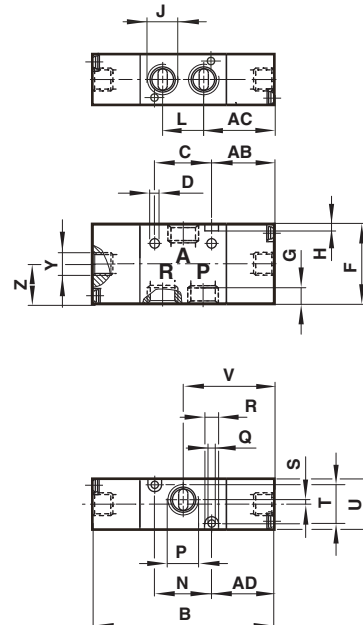
Series	Drawing	AB	AC	AD	B	C	D	F	G	H	J	L	N	P	Q	R	S	T	U	V	X	Y	Z
V50	12	13,5	21,5	15,5	61,5	15	3,2	27	5	3	1/8"	14,5	23	1/8"	3,2	6	1	13	18	29,5	0,5	1/8"	13,5
V51	13	13,5	17	13,5	65,5	25	4,2	35	8,5	3	1/4"	18	25	1/4"	3,2	6	2	17	22,5	26	—	1/8"	17,5
V52	13	13	26	15	87	26	4,5	46,5	39,5	4	3/8"	26	41	3/8"	4,5	8	—	23	30	41	—	1/8"	17
V53	13	12,5	27	15	94	29	4,5	46,5	39,5	4	1/2"	29	48	1/2"	4,2	8	2,5	23	30	40,5	—	1/8"	17

**3/2 Double air pilot valve, 1/8" port**
**14**

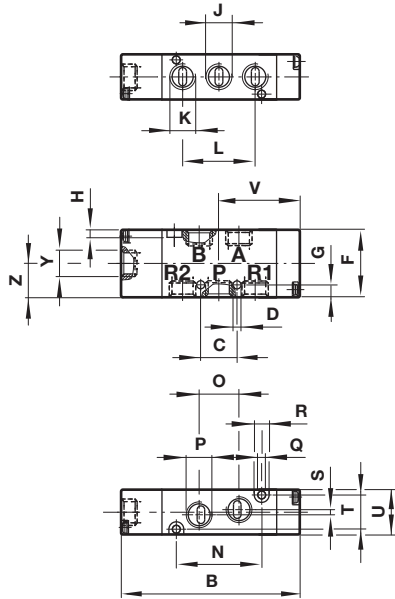
**3/2 Double air pilot valve, 1/4" ... 1/2" ports**
**15**

Series	Drawing	AB	AC	AD	B	C	D	F	G	H	J	L	N	P	Q	R	S	T	U	V	X	Y	Z
V50	14	13,5	21,5	15,5	69	15	3,2	27	5	3	1/8"	14,5	23	1/8"	3,2	6	1	13	18	29,5	0,5	1/8"	13,5
V51	15	13,5	17	13,5	79	25	4,2	35	8,5	3	1/4"	18	25	1/4"	3,2	6	2	17	22,5	26	—	1/8"	17,5
V52	15	13	26	15	103	26	4,5	46,5	39,5	4	3/8"	26	41	3/8"	4,5	8	—	23	30	41	—	1/8"	17
V53	15	12,5	27	15	110	29	4,5	46,5	39,5	4	1/2"	29	48	1/2"	4,2	8	2,5	23	30	40,5	—	1/8"	17

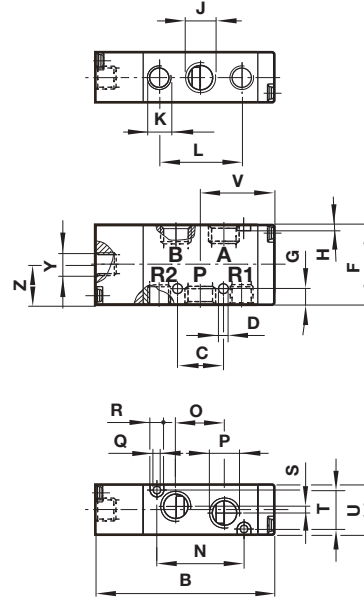
**5/2 Single air pilot valve, 1/8" port**  
**Air spring return**
**16**

**5/2 Single air pilot valve, 1/4"... 1/2" ports** Dimensions in mm  
**Spring return** Projection/First angle

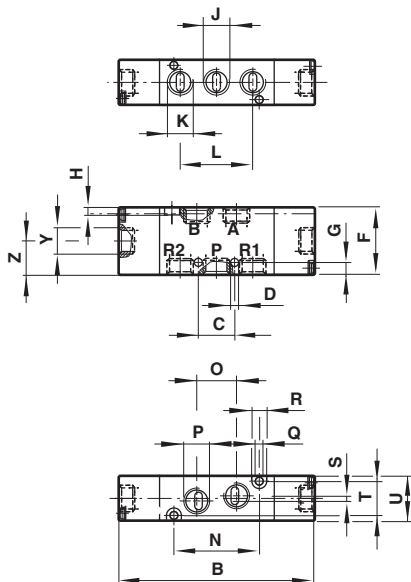
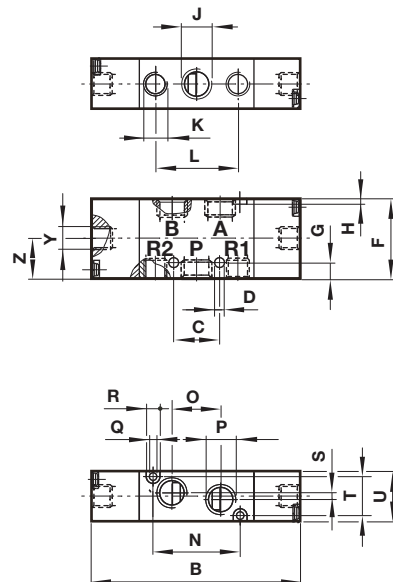
**17**

Series	Drawing	B	C	D	F	G	H	J	K	L	N	L	O	P	Q	R	S	T	U	V	Y	Z	Z
V50	16	72,5	14,5	3,2	27	5	3	1/8"	1/8"	29	34	14,5	16	1/8"	3,2	6	2	13	18	32,5	1/8"	13,5	13,5
V51	17	77,5	20	4,2	35	7	3	1/4"	1/8"	36	38	18	21	1/4"	3,2	6	3	17	22,5	32	1/8"	17,5	17,5
V52	17	106	26	5,5	46,5	4,5	4	3/8"	3/8"	52	13	26	30	3/8"	4,5	8	—	23	30	45	1/8"	17	17
V53	17	118	29	4,5	46,5	7	4	1/2"	1/2"	58	72	29	28	1/2"	4,2	8	4,5	23	30	51	1/8"	17	17

**5/2 Double air pilot valve, 1/8" port**
**18**

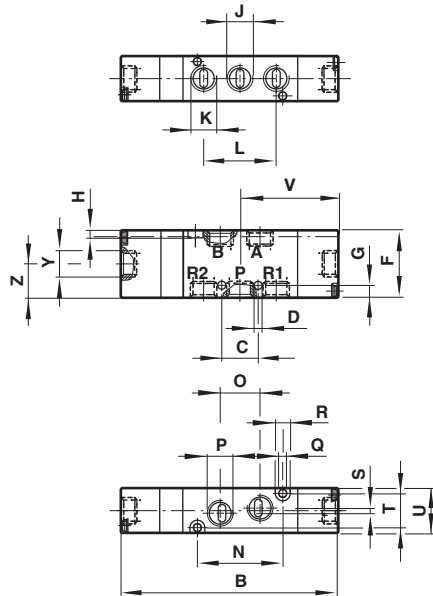
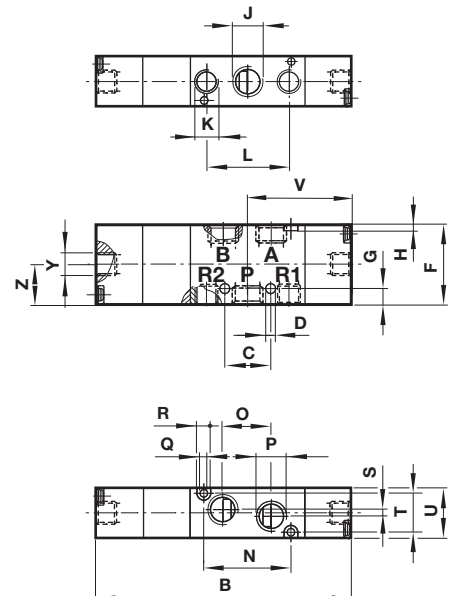
**5/2 Double air pilot valve, 1/4"... 1/2" ports**
**19**

Series	Drawing	B	C	D	F	G	H	J	K	L	N	O	P	Q	R	S	T	U	Y	Z
V50	18	80	14,5	3,2	27	5	3	1/8"	1/8"	29	34	16	1/8"	3,2	6	2	13	18	1/8"	13,5
V51	19	91	20	4,2	35	7	3	1/4"	1/8"	36	38	21	1/4"	3,2	6	3	17	22,5	1/8"	17,5
V52	19	122	26	5,5	46,5	4,5	4	3/8"	3/8"	52	13	30	3/8"	4,5	8	—	23	30	1/8"	17
V53	19	134	29	4,5	46,5	7	4	1/2"	1/2"	58	72	28	1/2"	4,2	8	4,5	23	30	1/8"	17

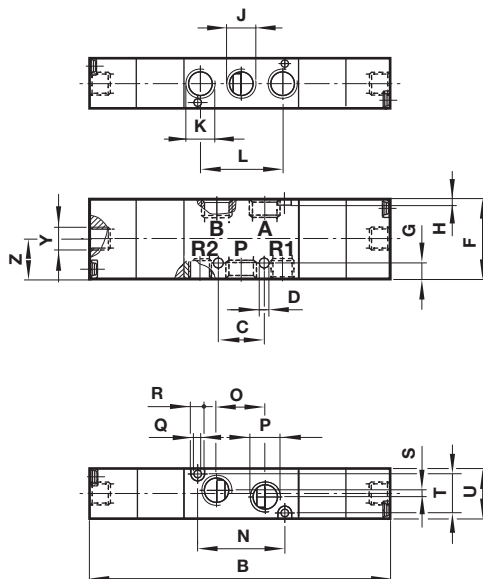
**5/3 Double air pilot valve, 1/8" port**
**20**

**5/3 Double air pilot valve, 1/4" port**
**21**

 Dimensions in mm  
 Projection/First angle

**5/3 Double air pilot valve, 3/8" and 1/2" ports**
**22**

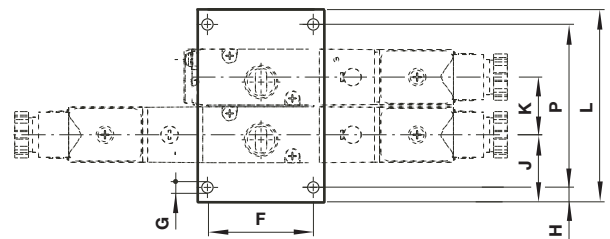
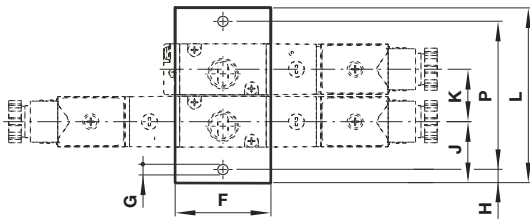
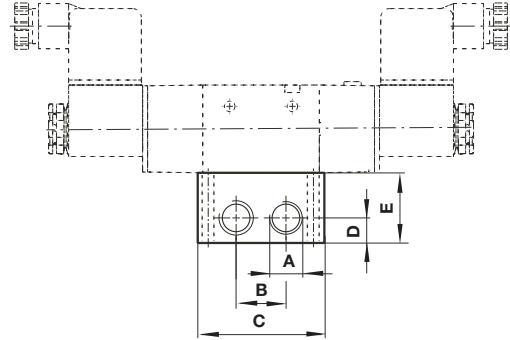
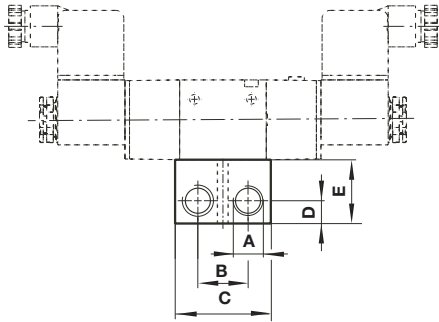
Series	Drawing	B	C	D	F	G	H	J	K	L	N	O	P	Q	R	S	T	U	V	Y	Z
V50	20	89	14,5	3,2	27	5	3	1/8	1/8"	29	34	16	1/8"	3,2	6	2	13	18	40	1/8"	13,5
V51	21	112	20	4,2	35	7	3	1/4	1/8"	36	38	21	1/4"	3,2	6	3	17	22,5	45,5	1/8"	17,5
V52	22	175,5	26	5,5	46,5	4,5	4	3/8	3/8"	52	13	30	3/8"	4,5	8	—	23	30	87,5	1/8"	17
V53	22	187,5	29	4,5	46,5	7	4	1/2	1/2"	58	72	28	1/2"	4,2	8	4,5	23	30	93,5	1/8"	17

**Manifold system, 3/2 valves**  
**for V50 and V51**
**for V52 and V53**

 Dimensions in mm  
 Projection/First angle

Series	A	B	C	D	E	Ø G	H	J	K	L	P	Weight (kg)
V50	1/4"	22	42	10	28	4,5	5	19	19	19 + (N x 19)	9 + (N x 19)	0,05 + (N x 0,05)
V51	1/4"	22	42	10	28	4,5	6	27	23	31 + (N x 23)	19 + (N x 23)	0,08 + (N x 0,06)
V52	3/8"	26	66	11,5	27	4,5	5	25	31	19 + (N x 31)	9 + (N x 31)	0,06 + (N x 0,11)
V53	1/2"	30	72	15	32	4,5	5	25	31	19 + (N x 31)	9 + (N x 31)	0,07 + (N x 0,14)

N = Number of stations 2 ... 10

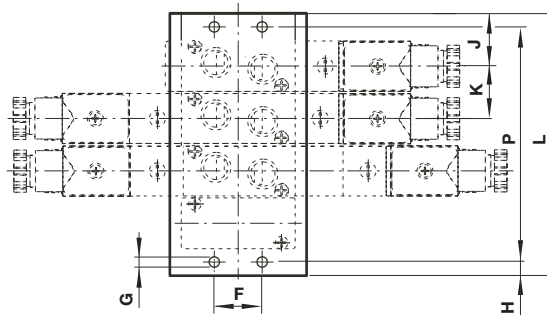
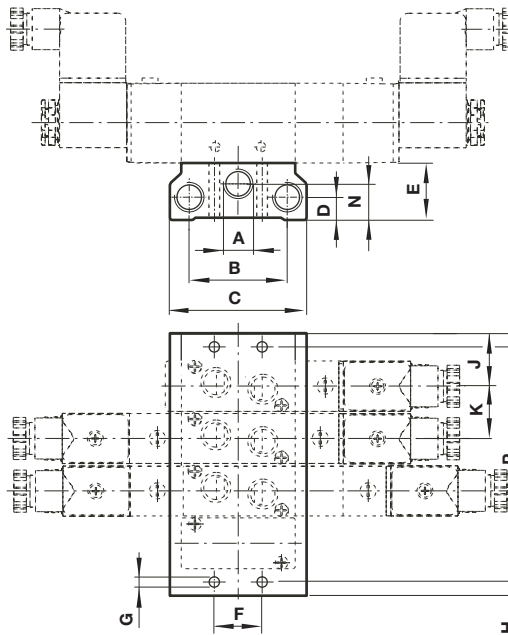
**Manifold system, 5/2 and 5/3 valves**

Series	A	B	C	D	E	F	Ø G	H	J	K	L	P	Weight (kg)
V50	1/4"	40	58	11	25	20	4,5	5	19	19	19 + (N x 19)	9 + (N x 19)	0,04 + (N x 0,04)
V51	1/4"	43	60	10	25	21	4,5	6	23	23	23 + (N x 23)	11 + (N x 23)	0,07 + (N x 0,06)
V52	3/8"	61	84	12	27	30	4,5	5	25	31	19 + (N x 31)	9 + (N x 31)	0,06 + (N x 0,09)
V53	1/2"	58	96	13	30	30	4,5	5	25	31	19 + (N x 31)	9 + (N x 31)	0,08 + (N x 0,15)

N = Number of stations 2 ... 10

## Blanking plate

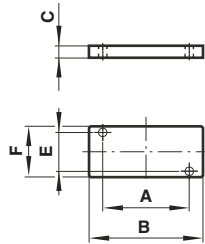

Dimensions in mm  
Projection/First angle



For Function	Valve port size	A	B	C	E	F	Weight (kg)	Model
3/2	1/8	23	35	2	13	18	0,01	V500351
3/2	1/4	25	38	2	17	22,5	0,02	V510351
3/2	3/8	41	55	2	23	30	0,03	V520351
3/2	1/2	48	62	2	23	30	0,06	V530351
5/2	1/8	34	43	2	13	18	0,01	V500551
5/2	1/4	38	50	2	17	22,5	0,02	V510551
5/2	3/8	13	74	2	23	30	0,03	V520551
5/2	1/2	72	86	2	23	30,5	0,08	V530551

## Warning

These products are intended for use in industrial compressed air systems only. Do not use these products where pressures and temperatures can exceed those listed under **»Technical features/data«**.

Before using these products with fluids other than those specified, for non-industrial applications, life-support systems or other applications not within published specifications, consult Norgren.

Through misuse, age, or malfunction, components used in fluid power systems can fail in various modes.

The system designer is warned to consider the failure modes of all component parts used in fluid power systems and to provide adequate safeguards to prevent personal injury or damage to equipment in the event of such failure.

System designers must provide a warning to end users in the system instructional manual if protection against a failure mode cannot be adequately provided.

System designers and end users are cautioned to review specific warnings found in instruction sheets packed and shipped with these products.