

Preset counters, electronic

LCD preset counters **Multifunctional – pulse, frequency, time – 1...6 presets (AC+DC)** **Codix 923 / 924**



The multifunction preset counters Codix 923 / 924 can be used universally. These preset pulse counters, tachometers or preset timers with up to 6 presets can solve a wide variety of control and monitoring tasks in every application.

With their two-line display in 4 different versions the counters are very easy to read and simple to programme using the clearly laid-out decade keys. Complex control tasks can be carried out using a batch count or total count function.



DC 10 ... 30 V Supply voltage	AC 10 ... 240 V Supply voltage	-20...+65°C Temperature range	000000 DIN 48x48	HRA Frequency meter HRA	Prog Menu-driven programming	IP65 High protection level	max. 65 kHz Count frequency	Plug-in screw terminal	1 ... 6 Presets	Multifunctional
2x6 LCDs LCD display	Multicolor display	Position Position display	Batch Batch counter	Σ Totalizer						

Multifunctional

- Counter, tachometer and timer in one device.
- Can be used a preset counter, batch counter, totalizer or position display with tracking preset.
- Presets: 923: 1, 924: 2, 924-4: 4, 924-6: 6.
- Relay or optocoupler outputs.
- Many different count modes for pulse inputs, time and frequency.
- Scalable input using multiplication and division factor
- Set value.
- Averaging, start delay (tachometer).
- Step or tracking presets (eliminate the need for reprogramming of the pre-signal).
- Multi-range supply voltage.

Fast and user-friendly

- Direct input of the presets via the front keys or via the Teach-In input.
- Fast installation thanks to plug-in screw terminals.
- Max. count frequency 65 kHz.
- Simultaneous display of the actual and of the preset value, or of the actual value and of the batch / totalizing counter.
- Annunciators for the displayed preset and for the output status.
- 3 predefined parameter settings.
- Direct entry into the programming.
- Minimal installation depth.
- 4-stage RESET modes.
- 3-stage key lockout.
- Multicolor display for improved differentiation.

Order code

6.92 X . 0 1 X X . X X X
a b c d e f

a Number of presets

- 3 = 1 preset
- 4 = 2, 4 or 6 presets

b Output

- 0 = relays
- 1 = optocouplers (only a = 4)²⁾

c LCD options

- 0 = no backlighting
- 1 = green backlighting¹⁾
- 2 = LED look, negative, red backlighting¹⁾
- 3 = multicolor, negative red/green backlighting

d Supply voltage

- 0 = 100 ... 240 V AC, ±10 %
- 2 = 24 V AC, ±10 %
- 3 = 10 ... 30 V DC

e Input trigger level

- 0 = standard level (HTL)
- A = 4 ... 30 V DC level¹⁾

f Version

- 0 = standard 923/924
- B = 6 optocoupler outputs²⁾
- 924-6 (only b = 1)
- C = 4 relay outputs²⁾
- 924-4 (only b = 0)

Delivery specification

- Preset counter
- Mounting clip
- 8 pin screw terminal
- 7 pin screw terminal
- Operating instructions

Stock types

6.923.0100.000	6.924.0100.000
6.923.0100.300	6.924.0100.300
6.923.0101.000	6.924.0101.000
6.923.0101.300	6.924.0101.300
6.923.0102.000	6.924.0102.000
6.923.0102.300	6.924.0102.300
6.923.0103.000	6.924.0103.000
6.923.0103.300	6.924.0103.300
	6.924.0100.00C
	6.924.0100.30C
	6.924.0113.00B
	6.924.0113.30B

Additional inputs, outputs or interface types on request

1) 24 V AC on request

2) Not possible in 24 V AC.

Preset counters, electronic

LCD preset counters Multifunctional – pulse, frequency, time – 1...6 presets (AC+DC) Codix 923 / 924

Accessories / Mounting examples

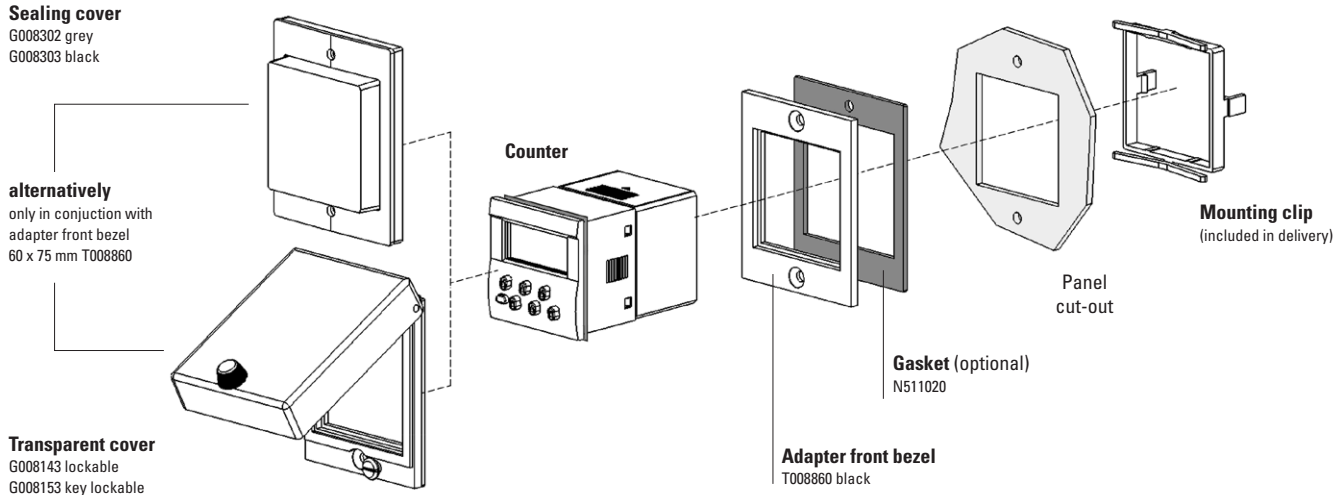

		Type / size	Description		Order no.	suitable gasket
Adapter front bezel		55 x 55 mm [2.17 x 2.17]	for cut-out 50 x 50 mm [1.97 x 1.97"] or ø 50,5 mm [1.99"] to cut-out 45 x 45 mm [1.77 x 1.77"]	grey black	T008170 T008171	N511017
		55 x 55 mm [2.17 x 2.17]	for cut-out 50 x 50 mm [1.97 x 1.97"] to cut-out 45 x 45 mm [1.77 x 1.77"]	black	T008853	N511004
		60 x 75 mm [2.36 x 2.95]	for cut-out 50 x 50 mm [1.97 x 1.97"] to cut-out 45 x 45 mm [1.77 x 1.77"]	black	T008860	N511020
		72 x 72 mm [2.83 x 2.83]	for cut-out 68 x 68 mm [2.68 x 2.68"] to cut-out 45 x 45 mm [1.77 x 1.77"]	grey black Mating clip	T008176 T008177 T009420	N511016
		ø 72 mm [2.83]	for cut-out ø 60 mm [2.36"] to cut-out 45 x 45 mm [1.77 x 1.77"]	black	N510226	–
Sealing cover IP65		K2	only in conjunction with adapter front bezel 60 x 75 mm T008860	transparent / grey	G008302	–
				transparent / black	G008303	–
Transparent cover IP65		2 Dv (mounted on bezel)	cover lockable, for cut-out 50 x 50 [1.97 x 1.97], only in conjunction with adapter front bezel 60 x 75 mm T008860	transparent / black	G008143	–
		2 Dvs (mounted on bezel)	cover key lockable, for cut-out 50 x 50 [1.97 x 1.97], only in conjunction with adapter front bezel 60 x 75 mm T008860	transparent / black	G008153	–
Mounting frame		cut-out 50 x 50 mm [2.36 x 2.36]	for snap-on mounting on 35 mm [1.38"] top-hat DIN rail	chromated	G300003	
Screw terminal (replacement part)			1 ... 8, pitch 3.81 9 ... 15 (for 923 / 924), pitch 5.08 9 ... 15 (for 924-4 / 924-6), pitch 5.08 16 ... 20 (for 924-4 / 924-6), pitch 3.81	8-pin 7-pin 7-pin 5-pin	N100498 N100548u002 N100400u002 N100399u002	

incl. in delivery

Preset counters, electronic

LCD preset counters	Multifunctional – pulse, frequency, time – 1...6 presets (AC+DC)	Codix 923 / 924
----------------------------	---	------------------------

Technical data

General technical data		
Display	standard	2 line 2 x 6 digits LCD display positive green with optional backlighting
	LED look multicolor	negative red backlighting upper line negative, red backlighting lower line negative, red or green backlighting (programmable)
Operating temperature		-20 °C ... +65 °C [-4 °F ... +149 °F] (non-condensing)
Storage temperature		-25 °C ... +75 °C [-13 °F ... +167 °F]
Relative humidity at +40 °C [+104 °F]		93 % (non-condensing)
Altitude		up to 2000 m [6562']
Mechanical characteristics		
Protection		IP65 (front side)
Weight		approx. 125 g [4.41 oz]
Electrical characteristics		
Sensor supply voltage	AC (50/60 Hz)	100 ... 240 V AC, ±10 %, max. 15 VA 24 V AC ±10 %, max. 6 VA
	DC	10 ... 30 V, max. 5.5 W
External fuse protection	100 ... 240 V AC	T 0.1 A
	24 V AC	T 0.315 A
	10 ... 30 V DC	T 0.2 A
Data retention		> 10 years, EEPROM
Input modes	pulse counters:	Count direction (cnt.dir), Difference (up.dn), Addition A+B (up.up), phase discriminator x1, x2, x4 (quad, quad x2, quad x4), Ratio (A/B), Ratio in % ((A-B)/A x100%)
	frequency meter:	A, A-B, A+B quad, A/B, (A-B)/A x 100 %
	timer:	4 Start modes: FrErun, Auto, InpA.InpB., InpB.InpB.
Sensor supply voltage	AC supply	24 V DC ±15 %, 80 mA
	DC supply	max. 80 mA, external supply voltage is connected through
EMC standards		EN 55011 class B, EN 61000-6-2, EN 61000-6-3
Device safety	designed to protection class application area	EN 61010-1, EN 61010-2-201 2 pollution level 2
UL approval		file E128604

Inputs		
Count inputs		A and B
Polarity of the inputs		programmable for all inputs in common NPN/PNP
Input resistance		5 kΩ
Count frequency	pulse counters	max. 55 kHz
	tachometers	max. 65 kHz (details see manual) can be damped to 30 Hz (mechanical contacts)
Control / Reset input		MPI, Lock, Gate, Reset
Min pulse duration of signal and control inputs		10 ms / 1 ms
Switching levels with AC supply	HTL level:	LOW 0 ... 4 V DC HIGH 12 ... 30 V DC
	4 ... 30 V DC:	LOW 0 ... 2 V DC HIGH 3.5 ... 30 V DC
Switching levels with DC supply	HTL level:	LOW 0 ... 0.2 x U _B HIGH 0.6 x U _B ... 30 V DC
	4 ... 30 V DC:	LOW 0 ... 2 V DC HIGH 3.5 ... 30 V DC
Pulse shape		variable, Schmitt-Trigger characteristics

Outputs		
Outputs relay version (1 changeover contact with 923)		
Switching voltage		max. 250 V AC / 110 V DC
Switching current		max. 3 A AC/DC min. 30 mA DC
Switching capacity		max. 750 VA / 90 W
Output 1 (Relay closing contact, programmable as normally open (NO) or normally closed (NC))		
Mech. service life (switching cycles)		2 x 10 ⁷
N° of switching cycles at 3 A / 250 V AC		1 x 10 ⁵
N° of switching cycles at 3 A / 30 V DC		1 x 10 ⁵
Output 2 (Relay with changeover contact)		
Mech. service life (switching cycles)		2 x 10 ⁷
N° of switching cycles at 3 A / 250 V AC		5 x 10 ⁴
N° of switching cycles at 3 A / 30 V DC		5 x 10 ⁴
Outputs optocoupler version		
Output 1 and 2 (npn optocoupler)		
switching power		30 V DC / 10 mA
	U _{CESAT} at I _C = 10 mA	max. 2.0 V
	U _{CESAT} at I _C = 5 mA	max. 0.4 V
Reaction time of the outputs (pulse / time)	relay	approx. 13 ms
	optocoupler	approx. 1 ms Details see instruction manual
Response time of the frequency meter		100/600 ms details see instruction manual

Preset counters, electronic

LCD preset counters

Multifunctional – pulse, frequency, time – 1...6 presets (AC+DC)

Codix 923 / 924

Codix 924-4 and 924-6

The preset counters 924-4 and 924-6 vary from the standard counters 923 and 924 as follows:

- Relay version: 924-4, 4 presets, 2 additional relays
- Optocoupler version: 924-6: 6 presets, 4 additional optocoupler outputs
- No tracking presets
- Presets 1 and 4 affect the batch or total counter
- Presets 2, 3, 5 and 6 (Type: 924-6) or presets 2 and 3 (Type 924-4) affect the main counter
- Preset 2 is the main preset; it triggers the automatic reset
- Preset 2 is likewise the main preset for all further counting modes (the other presets are pre-signals)

Additional technical data Codix 924-4

Output 3

Relay with closing contact (programmable as normally closed NC or normally open NO)

Switching voltage	max. 125 V AC / 110 V DC
Switching current	max. 1 A AC / 1 A DC min. 1 mA AC/DC
Switching capacity	max. 62.5 VA / 30 W
Mech. service life (switching cycles)	5×10^7
N° of switching cycles at 0.5 A / 125 V AC	1×10^5
N° of switching cycles at 1 A / 30 V DC	1×10^5

Output 4

Relay with changeover contact

Switching voltage	max. 125 V AC / 110 V DC
Switching current	max. 1 A AC / 1 A DC min. 1 mA AC/DC
Switching capacity	max. 62.5 VA / 30 W
Mech. service life (switching cycles)	5×10^7
N° of switching cycles at 1 A / 110 V AC	1×10^5
N° of switching cycles at 1 A / 30 V DC	1×10^5

Reaction time of the outputs, Relay

< 7 ms
(only impulse and time counter)

Max. count frequency

50 kHz

Operating temperature

-20 °C ... +55 °C
[-4 °F ... +131 °F]

Additional technical data Codix 924-6

Output 1 ... 6

NPN optocouplers

Switching capacity	30 V DC / 10 mA
U_{CESAT} at IC = 10 mA	max. 2.0 V
U_{CESAT} at IC = 5 mA	max. 0.4 V

output 3, 4, 5 and 6 with common emitter

Reaction time of the outputs, optocouplers

(only impulse and time counter)

Add/Sub/	< 1 ms
with auto repeat	< 1 ms
A/B; (A-B)/A	< 23 ms

Max. count frequency

50 kHz

Preset counters, electronic

LCD preset counters **Multifunctional – pulse, frequency, time – 1...6 presets (AC+DC)** **Codix 923 / 924**

Terminal assignment

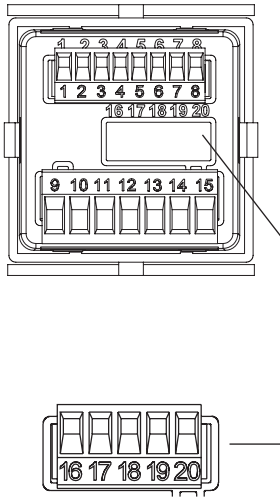

Pin	Signal and control inputs
1	Sensor supply voltage AC: 24 V DC / 80 mA DC: U_B interconnected
2	GND (0 V DC)
3	INP A (Signal input A)
4	INP B (Signal input B)
5	RESET (Reset input)
6	LOCK (Key locking input)
7	GATE (Gate input)
8	MPI (User input)

Pin	Version with relays/optocouplers
9	Relay contact C. / Collector
10	Relay contact N.O. / Emitter
11	Relay contact C. / Emitter
12	Relay contact N.O. / not assigned
13	Relay contact N.C. / Collector
14	AC: 24 V AC, 100 ... 240 VAC, $\pm 10\%$ N- DC: 10 ... 30 V DC
15	AC: 24 V AC, 100 ... 240 VAC, $\pm 10\%$ L- DC: GND (0 VDC)

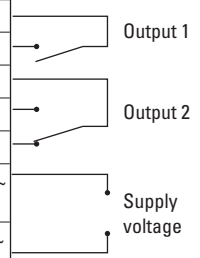

Pin	Additional connections 924-4
16	Relay contact N.C.4 output 4
17	Relay contact C.4 output 4
18	Relay contact N.O.4 output 4
19	Relay contact N.O.3 output 3
20	Relay contact C.3 output 3

Pin	Additional connections 924-6
16	Common-Emitter output 3 to 6
17	Collector 6 output 6
18	Collector 5 output 5
19	Collector 4 output 4
20	Collector 3 output 3

Dimensions

Dimensions in mm [inch]

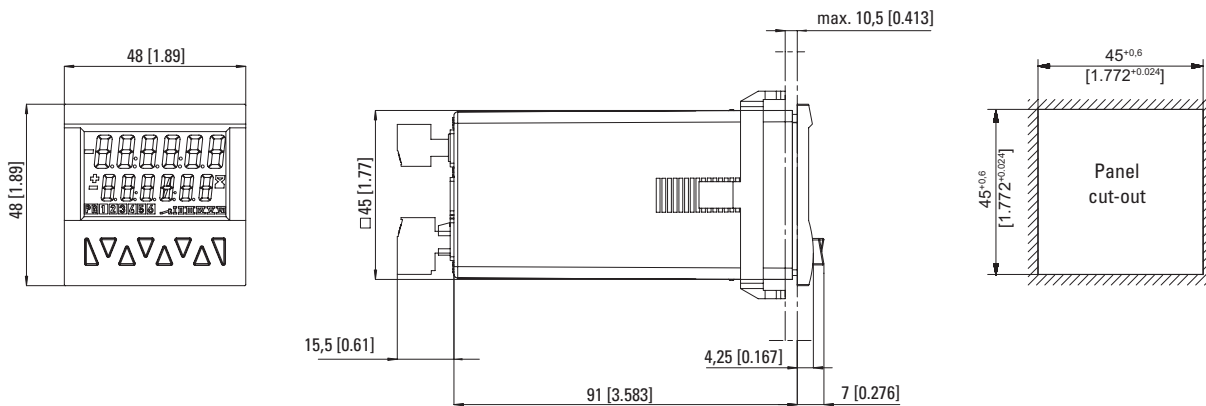

Preset counters, electronic

LCD preset counters

Multifunctional – pulse, frequency, time – 1...6 presets (AC+DC)

Codix 923 / 924

Pulse counter

Functions / count modes:

- Count with direction mode
- Difference mode
- Quadrature mode quad/quad2/quad4
- Add, Sub, automatic reset
- 2-input adding mode A+B
- Ratio measurement A/B
- Percentage difference measurement $(A-B)/A \times 100 \%$
- Batch counting
- Totalizer (overall total)
- Multiplication and division factor (up to 99.9999)
- Set value
- Step or tracking preset

Application examples

CountDir + Add

Roller shutter door with automatic shut-off

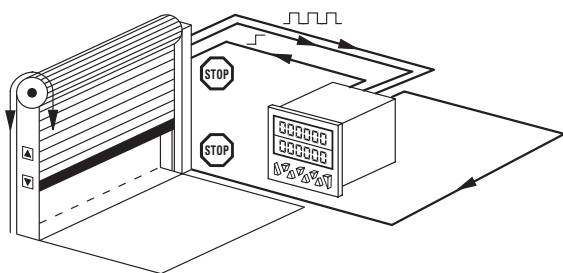

Quad + Add

Running direction and position on milling machines, Limit switch monitoring

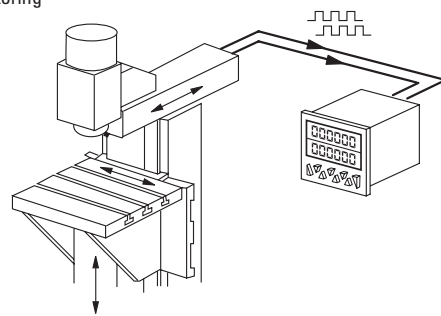

UpDown + Add

Automatic subtraction of faulty or reject parts from the total piece count

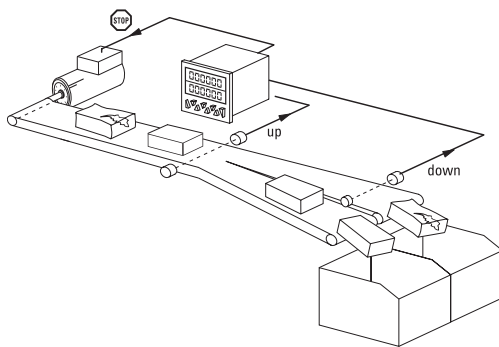

CountDir + Batch

Logging of piece numbers and packing units plus control of replenishment of packing cartons

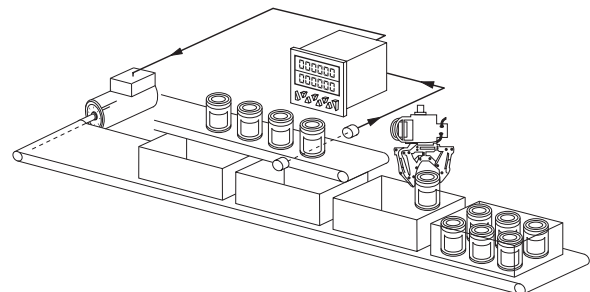

UpUp + Add

Adding up of two parallel or staggered production lines

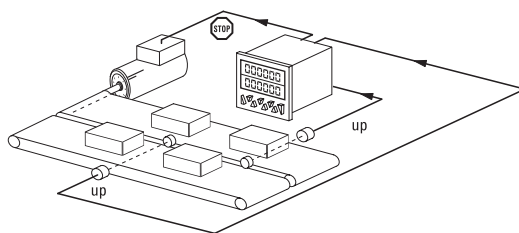

Quad + Add tot

Cut-to-length with overall total count and control of the machine

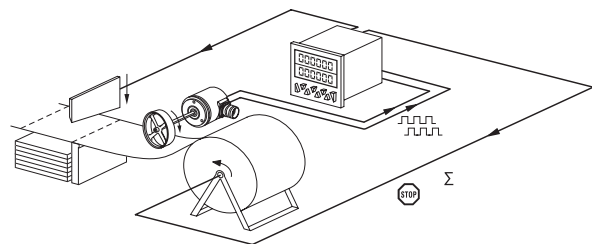

Preset counters, electronic

LCD preset counters **Multifunctional – pulse, frequency, time – 1...6 presets (AC+DC)** **Codix 923 / 924**

Frequency meter (tachometer)

Functions / count modes:

- A
- A – B
- A + B
- A / B
- $(A - B) / A \times 100\%$ (percentage display)
- Quad (phase discriminator with recognition of direction)
- Averaging
- Start delay
- 2nd tacho input
- Gate input
- Multiplication and division factor (up to 99.9999)

Application examples

A – B

Synchro monitoring and control of two conveyor belts

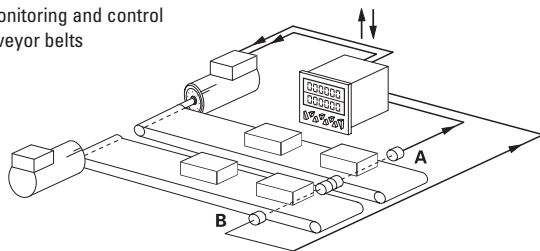

Quad

Speed regulation with indication of direction

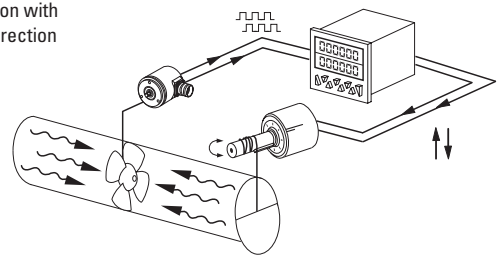

A/B

Ratio measurement

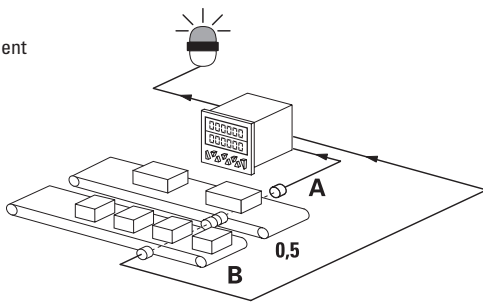

$(A-B)/A$ [%]

Ratio measurement, e.g. for speed alignment

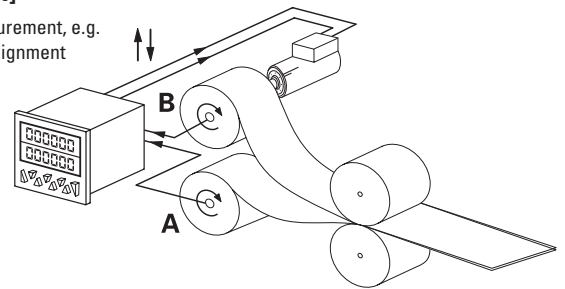

Time and Hours-run meter (timer)

Functions / count modes:

- FrErUn (control via gate input)
- Auto (start via reset, stop at preset)
- InpB.InpB (start with first edge at InpB., stop with second edge InpB.)
- InpA. InpB (start with InpA., stop with InpB.)
- Totalizer (overall total)
- Batch counting
- Set value
- Step or tracking preset

Application examples

InpB. InpB

Interval measurement

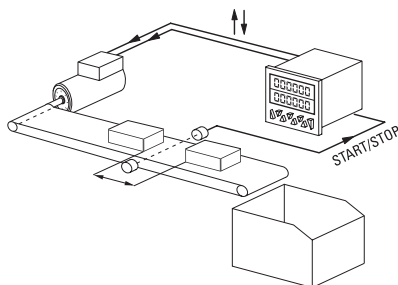

FrErUn

Measurement of overall time from switching on the conveyor belt till switching off

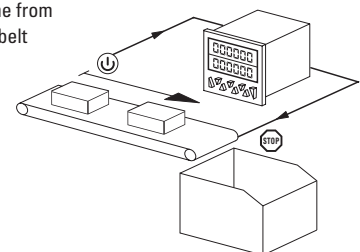

InpA. InpB

Run-time measurement

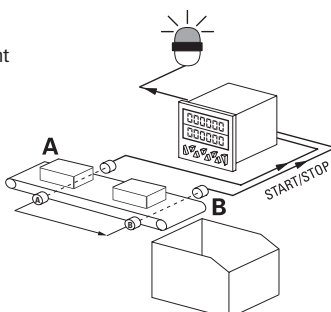

Auto

Time-controlled production line

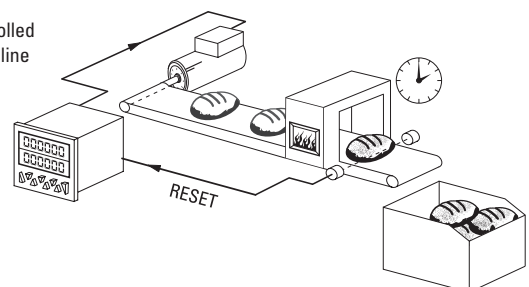

Preset counters, electronic

LCD preset counters Multifunctional – pulse, frequency, time – 1...6 presets (AC+DC) Codix 923 / 924

Expandable hardware

Expandable on request via modules:

- 4 additional inputs
- Or 4 additional optocoupler outputs
- Or 2 additional relay outputs
- Or RS232/485 communications interfaces

Application examples

- Limit switch monitoring
- Special functions/PLC function
- Initiation of fixed program sequences
- Control of several processes
- Special protocols
- Print commands for logging

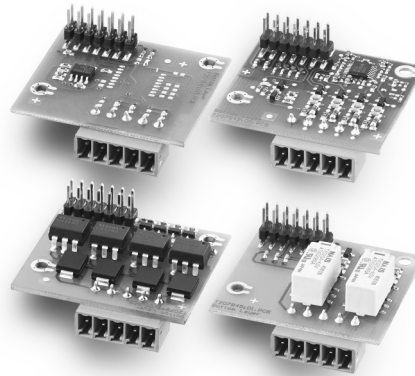

Customizable software

Individual customization of software to your application.

For example:

- Separate inputs for total counter and preset counter
- Separate scaling of input A and B
- Programmable measuring period for the tachometer
- Measurement of rotary speeds based on time
- Processing time, measurement of time based on frequency
- With the Multicolor version, the display color changes when reaching the preset, or blinking display with all versions

