

# User's manual

## POWER FACTOR REGULATORS

PFC *max*6 / PFC *max*12

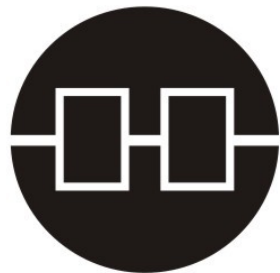
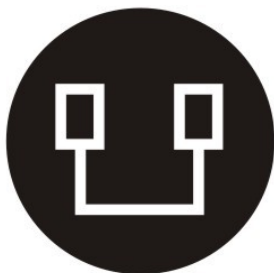

# Index

<b>1. INTRODUCTION AND SAFETY RECOMMENDATIONS</b> .....	4
1.1 Delivery spot check.....	5
1.2 Starting screen.....	5
1.3 Definitions.....	5
1.3.1 Four quadrant regulators .....	6
1.3.2 FCP program (FAST PFCized Program) .....	6
1.3.3 Stages and steps.....	6
1.3.4 Stages ratio program .....	6
<b>2. GENERAL CHARACTERISTICS</b> .....	7
<b>3. FRONT PANEL: SCREEN and KEYBOARD</b> .....	8
3.1 Display screen .....	9
3.2 Measured parameters .....	9
3.3 Errors and ERROR messages .....	9
3.4 Alarm relay.....	10
3.5 Regulator status and key functions .....	10
PFC max regulators have two possible status. ....	10
3.5.1 Key functions in normal RUN status .....	11
3.5.2 Key functions in SET-UP status.....	11
<b>4. INSTALLATION AND START UP</b> .....	12
4.1 Technical Characteristics .....	12
4.2 DEVICE INSTALLATION .....	13
4.2.1 Mechanical Installation .....	13
4.2.2 Connections .....	13
4.2.3 Cabling cross sections and protections.....	14

4.2.4	Schematics .....	15
<b>5.</b>	<b>CONFIGURABLE PARAMETERS .....</b>	<b>16</b>
5.1	Target $\cos\phi$ .....	16
5.2	Smaller available capacitor step.....	16
5.3	C/K parameter calculation .....	17
5.4	Stage's Configuration of PF correction equipment (Configuration program) .....	17
5.5	Connection and re-connection time settings:.....	18
5.6	Selection of the number of stages .....	18
5.7	V,I phase angle setting.....	18
5.8	Programming the CT rated current (primary).....	19
<b>6.</b>	<b>SET-UP MENU AND PROCEDURE .....</b>	<b>19</b>
6.1	How to access the set-up menu .....	19
6.2	Navigation schematic.....	20
<b>7.</b>	<b>RUN STATUS .....</b>	<b>21</b>
7.1	Functions of the device in normal RUN mode .....	21
7.2	PFC max behaviour in ALARM mode.....	22
<b>8.</b>	<b>MAINTENANCE .....</b>	<b>22</b>

## INTRODUCTION AND SAFETY RECOMMENDATIONS



Iskra would like to thank you for showing your trust by choosing one of our **PFC max** series regulators. These units are constructed with the latest state-of-the-art technology, including a powerful processor to calculate the optimum algorithms for achieving the best compensation of  $\cos\phi$ .

The units comply with the Electrical Safety Standard EN 61010, in accordance with the requirements of the Low Voltage Directive (LVD) 73/23/EC and EMC Directive (2004/108/EC) and, therefore, they are certified to carry the CE mark.



This user manual describes the operation of the **PFC max** series regulators and shows the user the procedures required to install, commission and operate the units.

### SAFETY

 <b>CAUTION!</b>	<p>The installation and maintenance of the unit must be performed by duly trained and authorised staff and in accordance with the national and international standards. Any inappropriate manipulation or use of this equipment out of the conditions specified by the manufacturer may involve serious dangers to the user.</p>
 <b>DANGER!</b>	<p>Before performing any maintenance operation on the PFC and associated PF compensation equipment, be sure to disconnect the main switch. After disconnecting the switch, wait at least 5 minutes to ensure that the capacitors are totally discharged.</p>

During the installation, maintenance or commissioning of equipment regulated by a **PFC max** unit, the following safety precautions must be observed:

- ✓ Before connecting the equipment make sure that the earth terminals have been properly connected. A defective earth connection may cause a wrong operation of equipment and involves a danger of electric shock to the user or system operator.
- ✓ Maintenance must be performed taking the necessary precautions to avoid electrocution and electric shock. Ensure that the unit has been disconnected and wait the necessary time to ensure that the capacitors are totally discharged before any maintenance action. We recommend the use of safety goggles and gloves when cabinet doors are open and protection covers removed.
- ✓ If a PF compensation unit is connected to mains and capacitors are accidentally connected without load, a resonance may occur. In such condition voltage harmonics may be amplified, cause overvoltage and damage the compensation unit and other equipment connected to the mains.
- ✓ The start-up and interruption procedures indicated in the manual must be followed to avoid damaging the PF equipment and/or other equipment connected to mains.

- ✓ The adjustment or replacement of components or parts of the unit must be made with original replacement parts and in accordance with the procedures described in the corresponding instruction manual.

## 1.1 Delivery spot check

After unpacking the equipment check the following points:

- Check that equipment has not suffered any damage during transport.
- The equipment corresponds to type you ordered. (See label at the rear face, fig. 1.1)
- Check that the characteristics in the label are suitable for the site where the regulator has to be installed. (Supply voltage and frequency, measuring range, etc.)
- Follow the instructions in section 3 for installation and set-up.
- If you may observe any anomaly during the installation or set-up, contact with Iskra, technical service.

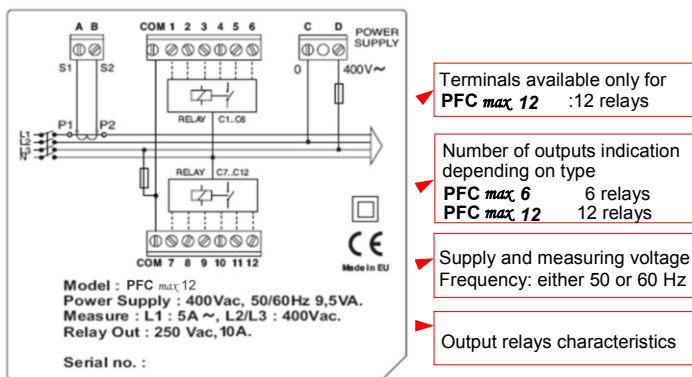

Fig. 0.1.- Rear face label

- ▶ Terminals available only for **PFC *max* 12** :12 relays
- ▶ Number of outputs indication depending on type  
**PFC *max* 6** 6 relays  
**PFC *max* 12** 12 relays
- ▶ Supply and measuring voltage  
 Frequency: either 50 or 60 Hz
- ▶ Output relays characteristics

## 1.2 Starting screen



When the PFC *max* is started (just after supply connection) the screen shows a code indicating the device version. It's important to indicate this code in case of reporting any device fault or error.

## 1.3 Definitions

In this section we shall give several definitions which will be useful to understand several sections of this manual.

### 1.3.1 Four quadrant regulators

This term is used to describe the regulators which are able to perform measure and control, either if the active power flows from the utility to the customer network (the common case of a consuming facility) or if it flows in the reverse sense. The later is the case of facilities containing power generation equipment which export some amount of generated power to the utility.

### 1.3.2 FCP program (FAST PFCized Program)

The units having FCP program, control the switching of capacitor stages in order to minimize the number of switching operations to reach the required PF compensation. Moreover, the program assigns the capacitor stages to be connected or disconnected using a FIFO criterion (FIFO= First IN, first OUT), that way the times of use of all stages are equalized.

### 1.3.3 Stages and steps

We must distinguish between these two terms. In this manual we call STAGE to each of the capacitor groups that constitute the PF correction unit. The capacitor stages in PF correction equipment may have all the same power or not, as explained in the following paragraphs.

The term STEP is used to describe the minimum fraction of reactive power in which the PF correction equipment is divided. Usually this is the power of the lower stage.

### 1.3.4 Stages ratio program

Powers of successive capacitor stages in PF correction equipment generally follow certain patterns called stages ratio program or simply "Program". The stages program indicates the relationship between the different capacitor stage powers. Most common stages ratio programs are the as follows:

**Program 1:1:1.** All capacitor stages have the same rated power (kvar). For instance, a 5-stage unit of 100 kvar would be formed by 5 equal stages of 20 kvar and would be described as a unit of (5 x 20) kvar.

**Program 1:2:2.** All capacitor stages from the second and up have a rated power (kvar) which is twice the rated power of first stage. For instance, a 5-stage unit of 180 kvar would be formed by a first stage of 20 kvar and 4 equal stages of 40 kvar, and would be described as a unit of (20 + 4 x 40) kvar.

**Program 1:2:4.** The rated power of the second stage is twice the rated power of the first stage and the rated power of third stage and up is 4 times the power of the first stage. For instance, a 5-stage unit of 300 kvar would be formed by a first stage of 20 kvar, a second stage of 40 kvar and 3 equal stages of 80 kvar, and would be described as a unit of (20 + 40 + 3 x 80) kvar.

**Other switching programs.** Other switching programs are also commonly available, like 1:2:2:4 or 1:1:2:2, etc. Abbreviated designation form, as can be deduced from previous cases, consists of a sequence of numbers giving the relationship between the different stage powers (kvar), and the first stage power, which value is taken as unit (1). The successive stages will be designated by 1, or 2 or 4, etc. meaning that the kvar ratio of such stages with regard to first stage are equal, twice, four times, etc.

## 2. GENERAL CHARACTERISTICS

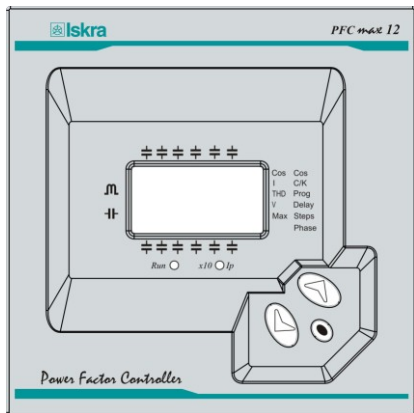

The power factor regulators, of types PFC *max6* and *max 12* measure the  $\cos\phi$  (sometimes called Displacement Power Factor, DPF) in a supply network and control the connection and disconnection of power capacitors in order to regulate such parameter.

The difference between the two types is the number of output relays, which determines the number of stages that they can control.

Type	Maximum Nr. of output relays
PFC <i>max6</i>	6 relay outputs
PFC <i>max12</i>	12 relay outputs

Among the most important features of this PF regulator series we can stand out the following:

- FCP regulation system, which minimizes the number of switching operations.
- Wide choice of switching programs: 1:1:1, 1:2:2, 1:2:4 , 1:1:2:2, etc. which allows the split up of the total power into up to 31 steps in *max6* or up to 79 steps in *max12*
- Four quadrants control (see fig.2.1) , display of the connected stages, of  $\cos\phi$  and active and reactive power signs (inductive  $\sim$  or capacitive  $\dashv$ )
- LCD display screen with three seven segments characters plus 20 icons to sign up the different possible working conditions.
- Regulator set-up with only three keys and without disconnecting the device from the supply.
- Multiple supply frequency range, either 50 or 60Hz
- Main electrical parameters displayed during RUN mode
- Easy panel mounting, without the need of tools.
- Front frame size (144 x 144 mm) according to DIN 43 700 (panel hole  $138^{+1} \times 138^{+1}$  mm)
- Measurement and power supply in one single input.
- Four quadrant regulation (suitable for installations importing or exporting energy)

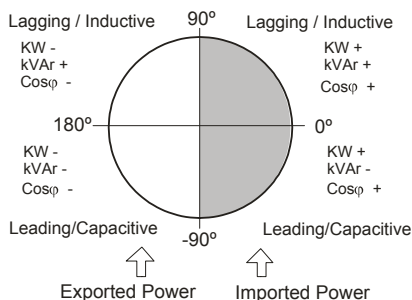

Fig. 2.1.- Power signs in four quadrants measurements

### 3. FRONT PANEL: SCREEN and KEYBOARD

The PF regulator's front panel shows the following items:

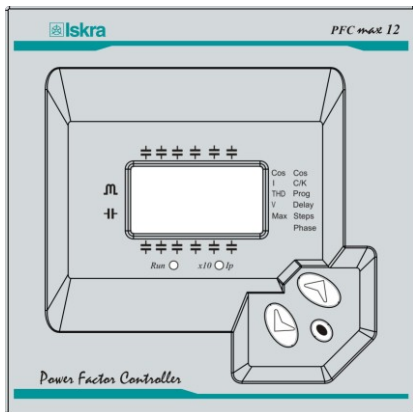

Fig. 3.1.- Front cover and screen

**NOTE:** The set-up procedure, the description of different parameters and the different control modes are described in detail in the SET-UP section (section 6)

**Front Screen**

**Configurable Parameters**

Cos  
C/K  
Prog  
Delay  
Steps  
Phase

$x10 \bigcirc Ip$

**Measured Parameters**

▷ Cos  
▶ I  
▷ THD  
▷ V  
▷ Max

**Navigation keys**



### 3.1 Display screen

**PFC max** devices are equipped with a 3 digits x 7 segments LCD screen. The screen has also a set of icons, which provide information about the regulator status. The main indications are:  $\cos\phi$  value, reactive power sign ( $\sim$  for lagging or inductive PF and  $-$  for leading or capacitive PF), connected stages and measurement of different parameters (see section 3.2)

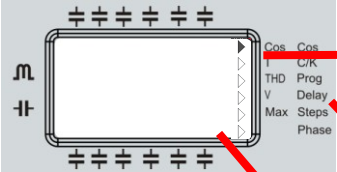
Icons	Screen and LED	Icons Indications
<p><math>\sim</math> : Lagging or inductive power indication</p> <p><math>-</math> : Leading or capacitive power indication</p> <p>The RUN LED (red) is ON in normal working conditions</p> <p>The <math>\boxed{x10 \otimes Ip}</math> LED shows that the reading of current or max. current has to be multiplied by 10</p>		<p>In normal working conditions, RUN LED (red) is ON and <math>\blacktriangleright</math> cursor points to the parameter being displayed (Left column list)</p> <p>In SET-UP mode, the RUN LED is OFF, the <math>\blacktriangleright</math> cursor is blinking and pointing to the parameter being configured (Right column list).</p> <p>Symbols indicating the stages which are connected (only in RUN mode)</p>



### 3.2 Measured parameters



When the instrument is in normal RUN mode, the following parameters can be displayed:  $\cos\phi$ , mains current, THD of both mains current and mains voltage. The instrument can also display the maximum values of mains current and voltage since the last parameters clear. The parameter being displayed can be selected with the navigation keys and is indicated by the  $\blacktriangleright$  cursor.

### 3.3 Errors and ERROR messages

In case that the regulator detects a possible error, the front screen shows an error code. The possible error codes are listed and explained in table 3-1.

Table 3-1: Possible errors and messages displayed on the screen

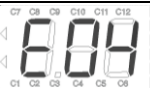
ERROR message	Description
	<p>Load current below the threshold current, or current transformer (CT) not connected. The threshold is 0,1A at the secondary side of CT</p>
	<p>Overcompensation. The regulator detects that some stages should be disconnected but all the stages are already disconnected.</p>

	Under-compensation. The regulator detects that some stages should be connected and all the stages are already connected.
	Overcurrent. The measured current exceeds the rated current by a + 20%. (Rated current is considered to be the CT primary rated current)
	Overvoltage. The measured voltage exceeds the rated voltage by a +15%.

### 3.4 Alarm relay

In case that the number of stages configured in a **PFC max6** or **max12**, is less than 6 or 12 respectively, the relay number 6 or 12 is automatically configured as alarm relay. The relay remains connected in absence of alarm (positive safety) and disconnects in case that one or more of the errors listed in section 3.2 occur. Notice that the absence of supply voltage will always be detected as an alarm condition. The alarm relay has a delay of 10s in case of Over-compensation and Under-compensation, but the operation is instantaneous (delay < 1s) in case of Over-voltage and Over-current.

### 3.5 Regulator status and key functions



PFC max regulators have two possible status.

**Normal or RUN Status:** This is the normal working status of the regulator. In such status the device measures and displays the  $\cos\phi$  of the loads and automatically regulates the connection and disconnection of capacitors in order to compensate according to programmed target value. The regulation depends on several parameters configured during the starting set-up process.

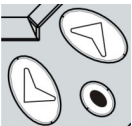

**Set-up or adjustment status:** This status allows the configuration of the device. Push the key  for a time >1s to enter the set-up status mode. This will stop the automatic PF regulation, will cause the progressive disconnection of connected stages and once disconnected will allow the set-up of the regulator.

	The navigation keys have different functions depending on the regulator status.
--	---

### 3.5.1 Key functions in normal RUN status

	<p><b>Key to enter set-up mode:</b> After a long push (<math>&gt; 1s</math>) of this key, the device will enter the set-up mode, and will accept configuration changes.</p>
	<p><b>Manual connection of capacitor stages:</b> If this key is pushed for more than 1s, the regulator starts connecting new steps in a sequential mode, respecting the adjusted connection times, <math>t_{on}</math></p>
	<p><b>Manual disconnection of capacitor stages:</b> If this key is pushed for more than 1s, the regulator starts disconnecting steps in a sequential mode, respecting the adjusted disconnection times, <math>t_{off}</math></p>

### 3.5.2 Key functions in SET-UP status

	<p><b>Long Push (<math>&gt;1s</math>):</b> This is to initiate or exit the set-up mode. Exiting the set-up mode with a long push (<math>&gt;1s</math>) will automatically save the changed parameters. Exiting with a short push will not save the changes.</p> <p><b>Long Push (<math>&lt;1s</math>):</b> This is used to initiate or exit the different set-up sub-menu options (different configurable parameters). <b>Warning!</b> The new programmed values are not saved unless a long push of this key (<math>&gt;1s</math>) is used to exit the set-up menu.</p>
	<p>Upwards navigation in the menu options available in the set-up menu. Increment of numerical values inside the set-up sub-menus.</p>
	<p>Downwards navigation in the menu options available in the set-up menu. Decrement of numerical values inside the set-up sub-menus. Change the digit to be edited in case of numerical values with more than one digit.</p>

## 4. INSTALLATION AND START UP

This section contains information instructions and warnings that the user must follow by its own security and to ensure safe operation of the device.



**WARNING!** PFC *max* regulators are usually connected to equipment containing capacitors, which remain charged after removing supply voltage. To avoid risk of electric shock, you must **wait at least 5 minutes between the disconnection of the equipment and handling of the internal components** thereof.

**Any handling or use of equipment in different way or conditions to that specified by the manufacturer, may compromise the user safety.**

In case that some damage or deterioration signs are detected in the device or a wrong operation is observed, disconnect the supply voltage and contact Iskra authorized technical service.

To safely use the PFC *max6* and PFC *max12* it is important that people installing it or handling it follow the usual safety precautions stated in the LV or MV Electrical Code Rules of each Country as well as the different warnings stated in this instruction manual.

### 4.1 Technical Characteristics

The main technical characteristics of every particular PFC *max6* and PFC *max12* device are printed in the rear label (see fig. 1.2) and are also summarized in the following table.

<b>Supply and measuring circuit voltage (Terminals C-D)</b>	480, 400, 230 o 110 VCA ; +15% -10% ; 45-65 Hz , (see label) Connect preferably to phases L2-L3.
<b>Supply Cables</b>	Cross Section 1,5mm <sup>2</sup>
<b>Supply circuit protection</b>	By means of a 0,5 to 2 A fuse (gl type)
<b>Current measurement circuit. (Terminals A-B)</b>	External Current Transformer (CT). Current ratio In /5. To be placed preferably in phase L1.
<b>Cables for the current measurement circuit (CT secondary side)</b>	Minimum cross section : 2,5mm <sup>2</sup> . If cable length between regulator and CT must exceed 25m, increase the cross section by 1mm <sup>2</sup> every 10m or use a CT with a higher primary rated current.
<b>Current margin</b>	0,1 to 5 A (maximum overload +20%)
<b>Measurements precision</b>	Voltage and Current: 1%; cosφ: 2% ± 1 digit
<b>cosφ setting margin</b>	0,85 ind. A 0,85 cap. Default setting: 1
<b>Power Consumption</b>	6 VA (all relays OFF) ; 9,5VA (12 relays ON)
<b>Screen</b>	1 line x 3 digits x 7segments + 20 icons
<b>Output: Relay contacts</b>	Working voltage: 250 VCA, Admissible current: 10 A, AC1.
<b>Cabling and protection of relays output.</b>	Minimum cables cross section: 1,5mm <sup>2</sup> , Protect by means of a circuit breaker 6A, curve C or fuse 6A, gl type
<b>Alarm relay</b>	In case that not all the relay outputs are used to drive the capacitors, the highest number relay is by default configured as alarm relay.
<b>Reference standards</b>	EN 61010, EN 61000-3-2, EN 61000-3-3, EN 50081-2, EN 50082-1, EN 50082-2, EN 61000-4-2, EN 61000-4-4, EN 61000-4-8, EN 61000-4-5, EN 61000-4-11, UL 94
<b>Safety and Insulation class</b>	Installation Category III. Protection against electrical shock with double insulation (class II), according to EN 61010-1

<b>Protection degree</b>	IP51 (device mounted in panel front) IP30 (device case) according to EN-60529
<b>Environment admissible conditions</b>	Temperature: -20°C a +60°C; Relative humidity: max. 95% (without condensation). Max. altitude: 2000m
<b>Control system</b>	FCP (Program which minimizes the number of operations)

## 4.2 DEVICE INSTALLATION

### 4.2.1 Mechanical Installation

Mechanically, the device is intended to be mounted attached to the front door of the cabinet. The fitting hole must be according to DIN 43 700, (dimensions 138<sup>+1</sup>x138<sup>+1</sup>mm).

### 4.2.2 Connections

Before connecting the supply to the device check the following items:

	<p>The installation and maintenance of the device must be carried out by specialised and dully trained staff, according to National Electric Codes and Rules and International Standards</p>
	<p>All the connections must be at the inner part of a protection cabinet.</p>
	<p>Notice that when the device is connected to supply, the <b>voltage at certain terminals can be hazardous and cause electric shock</b> in case of contact. Opening the electrical cabinet or removing certain covers can compromise the user safety and should only be done by qualified and authorized staff.</p>

The **PFC max** devices are used together with capacitor banks, which can remain charged after supply disconnection. In order to avoid shock hazard, wait during 5 minutes after supply disconnection before any manipulation inside the equipment cabinet.

**PFC max** devices require current sensing of the installation. A current transformer (CT) must be installed externally to perform this function. Usually the current ratio of the CT is **In / 5 A**, where **In** must be at least 1,5 times the maximum expected load current.

The CT must be installed at the incoming supply line (point of coupling of the user), so that it measures the total current of all the loads, including also the compensation capacitor bank (see fig. 4.1) The CT should be installed preferably in phase L1, while the voltage measuring terminals of **PFC max** should be connected to phases L2 and L3 (see schematics in figs. 4.2 and 4.3). It's important to respect the connection senses of P1-P2 and S1-S2 shown in the above mentioned figs, otherwise the phase difference will have to be corrected by adjusting the device according to set-up procedure indicated in paragraph 5.1.7.

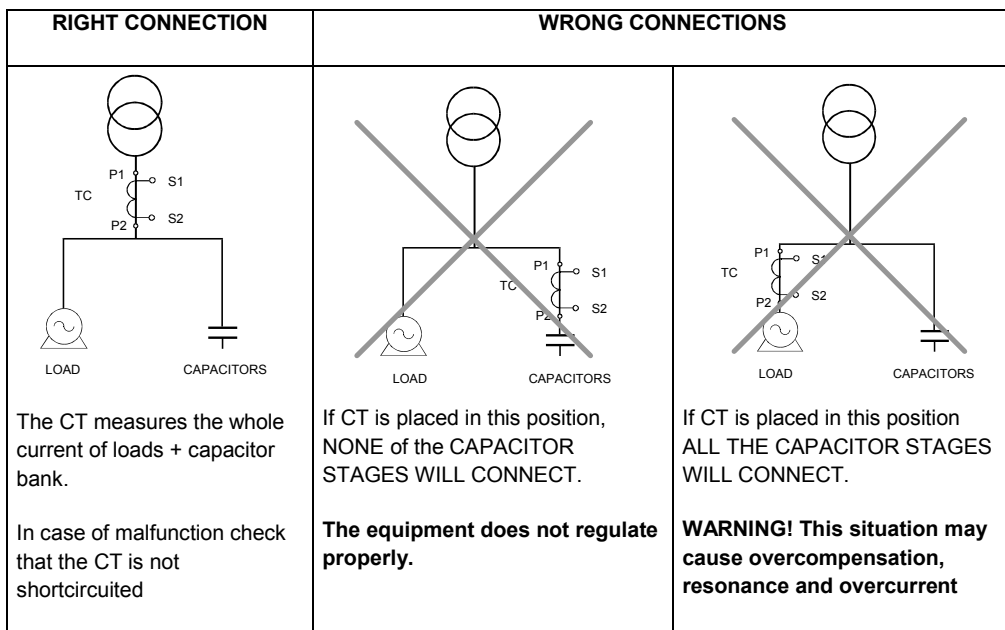

Fig. 4.1.- Placement of current transformer (CT)

### 4.2.3 Cabling cross sections and protections

The supply circuit must be protected by means of fuses or a circuit breaker sized between 0,5 and 2A. Recommended fuses are gl type (IEC 269) or M type (IEC 127). A main circuit breaker must be provided in order to allow the disconnection of control circuits from supply (PFC, relays, contactor coils, etc.)

The main switch must be easily accessible. The cabling cross section must be minimum 1,5 mm<sup>2</sup> for the voltage supply and for the relay outputs and 2,5 mm<sup>2</sup> for the cables connecting secondary of CT to PFC *max*. For distances between CT and PFC higher than 10m the cross section of the last must be increased at a rate of 1 extra mm<sup>2</sup> every 10 m.

4.2.4 Schematics

**PFC max6**

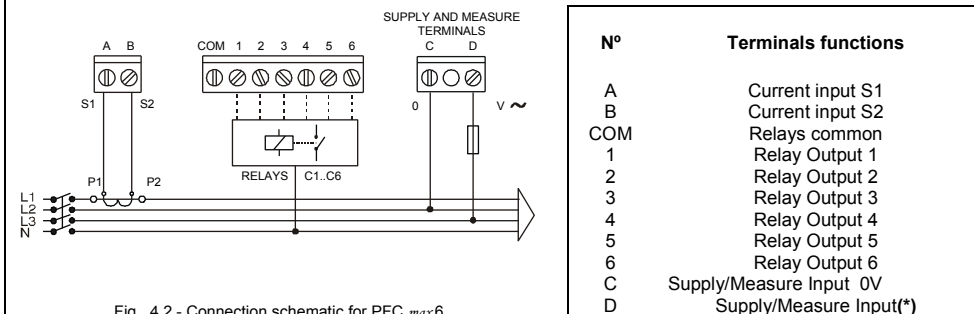

Fig. 4.2.- Connection schematic for PFC max6

(\*) Rated voltage depending on type. See device label

**PFC max12**

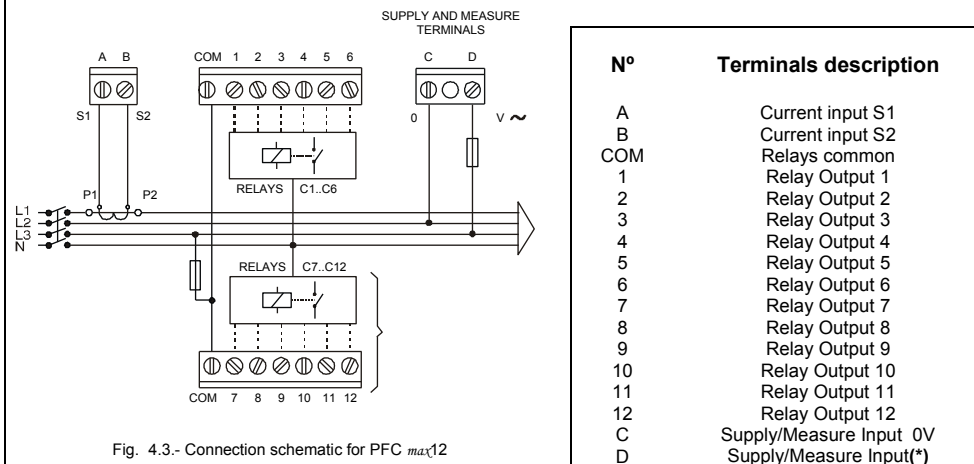

Fig. 4.3.- Connection schematic for PFC max12

(\*) Rated voltage depending on type. See device label





**WARNING!** For PFC max12 devices (12 relay outputs) the connection between COM terminals in the upper and lower terminal strips must be done externally.

## 5. CONFIGURABLE PARAMETERS

In order to adapt the regulator to the loads, certain parameters of the PFC  $max$  must be set-up. The programmable parameters, the required settings and the set-up procedure are explained here below. See also paragraph 3.5.2 to see how to select the different menu options.





The configurable parameters are listed and shortly explained below.

### 5.1 Target $\cos\phi$

To set-up this parameter, use the keys   until the cursor  points to the option **Cos** , then push 

The parameter allows the setting of the desired PF in the installation. The regulator will control the connection of the necessary number of capacitors to get the maximum approach to the target value. Since the regulation is in a stepwise mode, the regulator will add a new step when the demanded power is at least 70% of the lower available step power and will remove a step when the excess is also a 70% of the lower available step power. The  $\cos\phi$  adjustment range is from 0,85 inductive to 0,95 capacitive.

### 5.2 Smaller available capacitor step

To set-up this parameter, use the keys   until the cursor  points to the option **C/K** , then push 

This parameter, named C/K, indicates the reactive current supplied by the smaller capacitor step, measured at the secondary side of the current transformer (CT). Therefore, the setting value depends on the power of the smaller capacitor step, on the CT ratio and on the supply voltage. Table 5.1 gives the setting values of C/K for a 400 V phase to phase supply for different CT ratios and different values of smaller capacitor step (kvar). For conditions other than those given in table 5.1, the paragraph 5.1.3 shows a simple calculation to obtain the C/K value. See also foot NOTE.

Table 5-1.- C/K factor according to smaller capacitor power and CT ratio.

CT ratio ( $I_p/I_s$ )	Smaller capacitor power in kvar, at 400V (*)														
	2,5	5,00	7,5	10,0	12,5	15,0	20,0	25,0	30,0	37,5	40,0	50,0	60,0	75,0	80,0
150/5	0,12	0,24	0,36	0,48	0,60	0,72	0,96								
200/5	0,09	0,18	0,27	0,36	0,45	0,54	0,72	0,90							
250/5	0,07	0,14	0,22	0,29	0,36	0,43	0,58	0,72	0,87						
300/5	0,06	0,12	0,18	0,24	0,30	0,36	0,48	0,60	0,72	0,90	0,96				
400/5	0,05	0,09	0,14	0,18	0,23	0,24	0,36	0,48	0,58	0,67	0,72	0,87			
500/5		0,07	0,11	0,14	0,18	0,22	0,29	0,36	0,45	0,54	0,54	0,72	0,87		
600/5		0,06	0,09	0,12	0,15	0,18	0,24	0,30	0,36	0,45	0,48	0,60	0,72	0,90	0,96
800/5			0,07	0,09	0,11	0,14	0,18	0,23	0,27	0,33	0,36	0,45	0,54	0,68	0,72
1000/5			0,05	0,07	0,09	0,11	0,14	0,18	0,22	0,27	0,29	0,36	0,43	0,54	0,57
1500/5				0,05	0,06	0,07	0,10	0,12	0,14	0,18	0,19	0,24	0,29	0,36	0,38
2000/5						0,05	0,07	0,09	0,11	0,13	0,14	0,18	0,22	0,27	0,28
2500/5							0,06	0,07	0,09	0,10	0,12	0,14	0,17	0,22	0,23
3000/5							0,05	0,06	0,07	0,09	0,10	0,12	0,14	0,18	0,19
4000/5									0,05	0,06	0,07	0,09	0,11	0,14	0,14

(\*) NOTE: For supply voltages other than 400V the C/K factor obtained from the table must be multiplied by the ratio  $(400 / V_{supply})$



**IMPORTANT! :**

If C/K is adjusted too low the system will connect and disconnect steps with a lower threshold and therefore the number of operations to control the average PF will be higher.

If C/K is adjusted slightly above the required value (10%) the system will react with higher threshold values and therefore the number of operations to control the average PF will be lower. Wear of PF compensation is also lower.

**5.3 C/K parameter calculation**

For conditions other than those given in table 5.1 the parameter C/K can be calculated as follows.

The necessary data to perform the calculation are: The power of the smaller capacitor step,  $Q$ , the supply voltage,  $V$  and the current transformer ratio,  $K$  ;  $K = I_{prim}/I_{sec}$ .

Where:  $I_{prim}$  is the CT primary rated current (i.e. in a 250/5 CT , the primary rated current is 250 A)

$I_{sec}$  is the CT secondary rated current , usually 5 A

Then, the smaller step reactive current,  $I_C$ , can be calculated as:  $I_C = \frac{Q}{\sqrt{3} \cdot V}$

and the C/K parameter would be  $C/K = \frac{I_C}{K} = \frac{Q}{\sqrt{3} \cdot K \cdot V}$





**Example:** Assume a PF equipment at 500V where the smaller capacitor is rated to 60kvar and the CT has a ratio 500/5. The calculation would be as follows:

K ratio  $K = 500/5 = 100$

Smaller capacitor current  $I_C = \frac{60.1000}{\sqrt{3} \cdot 500} = 9,28A$

C/K parameter  $C/K = \frac{I_C}{K} = \frac{9,28}{100} = 0,0928$

**5.4 Stage's Configuration of PF correction equipment (Configuration program)**

To set-up this parameter, use the keys   until the cursor  points to the option **Prog** , then push 

PF correction equipment is constituted by several capacitor stages, which may have different power ratings. Taking as base the power of the smaller capacitor stage, the powers of the rest of stages can be given in terms of multiples of the smaller step. Then we could state the configuration (configuration program) of PF equipment as:

Program 1:1:1... All the stages have the same power in kvar.





Program 1:2:2... The second stage and successive have a power double than the 1st step.

The available programs of PFC max regulator are listed in table 5.2. The default factory setting of PFC max devices is 1:1:1:1

Table 5-2.- Available configuration programs for PFC *max* devices





Screen Indication	Stage's configuration
111	1:1:1:1:1....
122	1:2:2:2:2....
124	1:2:4:4:4....
248	1:2:4:8:8....
112	1:1:2:2:2....

### 5.5 Connection and re-connection time settings:

To set-up this parameter, use the keys   until the cursor  points to the option **Delay** , then push  .





This parameter sets up the delay times of the device. The setting value, Tc, is the delay time between the connection or disconnection of successive capacitor stages. The parameter also sets up the called re-connection delay, Tr, which is the minimum time that must elapse between the disconnection of a C stage and its following connection. The range of Tc settings goes from 4s to 999s. Tr is automatically set to 5 times Tc (Notice that Tr is needed to guarantee the capacitors discharge). **The default setting of Tc is 10s.**

### 5.6 Selection of the number of stages

To set-up this parameter, use the keys   until the cursor  points to the option **Steps** , then push  .

This setting allows the selection of the number of stages of the PF compensation equipment. Depending on the device type, PFC *max6* ó *max12* we can select up to 6 or 12 stages. If the number of stages is less than 6 or 12 respectively in PFC *max6* or *max12* the relay number 6 or 12 is automatically assigned as alarm relay (see paragraph 3.3)

### 5.7 V,I phase angle setting

To set-up this parameter, use the keys   until the cursor  points to the option **Phase** , then push  .



During the set-up of this parameter, the screen shows alternatively one of the options T1 to T6 and the  $\cos\varphi$ .

This parameter permits the adaptation of the regulator to different options of connection of voltage and current measurement in the three phase system. The default assumed connection is the one shown in figs. 4.2 and 4.3, i.e., the current transformer placed in phase L1 and voltage measurement between phases L2 (terminal C) and L3 (terminal D). Sometimes it's difficult to guarantee this connection or even check how it is. To adapt to this unknown situations the PFC *max* devices allow the selection of different options, T1 to T6, as shown in table 5.3. To select the right option during start up, you should verify that there is load and that the loads are mainly inductive with a  $\cos\varphi$  between 0,7 y 1. In this situation try the different options until the  $\cos\varphi$  screen shows a value between 0,7 and 1.

Table 5-3.- Phase shift options in PFC *max*





Screen	V-I phase shift at $\cos \varphi = 1$	V measured in phases	CT placed in phase
T1	30°	L3-L2	L3
T2	270°	L3-L2	L1
T3	150°	L3-L2	L2
T4	210°	L3-L2	L3 (P1-P2 or S1-S2 reversed)
T5	90°	L3-L2	L1 (P1-P2 or S1-S2 reversed)
T6	330°	L3-L2	L2 (P1-P2 or S1-S2 reversed)

## 5.8 Programming the CT rated current (primary)

The set-up of this parameter can be selected at the bottom of the menu options. Use the   keys until the bottom red LED  $\times 10 \bigcirc I_p$  is flashing and push . The display will show the assumed CT primary current. Set the value according to the CT used to measure installation current. The adjustment range is from 0 to 999 and with the  $\times 10$  option allows a rated primary current up to 9990 A. By default the secondary of CT is assumed to be 5 A.

## 6. SET-UP MENU AND PROCEDURE

### 6.1 How to access the set-up menu

To access the set-up menu, press the key  for more than 1s (This is designated as long push in table 6.1, which gives a summary of the set-up procedure). The pointer  starts blinking and points to the parameter to be adjusted. Select the parameter by means of the keys  .

After the long push and in case that all the capacitor stages are disconnected, the device jumps to the set-up status. In case that there are some stages connected, keep the key  pushed while the regulator disconnects the connected stages sequentially and respecting the programmed delay time. Once all the stages have been disconnected the device enters the set-up status and allows the adjustment of the different parameters. A schematic diagram of the set-up menu showing the different navigation paths is shown in table 6.1. The meanings of the different adjustable parameters have been explained in paragraph 5.1.

## 6.2 Navigation schematic

Parameter selection	Device screen display		See paragraph
<p> <b>Long push to start set-up</b></p> <p>Target cos <math>\phi</math> Starting screen</p>	<p>Long Push</p> <p>RUN Measurement</p>	<p>Short Push</p> <p>Target cos <math>\phi</math></p>	<p>Increase</p> <p>Next digit</p> <p>5.1.1</p>
<p> C/K</p>	<p>Long Push</p> <p>RUN Measurement</p>	<p>Short Push</p> <p>C/K setting</p>	<p>Increase</p> <p>Next digit</p> <p>5.1.2</p> <p>5.1.3</p>
<p> Program</p>	<p>Long Push</p> <p>RUN Measurement</p>	<p>Short Push</p> <p>Program setting</p>	<p>Prog change</p> <p>5.1.4</p>
<p> Delay times</p>	<p>Long Push</p> <p>RUN Measurement</p>	<p>Short Push</p> <p>Delay setting</p>	<p>Increase</p> <p>Next digit</p> <p>5.1.5</p>
<p> Nr of stages</p>	<p>Long Push</p> <p>RUN Measurement</p>	<p>Short Push</p> <p>Nr steps setting</p>	<p>Increase</p> <p>Next digit</p> <p>5.1.6</p>
<p> CT phase</p>	<p>Long Push</p> <p>RUN Measurement</p>	<p>Short Push</p> <p>CT phase setting</p>	<p>Phase change</p> <p>5.1.7</p>
<p> CT primary current</p>	<p>Long Push</p> <p>RUN Measurement</p>	<p>Short Push</p> <p>CT primary current setting</p>	<p>Increase</p> <p>Next digit</p> <p>5.1.8</p>

**! IMPORTANT! :**

While the device is in set-up mode, if there isn't any key pushing for more than 3 minutes, the device returns automatically to normal RUN mode and none of the previously edited parameters are changed nor saved. **To exit the set-up menu changing the edited parameters, push the key for more than 1s.**









## 7. RUN STATUS

Once the device has been configured according to installation needs it can be set to RUN mode to regulate the PF of the installation. RUN mode is the default mode after exiting the set-up menu or after the device start (supply connection followed by a short initialisation period). When the device is in RUN mode it can reach one of the following status:

- a) **Normal RUN status (Absence of alarm):** In this status the device performs the automatic PF regulation, connecting and disconnecting the capacitor stages according to installation needs. In this status the user can access to the measurement of different parameters and can also force the manual connection or disconnection of capacitor stages as described in paragraph 7.1.
- b) **Alarm status:** If any of the anomalous situations described in paragraph 3.2 occur, the device jumps to alarm status and displays the error code. Depending on the error type the regulator may perform the disconnection of all the stages or continue regulating the PF as in normal RUN.

### 7.1 Functions of the device in normal RUN mode





In the normal RUN mode the PFC max can perform the following functions:

 long	<b>Manual connection of capacitor stages.</b> Keep the key pushed during more than 1s and the regulator will sequentially connect the different steps, following the normal program and respecting the delay time $t_{on}$ set in the set-up procedure.
 long	<b>Manual disconnection of capacitor stages:</b> Keep the key pushed during more than 1s and the regulator will sequentially disconnect the different steps, following the normal program and respecting the delay time $t_{off}$ set in the set-up procedure.
 	<b>Displaying the number of connected steps:</b> If both keys are simultaneously pushed the device displays the Nr of connected steps. (Remember the difference between step and stage described in paragraph 1.1).
 short	<b>Parameters measurement:</b> Performing successive short pushing of this key (<1s), the user can travel along several display screens showing the values of the following parameters: (cos) , cosinus $\varphi$ of the installation ; (I) , mains current; (THD), THD of mains current; (V) , Mains voltage; (I, MAX), Maximum value of mains current since the last clear; (V MAX), Maximum value of mains voltage since the last clear. The displayed parameter is pointed by the cursor ►.
 short	<b>Parameters measurement:</b> Performing successive short pushing of this key (<1s), the user can travel through the readings of the same parameters described above but in reverse order.
 long	<b>Start the SET-UP mode:</b> Performing a long push of this key (<1s), the device jumps to set-up mode.
 ► MAX	<b>Clear MAX values:</b> Performing a long push of this key (<1s) while the cursor ► is pointing to MAX , the PFC $max\chi$ clears the maximum values of voltage and current recorded since the last clear.

## 7.2 PFC *max* behaviour in ALARM mode

In case that the PFC max detects an error during normal operation (see paragraph 3.2) the screen displays an error code and the behaviour of the device is as described in table 7-1.

Table 7-1.- Phase shift options in PFC *max*

	<b>Measured current below threshold</b> (0,1 <sup>a</sup> measured at the secondary side of CT)	<b>Possible causes:</b> Baja carga o TC no conectado. El aparato muestra el LED de RUN y la pantalla con todo ceros parpadeando y no conecta ningún relé
	<b>Over-compensation.</b> The controller demands for stages disconnection and they are all disconnected.	<b>Possible causes:</b> C/K not properly adjusted None of the realys will connect.
	<b>Sub-compensation.</b> The controller demands for stages connection and they are all connected.	<b>Possible causes:</b> C/K not properly adjusted All the relays will remain connected, except the alarm relay if exists (see paragraph 3.3)
	<b>Overcurrent.</b> The measured current is 20% above the rated current (primary of CT)	<b>Possible causes:</b> C/K not properly adjusted Alarm relay, if exists, disconnects (see paragraph 3.3) Although the regulation may be wrong, the device tries to regulate the PF normally.
	<b>Overvoltage.</b> The measured voltage is 15% above rated voltage.	<b>Possible causes:</b> Connection to a wrong supply voltage. Alarm relay, if exists, disconnects (see paragraph 3.3) Although the regulation may be wrong, the device tries to regulate the PF normally.

## 8. MAINTENANCE

The PFC *max* 6 and *max* 12 do not require a special maintenance program. In case that some adjustments or maintenance might be necessary it must be performed by dully qualified staff and respecting the required safety procedures.

If any malfunction of the PF compensation equipment or associated protections is detected, the equipment should be disconnected from mains. Before performing any maintenance repair or update operation on the PFC or associated PF compensation equipment, be sure to disconnect the main switch and after disconnecting the switch, wait at least 5 minutes to ensure that the capacitors are totally discharged.

**Iskra MIS, d. d.**  
Ljubljanska cesta 24a  
4000 Kranj, Slovenia  
Phone.: +386 4 237 21 12  
Fax: + 386 4 237 21 29  
E-mail: [info@iskra-mis.si](mailto:info@iskra-mis.si)  
[www.iskra-mis.si](http://www.iskra-mis.si)