

## DX<sup>3</sup> Signalling Biconnect Auxiliary Contact (CA and SD)

Cat. N°(s): 4 062 50, 52, 56, 64

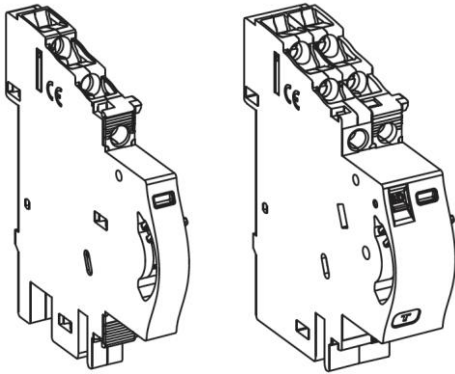

CONTENTS	PAGE
1. Description - Use .....	1
2. Range .....	1
3. Overall dimensions .....	1
4. Preparation - Connection .....	2
5. General Characteristics .....	3
6. Compliance and approvals.....	4

### 1. DESCRIPTION - USE

. Auxiliary contact (CA): Changeover switch indicates contacts position (open or closed) of the associated device (circuit breaker or switch, differential or not).

Fault signalling contact (SD): Changeover switch indicates fault tripping of the associated device (circuit breaker or switch, differential or not).

#### Symbol:



### 2. RANGE

- . Cat. n° 4 062 50 : auxiliary changeover switch (CA).
- . Cat. n° 4 062 52 : fault signalling changeover switch (SD).
- . Cat. n° 4 062 56 : auxiliary changeover switch (CA) modifiable into a fault signalling changeover switch (SD).
- . Cat. n° 4 062 64 : auxiliary changeover switch (CA) + fault signalling changeover switch (SD) modifiable into 2 auxiliary changeover switch (2CA).

### 3. OVERALL DIMENSIONS

. 0,5 module width: Cat. n°(s) 4 062 50, 52, 56.

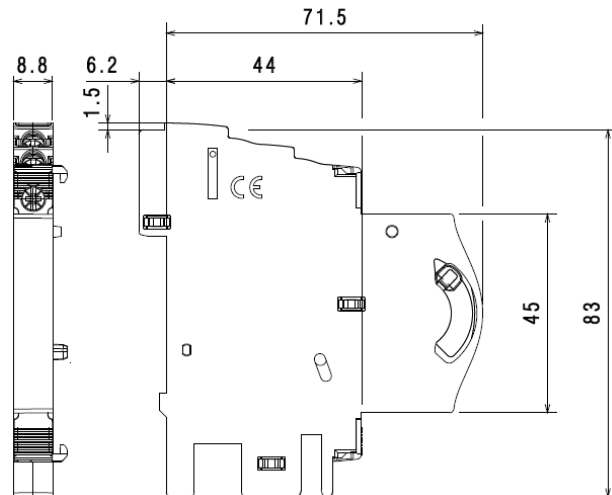

. 1 modules width: Cat. N° 4 062 64.

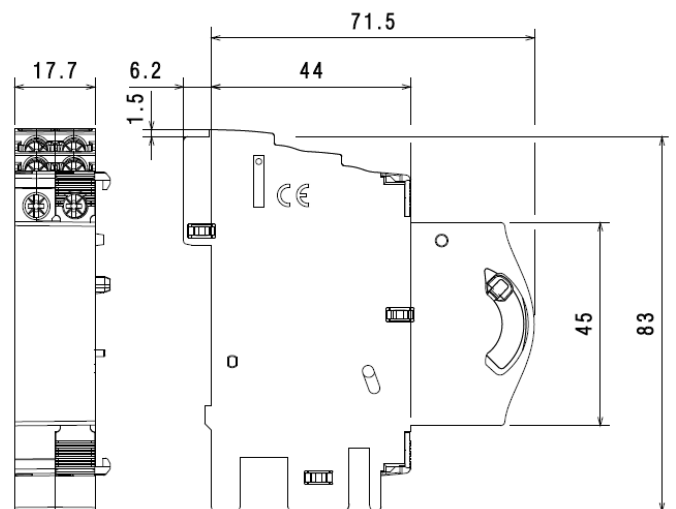

## 4. PREPARATION -CONNECTION

### Fixing:

- . On symmetric rail EN/IEC 60715 or DIN 35 rail, by the device which is associated.

### Operating positions:

- . Vertical, Horizontal, Upside down, On the side



### Power Supply:

- . Only from the bottom.

### Terminals:

- . Terminal depth: 8 mm.
- . Stripping length: 8 mm

### Screw head:

- . Mixed, slotted and Pozidriv n°1 (UNI7596 type Z1).

### Recommended tightening torque:

- . 1 Nm.

### Recommended tools:

- . For the terminals: Pozidriv n°1 or flat screwdriver 4 mm.
- . For the CA/SD selector: flat screwdriver 4mm.

### Conductor type:

	Copper cable	
	Without ferrule	With ferrule
Rigid Cable	1 x 0,5 mm <sup>2</sup> to 1,5 mm <sup>2</sup> 2 x 1,5 mm <sup>2</sup>	-
Flexible Cable	1 x 0,5 mm <sup>2</sup> to 1,5 mm <sup>2</sup> 2 x 1,5 mm <sup>2</sup>	1 x 0,5 mm <sup>2</sup> to 1,5 mm <sup>2</sup> 2 x 1,5 mm <sup>2</sup>

### Manual action of the CA or SD:

- . By the handle of the associated device.

### Visualization:

- . By mechanical indicator on front face.
- . Cat. n°(s) 4 062 50, 56 and 64 with the selector in "CA" position:
  - Red : indicates that the contacts position of the device (MCB, IS, RCCBO, RCCB) which the auxiliary is associated.
  - Transparent : indicates the ON position of the contacts of the associate device (MCB, IS, RCCBO, RCCB) which the auxiliary is associated.
- . Cat. n°(s) 4 062 52, 56 and 64 with the selector in "SD" position:
  - Red: indicates that the associated device (MCB, RDC, RCCB) which the auxiliary is associated, has tripped on fault (overload, short-circuit, differential default) or tripping by control auxiliary "MT" or "DA".
  - transparent : indicates that the associated device ((MCB, IS, RCCBO, RCCB) which the auxiliary is associated, has the contacts closed (ON) or open (OFF) by a manual operation on the associated device.

## 4. PREPARATION -CONNECTION (continued)

### CA/SD Selector:

- . On the auxiliaries cat n°(s) 4 062 56, 64, the selector allows to turn a contact in a "CA" or "SD" contact. The selector can be operated with a 3,5 to 4 mm flat screwdriver.

### Assembling:

- . On the left side of Legrand MCB, IS, RCCBO or RCCB
- . No tools are required. Clipped by mean of plastic clamps on the associated device.
- . Assembling products in OFF position
- . The switching device of signalling auxiliaries must fit into the housing of the handle of the associated device.

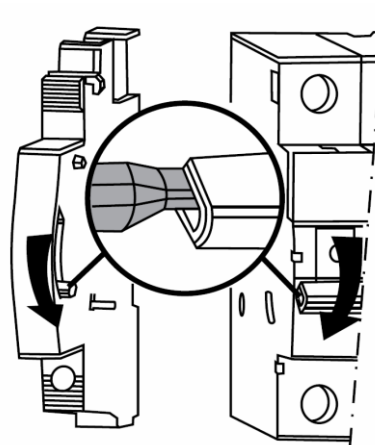

### List of allowed associations (General rules):

- . Three auxiliaries maximum which:
  - two signalling auxiliaries (Cat. n°(s) 4 062 50, 52, 56, 64).
  - Only one control auxiliary (Cat. n°(s) 4 062 76, 78, 80, 82, 84).
- . If signalling and control auxiliaries are associated on the same circuit breaker, the command auxiliary must be placed to the left of the signal auxiliary (ref. 4 062 5x / 6x).
- . For devices 1,5 modules per pole width:
  - If a Remote tripping auxiliary is already mounted on this kind of device, current shunt trips (4 062 76/78), under-voltage releases (4 062 80/82, autonomous shunt trip for N/C push-button (4 062 87) or power overvoltage protection (POP) (4 062 86) then only 1 module signalling auxiliaries can be added (auxiliary + fault signalling contact or auxiliary contact + auxiliary contact 4 062 64). In this set up the ½ module signalling auxiliaries will not operate.
  - Nothing changes for the other modular references.
- . List of allowed associations (Particular rules):
  - . With an isolating switch DX-IS:
    - only one signalling auxiliary CA type (Cat. n°(s) 4 062 50, 64).
  - . With a remote trip head isolating switch DX-IS, three auxiliaries maximum which:
    - one or two signalling auxiliaries CA type (Cat. n°(s) 4 062 50, 64).
    - one control auxiliary cat n°(s) 4 062 7x / 8x.
  - . With a MCB, IS, RCBO, RCCB three auxiliaries maximum which:
    - one or two signalling auxiliaries, CA or SD type (Cat. n°(s) 4 062 50, 52, 56, 64).
    - one control auxiliary Cat. n°(s) 4 062 7x / 8x.





# DX<sup>3</sup> Signalling Biconnect Auxiliary Contact (CA and SD)

Cat. N°(s): 4 062 50, 52, 56, 64

## 4. PREPARATION –CONNECTION (continued)

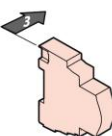
### Combination tables of the auxiliaries:

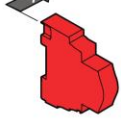
. For devices 1 module per pole width:

			
			17.5 mm
		4 062 .. 50 / 52 / 56 / 58 / 60 / 62 / 66 / 76 / 78 / 80 / 82 / 84 / 86 / 87	
	4 062 .. 50 / 52 / 56 / 58 / 60 / 62 / 76 / 78 / 80 / 82 / 84 / 86 / 87	4 062 .. 50 / 52 / 56 / 58 / 60 / 62	
	4 062 .. 50 / 52 / 56 / 58 / 60 / 62 / 64 / 66 / 76 / 78 / 80 / 82 / 84 / 86 / 87	4 062 .. 64 / 66	
4 062 .. 76 / 78 / 80 / 82 / 84 / 86 / 87	4 062 .. 50 / 52 / 56 / 58 / 60 / 62	4 062 .. 50 / 52 / 56 / 58 / 60 / 62	
	4 062 .. 50 / 52 / 56 / 58 / 60 / 62 / 64 / 66	4 062 .. 64 / 66	

. For devices 1,5 modules per pole width:

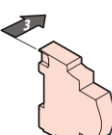
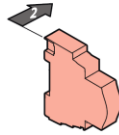
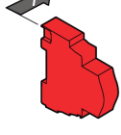
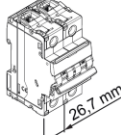
			
			26.7 mm
		4 062 .. 50 / 52 / 56 / 58 / 60 / 62 / 66 / 76 / 78 / 80 / 82 / 84 / 86 / 87	
	4 062 .. 50 / 52 / 56 / 58 / 60 / 62	4 062 .. 50 / 52 / 56 / 58 / 60 / 62	
	4 062 .. 50 / 52 / 56 / 58 / 60 / 62 / 64 / 66 / 76 / 78 / 80 / 82 / 84 / 86 / 87	4 062 .. 64 / 66	
4 062 .. 76 / 78 / 80 / 82 / 84 / 86 / 87	4 062 .. 64 / 66	4 062 .. 64 / 66	

### Wiring diagrams:

. CA.

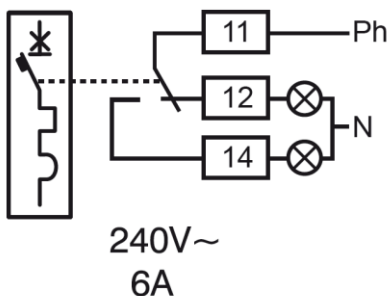

. (terminals marking on the 2<sup>nd</sup> CA are 21 / 22 / 24 when the selector of the reference 4 062 64 is in the "CA" position).

## 4. PREPARATION –CONNECTION (continued)

### Wiring diagrams: (continued)

. SD.

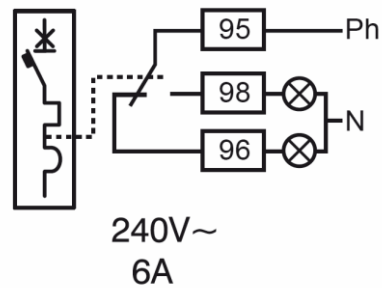



## 5. GENERAL CHARACTERISTICS

### Front side marking:

. By permanent ink pad printing:

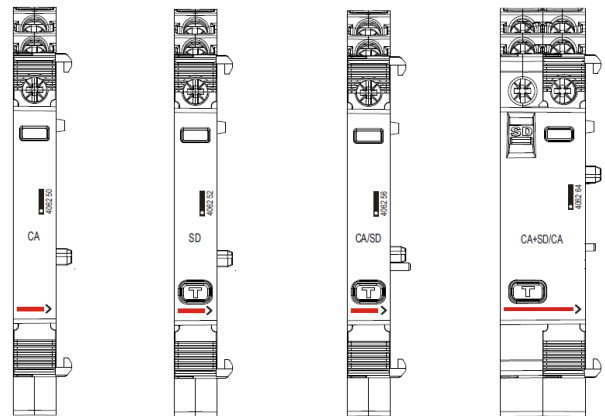
cat n° 4 062 50    cat n° 4 062 52    cat n° 4 062 56    cat n° 4 062 64



- Function name :  
CA = auxiliary changeover switch  
SD = fault signalling changeover switch.
- Function selector CA or SD (moulded on the selector)
- Legrand reference code and Logo .

### Rated current I<sub>n</sub>:

. 6A

### Rated voltage:

. 240V~

### Operating range:

. From 5V d.c. and 1 mA min to 230V and 0,5 A maxi in d.c.

. From 5V a.c. and 1 mA min to 400V and 3 A maxi in a.c.

Un in a.c.	5 V to 60 V	110 / 230 V	400 V
I maxi	<b>10 A</b>	<b>6 A</b>	<b>3 A</b>

Un in d.c.	12 / 24 V	48 / 60 V	110 / 230 V
I maxi	<b>4 A</b>	<b>1 A</b>	<b>0,5 A</b>

## 5. GENERAL CHARACTERISTICS *(continued)*

### Thermal current:

. I<sub>the</sub> = 10A.

### Short circuit withstand:

. I<sub>cw</sub> 1000A.

### Held in short-circuit:

. Equivalent to the breaking capacity in accordance with standards IEC/EN 60947-2 and IEC/EN 60898 of the Legrand circuit breaker that protects the auxiliary contact

### Rated impulse withstand voltage:

. U<sub>imp</sub> = 5kV.

### Electromagnetic compatibility:

. Burst: 4 kV.

. Surge 1,2 / 50 μs : 4 kV differential mode et 5 kV common mode

### Insulation voltage:

. U<sub>i</sub> = 500 V

### Dielectric strength:

. 2500 V.

### Tripping force:

. Between 1 and 1,5 Nm.

### Mechanical endurance:

. These devices support the mechanical cycles of the associated devices

. 20,000 manoeuvres without load..

. 10,000 manoeuvres with load AC12 category according to the standard IEC 60947-5-1.

### Ambient temperatures:

. Operation: from -25°C. to +70°C

. Storage: from -40°C. to +70°C

### Enclosure material:

. Polycarbonate charged 10% glass fiber.

. Characteristics of this material: self extinguishing, heat and fire resistant according to EN 60898-1, glow-wire test at 960°C for external parts made of insulating material necessary to retain in position current-carrying parts and parts of protective circuit (650°C for all other external parts made of insulating material).

### Degree of class protection:

. Protection index of terminals against solid and liquid bodies: IP20 (in accordance with standards IEC 529, EN 60529 and NF C 20-010).

. Protection index of the box against solid and liquid bodies: IP40 (in accordance with standards IEC 529, EN 60529 and NF C 20-010).

. Protection index against mechanical shocks: IK02 (in accordance with standard EN 50102 and NF C 20-015).

## 5. GENERAL CHARACTERISTICS *(continued)*

### Sinusoidal vibration resistance in accordance with IEC 60068-2-6:

. Axes : x, y, z.

. Frequency: 5÷100 Hz ; duration 90 minutes

. Displacement (5÷13,2 Hz) : 1mm

. Acceleration (13,2÷100 Hz) : 0,7g (g=9,81 m/s<sup>2</sup>)

### Average weight per device:

Cat. N°	Weight (kg)
4 062 50, 52, 56	0,034
4 062 64	0,060

### Volume when packed:

. 0,21 dm<sup>3</sup>

### Power dissipated (W) :

. 0 W.

## 6. COMPLIANCE AND APPROVALS

### In accordance with:

. Standards EN 60947-5-1, EN 60439-1 (Low Voltage Directive 2006/95/EC), EN 60439-3 (Directive EMC 2004/108/EC) and EN 62019.

. CEE guidelines : 73/23/CEE + 93/68/CEE

### Plastic materials :

. Halogens-free plastic materials.

. Marking of parts according to ISO 11469 and ISO 1043.

### Packaging:

. Design and manufacture of packaging in accordance with Decree 98-638 of 07.20.98 and Directive 94/62/EC