

Plug ProTOP - Part no. 152A

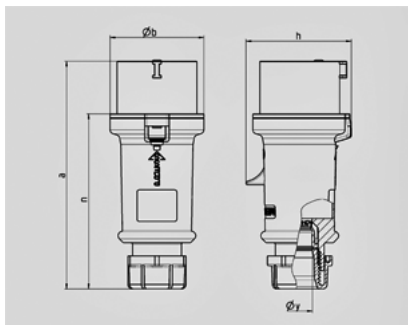

- screw terminals
- cable gland and sealing
- strain relief and protection against kinking
- enclosure with thread lock and safety slide

Technical information	
Ampere	16 A
Poles	4 p
Voltage	400 V
Earth position	6 h
Hertz	50-60 Hz
Connection technology	Screw terminals
Contact	standard
Protection type	IP 44



Drawing 2 MB 214	Amp. Poles	16			32		
		3	4	5	3	4	5
Dim. in mm	a	148	160	160	197	197	197
	b	55	65,6	65,6	75	75	75
	h	61	72,5	72,5	80,5	80,5	85
	n	112	123,5	123,5	152	152	152
	y	14,5	16	16	22	22	22
Terminal for cond. cross		1	1	1	2,5	2,5	2,5
section (mm ²) min.-max.		—2,5	—2,5	—2,5	—6	—6	—6