

Karta katalogowa | Numer produktu: 2000-410

mostek grzebieniowy; z izolacją; 10-tor.; prąd nominalny 14 A; jasnoszary

www.wago.com/2000-410



Data

Dane elektryczne

Parametry znamionowe zgodnie z IEC/EN 60664-1

napięcie znamionowe (III / 3)	800 V
prąd znamionowy	14 A

Zmiany zastrzeżone

WAGO ELWAG sp. z o. o.
ul. Piękna 58 a
50-506 Wrocław
Tel.: +48 71 3602972 | Fax: +48 71 3602999
Email: wago.elwag@wago.com

Masz pytania dotyczące naszych produktów?
Jesteśmy do Twojej dyspozycji pod numerem telefonu +48 71 360 29 70.



Approvals Ex

prąd znamionowy (Ex e II)	12 A
---------------------------	------

Wymiary

szerokość	34 mm / 1.339 inch
wysokość	19 mm / 0.748 inch
głębokość	4,1 mm / 0.161 inch

Dane materiałowe

kolor	jasnoszary
obciążenie ogniowe	0,023 MJ
masa	2,9 g

Dane handlowe

Grupa produktów	22 (TOPJOB S)
rodzaju opakowania	bag
Kraj pochodzenia	DE
GTIN	4055143697057
Nr taryfy celnej	85366990990

Wskazówki dotyczące obsługi

Jumpered

Zmiany zastrzeżone

WAGO ELWAG sp. z o. o.
ul. Piękna 58 a
50-506 Wrocław
Tel.: +48 71 3602972 | Fax: +48 71 3602999
Email: wago.elwag@wago.com

Masz pytania dotyczące naszych produktów?
Jesteśmy do Twojej dyspozycji pod numerem telefonu +48 71 360 29 70.

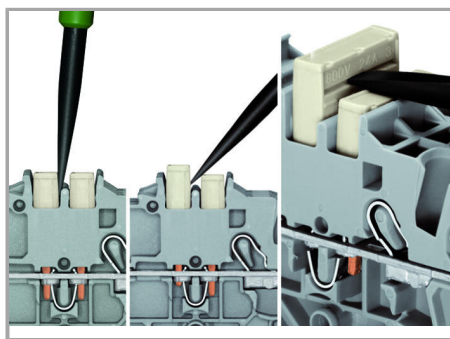
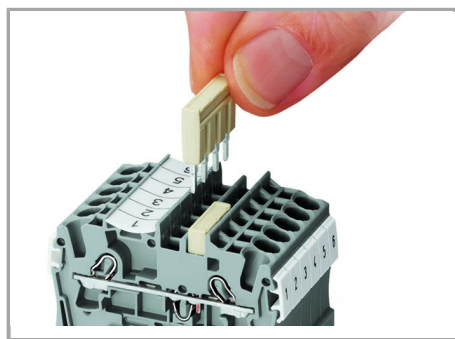

The push-in type jumper bar system is based on the common plug and socket principle. Each terminal block is spring-loaded with a double socket and a resilient CrNi steel spring. The jumper contact material is pure electrolytic copper, which allows for an extremely small design capable of carrying the full-rated current of the terminal block. Ground terminal blocks can also be commoned using the same jumper system. Custom jumpers are created by breaking and removing jumper contacts (2000, 2001, 2002, 2004 Series).

Removing a push-in type jumper bar.

Insert the operating tool between the jumper and the partition wall of the dual jumper slots, then lift up the jumper.

Place the operating tool in the center of jumpers up to five contacts (see above), or alternately on both sides for jumpers with more than five contacts.

Jumpered

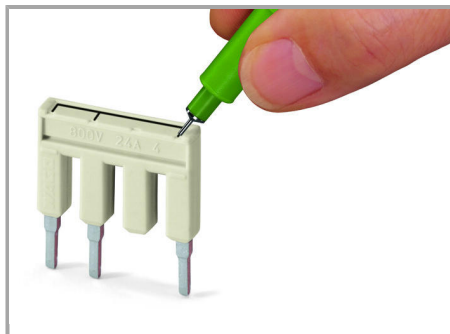
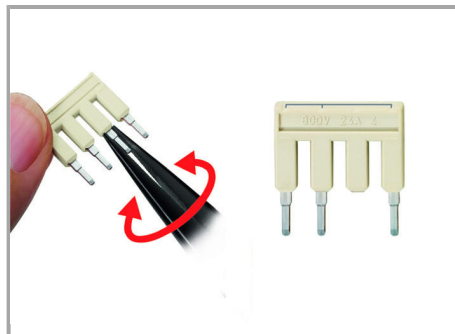

Custom push-in type jumper bars are created by breaking off jumper contacts.

Marking a push-in type jumper bar using a felt-tip pen.

500 V

300 V

Zmiany zastrzeżone

Jumpered

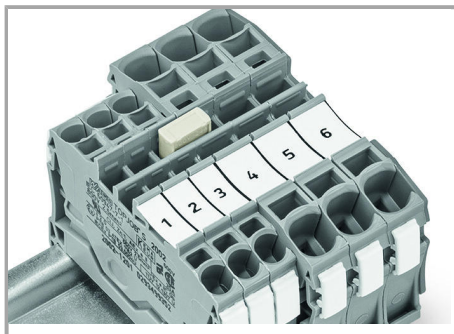

Stepping down via push-in type jumper bar.

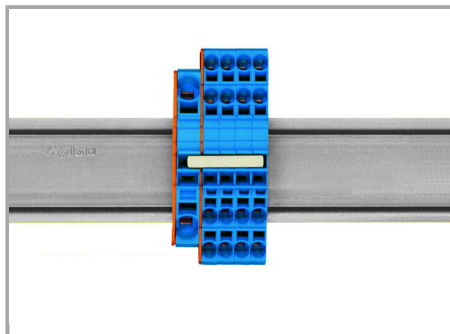

Stepping down via push-in type jumper bar.

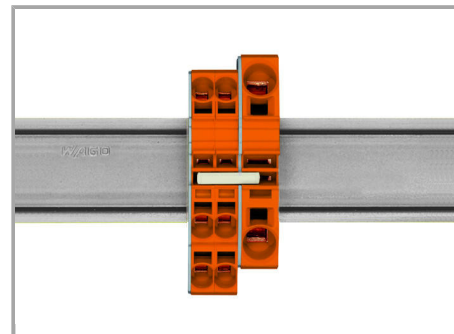

Stepping down via push-in type jumper bar.

Commoning via closed terminal side with end plate allows jumpering over two cross-section sizes, e.g., from 16 mm² (6 AWG) to 6 mm² (10 AWG) or from 6 mm² (10 AWG) to 2.5 mm² (14 AWG) (see illustration above).

Commoning via open terminal side with end plate allows jumpering over two cross-section sizes for 16 mm² (6 AWG) and 10 mm² (8 AWG) and one cross-section size for 6/4/2.5 mm² (10/12/14 AWG). An example: from 16 mm² (6 AWG) to 6 mm² (10 AWG) (see illustration above) or from 10 mm² (8 AWG) to 4 mm² (12 AWG).

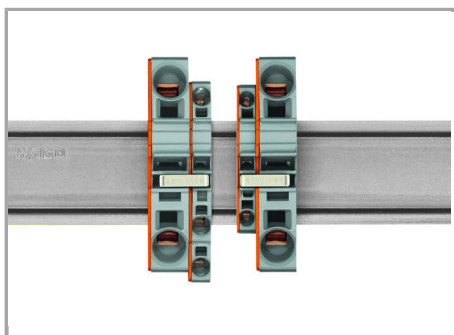

Note:

The total current of the outgoing circuits shall not exceed the nominal current of the step-down jumper/push-in type jumper bar.

Zmiany zastrzeżone

WAGO ELWAG sp. z o. o.
ul. Piękna 58 a
50-506 Wrocław
Tel.: +48 71 3602972 | Fax: +48 71 3602999
Email: wago.elwag@wago.com

Masz pytania dotyczące naszych produktów?
Jesteśmy do Twojej dyspozycji pod numerem telefonu +48 71 360 29 70.