

Switch mode power supplies

78
SERIES



Building automation



Elevators and lifts



Automation for blinds, grilles and shutters



Hoists and cranes



Panels for electrical distribution



Pump Control



12 W Low profile Modular DC Power Supplies for electrical cabinets

Type 78.12....2400

- Output 24 V DC, 12 W
- 17.5 mm (1 module) x 61 mm deep

Type 78.12....1200

- Output 12 V DC, 12 W
- 17.5 mm (1 module) x 61 mm deep

- Low (< 0.4 W) stand-by power consumption
- Thermal protection: internal, with V_{out} shutdown - power OFF to reset
- Short circuit protection: Hiccup (auto-recovery) mode
- Overvoltage protection: Varistor
- Flyback topology
- Compliant with EN 60950-1 and EN 61204-3
- Parallel working for automatic redundancy - with OR diodes
- Dual Polarity and Series connection permissible
- 35 mm rail (EN 60715) mount

Screw terminal



For outline drawing see page 25

Output specification

Output current (-20...+40 °C, 230 V AC input)	A	0.63	1.25
Rated current I_N (50 °C, full input operating range)	A	0.50	1
Rated voltage	V	24	12
Rated power	W	12	12
Output power (-20...+40 °C, 230 V AC input)	W	15	15
Peak current capability for 3 ms*	A	2	3
Output voltage adjust	V	—	—
Voltage variation (from no-load to full-load)		< 1%	< 1%
Voltage ripple @ full load**	mV	< 200	< 200
Hold-up time @ full load: with 100 V AC input ms		> 10	> 10
	with 260 V AC input ms	> 90	> 90

Input specification

Nominal voltage (U_N)	V AC (50/60 Hz)	110...240	110...240
	V DC (not polarized)	220	220
Operating range	V AC (50/60 Hz)	100...265***	100...265***
	V DC	140...370	140...370
Max power consumption (@ 100 V AC, 50 Hz)	VA	28.2	32
	W	14.2	17.2
Stand-by power consumption	W	< 0.4	< 0.4
Power factor		0.50	0.53
Max current consumption (@ 88 V AC)	A	0.25	0.30
Max. inrush current (peak @ 265 V) for 3 ms	A	10	10
Replaceable input fuse		—	—

Technical data

Efficiency (@ 230 V AC)	%	85	87
MTTF	h	> 400 · 10 ³	> 400 · 10 ³
Start-up delay	s	< 1	< 1
Dielectric strength between input/output	V AC	2500	2500
Dielectric strength between input/PE	V AC	—	—
Ambient temperature range****	°C	-20...+60	-20...+60
Protection category		IP 20	IP 20

Approvals (according to type)



78.12....2400



• 24 V DC, 12 W output

78.12....1200



• 12 V DC, 12 W output

* (see diagrams P78)

** peak to peak, 100 Hz component, with 100 V AC input

*** 88...100 V AC with output current limited to 80% I_N

**** (see derating diagrams L78)

**25 W Low profile Modular DC
Power Supplies for electrical cabinets**
Type 78.25....2400

- Output 24 V DC, 25 W
- 35 mm (2-module) x 61 mm deep

Type 78.25....1200

- Output 12 V DC, 25 W
- 35 mm (2-module) x 61 mm deep
- Low (< 0.4 W) stand-by power consumption
- Thermal protection: internal, with V_{out} shutdown - power OFF to reset
- Short circuit protection: Hiccup (auto-recovery) mode
- Overvoltage protection: Varistor
- Flyback topology
- Compliant with EN 60950-1 and EN 61204-3
- Parallel working for automatic redundancy - with OR diodes
- Dual Polarity and Series connection permissible
- 35 mm rail (EN 60715) mount

Screw terminal

78.25....2400

- 24 V DC, 25 W output

78.25....1200

- 12 V DC, 25 W output

- * (see diagrams P78)
- ** peak to peak, 100 Hz component, with 100 V AC input
- *** 88...100 V AC with output current limited to 80% I_N
- **** (see derating diagrams L78)

For outline drawing see page 25

Output specification

Output current (-20...+40 °C, 230 V AC input)	A	1	2.1
Rated current I_N (50 °C, full input operating range)	A	0.75	1
Rated voltage	V	24	12
Rated power	W	25	25
Output power (-20...+40 °C, 230 V AC input)	W	25	25
Peak current capability for 3 ms*	A	3	4
Output voltage adjust	V DC	—	—
Voltage variation (from no-load to full-load)		< 1%	< 1%
Voltage ripple @ full load**	mV	< 200	< 200
Hold-up time @ full load:	with 100 V AC input ms	>40	> 40
	with 260 V AC input ms	>100	> 100

Input specification

Nominal voltage (U_N)	V AC (50/60 Hz)	110...240	110...240
	V DC (not polarized)	220	220
Operating range	V AC (50/60 Hz)	100...265***	110...265***
	V DC	140...370	140...370
Max power consumption (@ 100 V AC, 50 Hz)	VA	56.4	56
	W	27.5	27.3
Stand-by power consumption	W	≤ 0.5	≤ 0.30
Power factor		0.50	0.50
Max current consumption (@ 88 V AC)	A	0.43	0.43
Max. inrush current (peak @ 265 V) for 3 ms	A	20	20
Replaceable input fuse		—	—

Technical data

Efficiency (@ 230 V AC)	%	89	89
MTTF	h	> 400 · 10 ³	> 400 · 10 ³
Start-up delay	s	< 1	< 1
Dielectric strength between input/output	V AC	2500	2500
Dielectric strength between input/PE	V AC	—	—
Ambient temperature range****	°C	-20...+60	-20...+60
Protection category		IP 20	IP 20

Approvals (according to type)

CE EAC

36 W, 60 W and 50 W High efficiency, low profile Modular DC Power Supplies for electrical cabinets

Type 78.36

- Output 24 V DC, 36 W
- Input fuse: Easily replaceable plus spare
- 70 mm (4-module) wide x 61 mm deep

Type 78.60

- Output 24 V DC, 60 W

Type 78.50

- Output 12 V DC, 50 W

- High efficiency (up to 91%)
- Low (< 0.4 W) stand-by power consumption
- Thermal protection: internal, with V_{out} shutdown - power OFF to reset
- Short circuit protection: Hiccup (auto-recovery) mode
- Input fuse: Easily replaceable plus spare
- Overvoltage protection: Varistor
- Flyback topology
- ZVS (Zero-voltage-switching), quasi-resonant mode switching
- Compliant with EN 60950-1 and EN 61204-3
- Parallel working for automatic redundancy - with OR diodes
- Dual Polarity and Series connection permissible
- Compact dimensions: 70 mm (4-modules) wide, 61 mm deep
- 35 mm rail (EN 60715) mount

Screw terminal



For outline drawing see page 25

Output specification

Output current (-20...+40 °C, 230 V AC input)	A	1.7	2.8	4.6
Rated current I _N				
(50 °C, input (100...265)V AC - (140...370)V DC)	A	1.5	2.5	4.2
Rated voltage	V	24	24	12
Rated power	W	36	60	50
Output power (-20...+40 °C, 230 V AC input)	W	40	68	55
Peak current capability for 3 ms*	A	8	10	12
Output voltage adjust	V	—	24...28	12...14
Voltage variation (from no-load to full-load)		< 1%	< 1%	< 1%
Voltage ripple @ full load**	mV	< 200	< 200	< 200
Hold-up time @ full load: with 100 V AC input	ms	> 20	> 20	> 30
with 260 V AC input	ms	> 100	> 130	> 150

Input specification

Nominal voltage (U _N)	V AC (50/60 Hz)	110...240	110...240	110...240
	V DC (not polarized)	220	220	220
Operating range	V AC (50/60 Hz)	100...265***	88...265	88...265
	V DC	140...370	140...370	140...370
Max power consumption	VA	57.5	90	89
(@ 100 V AC, 50 Hz)	W	43	67.5	58.3
Stand-by power consumption	W	< 0.4	< 0.4	< 0.4
Power factor		0.74	0.75	0.65
Max current consumption (@ 88 V AC)	A	0.6	0.9	0.85
Max. inrush current (peak @ 265 V) for 3 ms	A	12	30	30
Replaceable input fuse		1 A - T	1.6 A - T	1.6 A - T

Technical data

Efficiency (@ 230 V AC)	%	86	91	90
MTTF	h	> 600 · 10 ³	> 500 · 10 ³	> 400 · 10 ³
Start-up delay	s	< 1	< 1	< 1
Dielectric strength between input/output	V AC	3000	3000	3000
Dielectric strength between input/PE	V AC	—	1500	1500
Ambient temperature range****	°C	-20...+70	-20...+70	-20...+70
Protection category		IP 20	IP 20	IP 20

Approvals (according to type)



• 24 V DC, 36 W output



• 24 V DC, 60 W output
• Output adjustable between 24-28 V
• ZVS technology



• 12 V DC, 50 W output
• Output adjustable between 12-14 V
• ZVS technology

Replaceable fuse + spare



* (see diagrams P78)

** peak to peak, 100 Hz component, with 100 V AC input

*** 88...100 V AC with output current limited to 80% I_N

**** (see derating diagrams L78)

60 W and 50 W High efficiency, low profile Modular DC Power Supplies for electrical cabinets
Fold-Back overload characteristics for Battery charging applications and parallel working for increased load current
Type 78.61

- Output 24 V DC, 60 W

Type 78.51

- Output 12 V DC, 50 W
- High efficiency (up to 91%)
- Low (< 0.4 W) stand-by power consumption
- Thermal protection: internal, with V_{out} shutdown - power OFF to reset
- Short circuit protection: Hiccup (auto-recovery) mode
- Overload protection: Fold-back mode
- Input fuse: Easily replaceable plus spare
- Overvoltage protection: Varistor
- Flyback topology
- ZVS (Zero-voltage-switching), quasi-resonant mode switching
- Compliant with EN 60950-1 and EN 61204-3
- Parallel working for increased load current (with OR diodes)
- Dual Polarity and Series connection permissible
- Compact dimensions: 70 mm (4-modules) wide, 60 mm deep
- 35 mm rail (EN 60715) mount

Screw terminal

For outline drawing see page 25

Output specification

Output current (-20...+40 °C, 230 V AC input)	A	2.6	4.6
Rated current I_N			
(50 °C, input (100...265)V AC - (140...370)V DC)	A	2.5	4.2
Rated voltage	V	24	12
Rated power	W	60	50
Output power (-20...+40 °C, 230 V AC input)	W	68	55
Peak current capability for 3 ms*	A	8	12
Output voltage adjust	V	24...28	12...15
Voltage variation (from no-load to full-load)		< 1%	< 1%
Voltage ripple @ full load**	mV	< 200	< 200
Hold-up time @ full load: with 100 V AC input ms		> 20	> 30
with 260 V AC input ms		> 130	> 150

Input specification

Nominal voltage (U_N)	V AC (50/60 Hz)	110...240	110...240
	V DC (not polarized)	220	220
Operating range	V AC (50/60 Hz)	88...265	88...265
	V DC	140...370	140...370
Max power consumption (@ 100 V AC, 50 Hz)	VA	90	89
	W	67.5	58.3
Stand-by power consumption	VA	< 0.4	< 0.4
	W	< 0.4	< 0.4
Power factor		0.75	0.65
Max current consumption (@ 88 V AC)	A	0.9	0.85
Max. inrush current (peak @ 265 V) for 3 ms	A	30	30
Replaceable input fuse		1.6 A - T	1.6 A - T

Technical data

Efficiency (@ 230 V AC)	%	91	90
MTTF	h	> 500 · 10 ³	> 400 · 10 ³
Start-up delay	s	< 1	< 1
Dielectric strength between input/output	V AC	3000	3000
Dielectric strength between input/PE	V AC	1500	1500
Ambient temperature range***	°C	-20...+70	-20...+70
Protection category		IP 20	IP 20

Approvals (according to type)

78.61

- 24 V DC, 60 W output
- Output adjustable between 24-28 V
- ZVS technology
- Suitable for battery charging

78.51

- 12 V DC, 50 W output
- Output adjustable between 12-15 V
- ZVS technology
- Suitable for battery charging

Replaceable fuse + spare



* (see diagrams P78)

** peak to peak, 100 Hz component, with 100 V AC input

*** (see derating diagrams L78)

 suitable for battery charging (see details page 18)

**Industrial Switch Mode DC Power Supplies:
110 W to 130 W**

Type 78.1A

- Output 24 V DC, 120 W

Type 78.1B

- Output 24 V DC, 110 W, compact size
- Secure electrical separation (SELV according to EN 60950)

Type 78.1D

- Output 24 V DC, 130 W
- Double stage active Power Factor Correction

- Fold-Back overload characteristics for Battery charging applications and parallel working for increased load current (78.1D)
- High efficiency (up to 93%)
- Low stand-by power consumption (down to 1 W)
- LLC (78.1B) or forward topology (78.1D)
- Thermal protection: internal with pre-alert alarm via LED and auxiliary contact, and with Vout safety shutdown - power OFF to reset (78.1D)
- Overload indication: Pre-alert alarm via LED and auxiliary contact indication (78.1D)
- Boost current: Without time limit, with LED and auxiliary contact indication (78.1D)
- Overload protection: Fold-back mode (78.1D)
- Short circuit protection: Hiccup (auto-recovery) mode
- Input fuse: Easily replaceable plus spare
- Overvoltage protection: Varistor
- Compliant with EN 60950-1 and EN 61204-3
- Parallel working for increased load current (with OR diodes)
- Dual Polarity and Series connection permissible
- 35 mm rail (EN 60715) mount

For outline drawing see page 25, 26, 27

Output specification

Output current (-20...+50 °C, 230 V AC input)	A	5.0 (@40 °C)
Output current (-20...+50 °C, 120 V AC input)	A	4.5 (@40 °C)
Rated voltage	V	24
Rated power	W	120
Output power (-20...+40 °C, 230 V AC input)	W	120
Peak current capability for 5 ms*	A	10
Output voltage adjust	V DC	24...28
Voltage variation (from no-load to full-load)		< 2%
Voltage ripple @ full load**	mV	< 500
Hold-up time @ full load: with 120 V AC input	ms	>25
with 250 V AC input	ms	>110

Input specification

Nominal voltage (U _N)	V AC (50/60 Hz)	120...240
	V DC	—
Operating range	V AC (50/60 Hz)	120...250
	V DC	—
Drop out DC Voltage	V	—
Max power consumption	VA	195 (@50 Hz)
(@ minimum V AC operating range)	W	134 (@50 Hz)
Stand-by power consumption	W	< 1.9
Power factor		0.69
Max current consumption	A	1.75 (@120 V AC)
Max. inrush current (peak @ 250 V) for 3 ms	A	13
Replaceable input fuse		—

Technical data

Efficiency (@ 230 V AC)	%	92
MTTF	h	> 500 · 10 ³
Start-up delay	s	< 3
Dielectric strength between input/output	V AC	2000
Dielectric strength between input/PE	V AC	—
Ambient temperature range***	°C	-20...+60
Protection category		IP 20

Approvals (according to type)

NEW 78.1A



- 24 V DC, 120 W output
- Output adjustable between 24-28 V

78.1B



- 24 V DC, 110 W output
- Output adjustable between 24-28 V
- Compact size, low stand-by consumption

78.1D



- 24 V DC, 130 W output
- Output adjustable between 24-28 V
- Double stage with active PFC (Power Factor Correction)

Replaceable fuse + spare



Thermal protection with LED indication



(depending on type)

Auxiliary contact signalling



- * (see diagrams P78)
- ** peak to peak, 100 Hz component, with 120 V AC input (see derating diagrams L78)
- *** suitable for battery charging (see details page 18)

**Industrial Switch Mode DC Power Supply:
240 W**
**High efficiency PSU with high peak output
current and low stand by power consumption**
Type 78.2A

- Output 24 V DC, 240 W

- High efficiency (up to 94%)
- Low stand-by power consumption
- LLC topology
- Thermal protection internal, power OFF to reset
- Boost current: Without time limit
- Short circuit protection: Hiccup (auto-recovery) mode
- Overvoltage protection: Varistor
- Compliant with EN 61204-3
- Parallel working for increased load current (with OR diodes)
- Dual Polarity and Series connection permissible
- 35 mm rail (EN 60715) mount

Screw terminal



For outline drawing see page 27

Output specification

Output current (-20...+40 °C, 230 V AC input)	A	10
Output current (-20...+40 °C, 120 V AC input)	A	9
Rated voltage	V	24
Rated power	W	240
Output power (-20...+40 °C, 230 V AC input)	W	240
Peak current capability for 5 ms*	A	25
Output voltage adjust	V DC	24...28
Voltage variation (from no-load to full-load)		< 3%
Voltage ripple @ full load**	mV	< 300
Hold-up time @ full load: with 100 V AC input	ms	> 30
with 250 V AC input	ms	> 50

Input specification

Nominal voltage (U _N)	V AC (50/60 Hz)	120 or 230
Operating range	V AC (50/60 Hz)	95...130 or 185...250
Drop out DC Voltage	V	—
Max power consumption	VA	361 (@ 50 Hz)
(@ minimum V AC operating range)	W	265 (@ 50 Hz)
Stand-by power consumption	W	≤ 3 @ 120 V ; ≤ 2.6 W @ 230 V
Power factor		0.73
Max current consumption	A	3.5 (@ 100 V AC)
Max. inrush current (peak @ 265 V) for 3 ms	A	14
Replaceable input fuse		—

Technical data

Efficiency (@ 230 V AC)	%	94
MTTF	h	> 400 · 10 ³
Start-up delay	s	< 1
Dielectric strength between input/output	V AC	2000
Dielectric strength between input/PE	V AC	—
Ambient temperature range***	°C	-20...+60
Protection category		IP 20

Approvals (according to type)

NEW 78.2A

- 24 V DC, 240 W output
- Output adjustable between 24-28 V

- * (see diagrams P78)
- ** peak to peak, 100 Hz component, with 100 V AC input
- *** (see derating diagrams L78)
-  suitable for battery charging

**Industrial Switch Mode DC Power Supply:
240 W**

Overload characteristics support parallel working for increased load current

Type 78.2E

- Output 24 V DC, 240 W
- Double stage active Power Factor Correction
- High efficiency (up to 93%)
- Low stand-by power consumption
- Forward topology
- Thermal protection: internal with pre-alert alarm via LED and auxiliary contact, and with V_{out} safety shutdown - power OFF to reset
- Overload indication: Pre-alert alarm via LED and auxiliary contact indication
- Boost current: Without time limit, with LED and auxiliary contact indication
- Overload up to 20 A
- Short circuit protection: Hiccup (auto-recovery) mode
- Input fuse: Easily replaceable plus spare
- Overvoltage protection: Varistor
- Compliant with EN 60950-1 and 61204-3
- Parallel working for increased load current (with OR diodes)
- Dual Polarity and Series connection permissible
- 35 mm rail (EN 60715) mount

Screw terminal



For outline drawing see page 26

Output specification

Output current (-20...+40 °C, 230 V AC input)	A	10.8
Rated current I_N (50 °C, full input operating range)	A	10
Rated voltage	V	24
Rated power	W	240
Output power (-20...+40 °C, 230 V AC input)	W	250
Peak current capability for 5 ms*	A	25
Output voltage adjust	V DC	24...28
Voltage variation (from no-load to full-load)		< 1%
Voltage ripple @ full load**	mV	< 100
Hold-up time @ full load: with 110 V AC input	ms	> 20
with 260 V AC input	ms	> 20

Input specification

Nominal voltage (U_N)	V AC (50/60 Hz)	110...240
	V DC	110...240
Operating range	V AC (50/60 Hz)	88...265
	V DC	90...275 (non-polarised)
Drop out DC Voltage	V	80
Max power consumption (@ minimum V AC operating range)	VA	275 (@ 50 Hz)
	W	274 (@ 50 Hz)
Stand-by power consumption (@ 88 V)	W	≤ 2.8
Power factor		0.995
Max current consumption	A	3.0 (@ 88 V AC)
Max. inrush current (peak @ 265 V) for 3 ms	A	12
Replaceable input fuse		3.15 A - T

Technical data

Efficiency (@ 230 V AC)	%	93
MTTF	h	> 400 · 10 ³
Start-up delay	s	< 1
Dielectric strength between input/output	V AC	2500
Dielectric strength between input/PE	V AC	1500
Ambient temperature range***	°C	-20...+70
Protection category		IP 20

Approvals (according to type)

78.2E



- 24 V DC, 240 W output
- Output adjustable between 24-28 V
- Double stage with active PFC (Power Factor Correction)

Replaceable fuse + spare



Thermal protection with LED indication



Auxiliary contact signalling



* (see diagrams P78)

** peak to peak, 100 Hz component, with 110 V AC input

*** (see derating diagrams L78)

KNX power supply with 30 V DC output - 640 mA

- Output 30 V DC 640 mA, KNX Bus
- Diagnostic LEDs
- 72 mm wide (4 modules)
- 35 mm rail (EN 60715) mount
- Suitable for ETS 4 (or latest versions)

78.2K

Screw terminal

NEW 78.2K.1.230.3000

- Thermal protection, overload protection and short-circuit protection
 - No minimum distance required between adjacent power supplies.
- It is possible to use two or more power supplies within a panel to provide for redundancy

F

For outline drawing see page 28

Output specification

Output current	mA	640
Output voltage	V	30

Input specification

Nominal voltage (U _N)	V AC	230...240
Operating range	V AC	185 - 260
Stand-by power consumption	W	1.45
Power factor		0.62
Max current consumption	A	0.25

Technical data

Dielectric strength between input/output	V AC	3000
Ambient temperature range	°C	-5/+45
Protection category		IP 20

Approvals (according to type)

Ordering information

Example: 78 series switch mode power supply, 36 W - 24 V DC output, supply voltage 110...240 V AC, replaceable fuse.

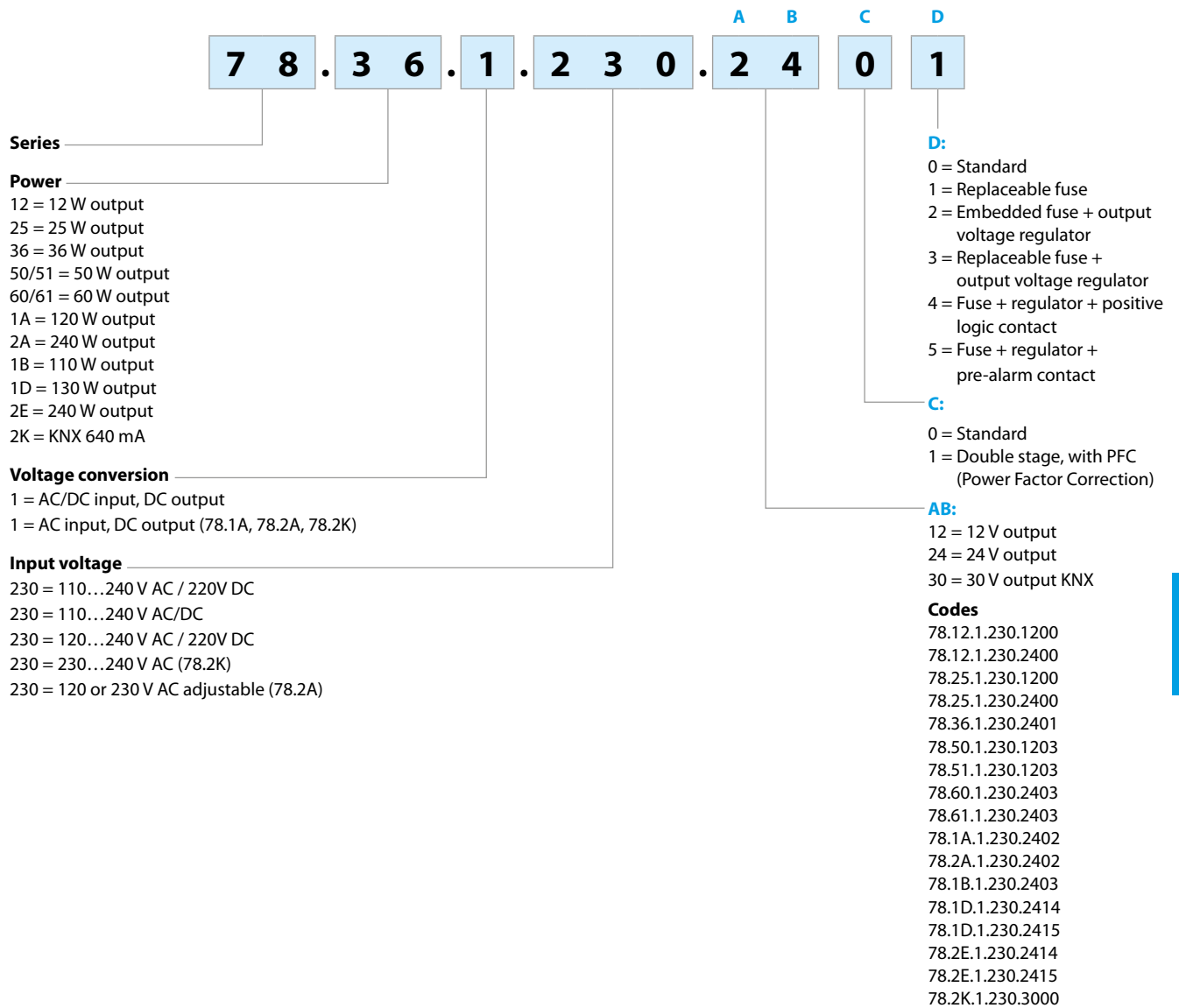

Technical data

EMC specifications (according to EN 61204-3)		Reference standard	78.12, 78.25, 78.36	78.60, 78.50	78.61, 78.51	78.1A	78.1B	78.1D	78.2A	78.2E
Electrostatic discharge	contact discharge	EN 61000-4-2	4 kV	4 kV	4 kV	4 kV	4 kV	4 kV	4 kV	4 kV
	air discharge	EN 61000-4-2	8 kV	8 kV	8 kV	8 kV	8 kV	8 kV	8 kV	8 kV
Radiated electromagnetic field	80...1000 MHz	EN 61000-4-3	6 V/m	10 V/m	10 V/m	10 V/m	10 V/m	10 V/m	10 V/m	10 V/m
	1...2.8 GHz	EN 61000-4-3	3 V/m	3 V/m	3 V/m	3 V/m	3 V/m	3 V/m	10 V/m	10 V/m
Fast transients (burst 5/50 ns, 5 and 100 kHz)	on supply terminals	EN 61000-4-4	2 kV	3 kV	3 kV	2 kV	2 kV	3 kV	3 kV	3 kV
Voltage pulses on supply terminals (surge 1.2/50 µs)	common mode	EN 61000-4-5	2 kV	2 kV	2 kV	2 kV	2 kV	3 kV	2.5 kV	2.5 kV
	differential mode	EN 61000-4-5	2 kV (78.12), 4 kV* (78.36)	4 kV*	4 kV*	4 kV**	4 kV**	4 kV**	4 kV	4 kV**
Radio-frequency common mode voltage (0.15...230 MHz)	on supply terminals	EN 61000-4-6	6 V	10 V	10 V	10 V	10 V	10 V	10 V	10 V
Short interruptions		EN 61000-4-11	5 cycles	6 cycles	6 cycles	5 cycles	5 cycles	6 cycles	5 cycles	5 cycles
Radio-frequency conducted emissions	0.15...30 MHz	EN 55022	class B	class A	class B	class A	class B	class B	class A	class B
Radiated emissions	30...1000 MHz	EN 55022	class B	class A	class B	class A	class A	class A	class A	class A
Terminals			Max			Min...Max				
Wire size (Solid cable, stranded cable)		mm ²	1 x 4 / 2 x 2.5			1 x 0.5...1 x 4				
		AWG	1 x 12 / 2 x 14			1 x 20...1 x 12				
Wire size (Solid cable, stranded cable for 78.1A and 78.2A)		mm ²	1 x 2.5			1 x 0.5...2.5				
		AWG	1 x 14			1 x 20...14				
 Screw torque		Nm	0.8			0.5				
Wire strip length		mm	8 / 8 (for 78.1A and 78.2A)			8 / 8 (for 78.1A and 78.2A)				
Other data										
Power lost to the environment with rated output current		W	2 (78.12), 2.3 (78.25), 5 (78.36, 78.50/51), 5.4 (78.60/61)							
		W	10 (78.1A), 9 (78.1B), 13.2 (78.1D), 15.3 (78.2A), 16.8 (78.2E)							

* input fuse may blow for surges higher than 1.5 kV

** input fuse may blow for surges higher than 2 kV

Technical data for 78.2K

EMC specifications (according to EN 61204-3)		Reference standard	78.2K
Electrostatic discharge	contact discharge	EN 61000-4-2	4 kV
	air discharge	EN 61000-4-2	8 kV
Radiated electromagnetic field	80...1000 MHz	EN 61000-4-3	10 V/m
	1...2.8 GHz	EN 61000-4-3	3 V/m
Fast transients (burst 5/50 ns, 5 and 100 kHz)	HBES terminals	EN 61000-4-4	1 kV
	on supply terminals	EN 61000-4-4	2 kV
Voltage pulses on supply terminals (surge 1.2/50 µs)	DM supply terminals	EN 61000-4-5	1 kV
	CM supply terminals	EN 61000-4-5	2 kV
	HBES terminals	EN 61000-4-5	2 kV
Radio-frequency common mode voltage (0.15...230 MHz)	HBES terminals	EN 61000-4-6	10 V
	on supply terminals	EN 61000-4-6	10 V
Short interruptions	criterion A	EN 61000-4-11	10 cycles
Radio-frequency conducted emissions	0.15...30 MHz	EN 55022	class B
Radiated emissions	30...1000 MHz	EN 55022	class B
Terminals			Max
Wire size (Solid cable, stranded cable)		mm ²	1 x 4 / 2 x 2.5
		AWG	1 x 12 / 2 x 14
 Screw torque		Nm	0.8
Wire strip length		mm	9
Other data			
Power lost to the environment with rated output current		W	4.8

DM: differential mode

CM: common mode

Output specification

L78-1 Output current v ambient temperature (78.12)

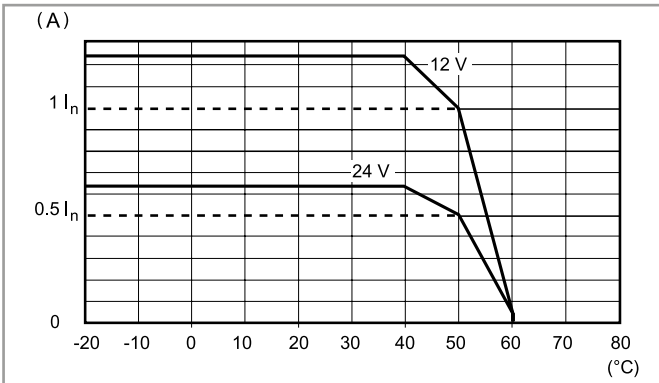

P78-1 Output peak current v time (78.12)

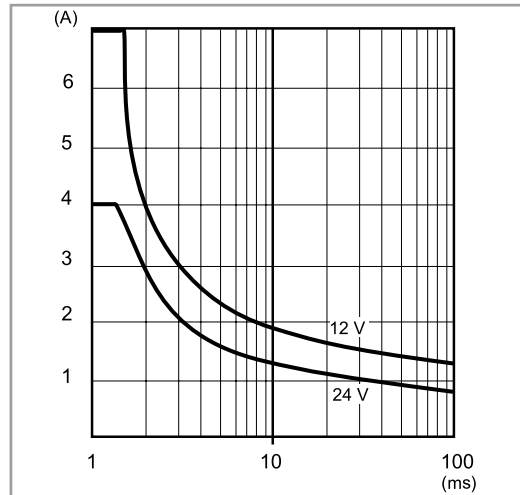

L78-2 Output current v ambient temperature (78.25)

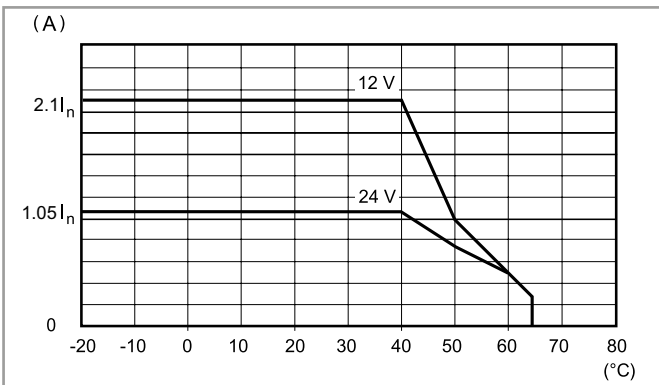

P78-2 Output peak current v time (78.25)

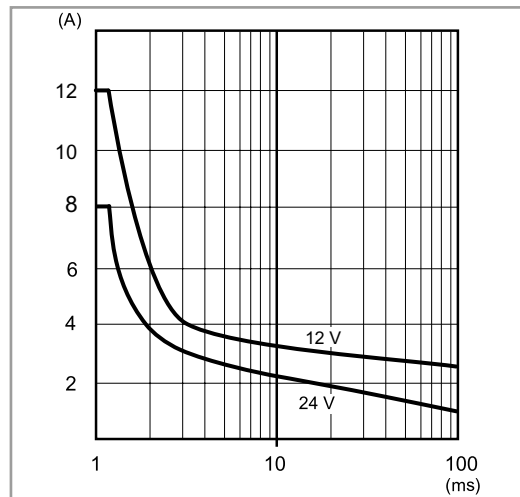

L78-3 Output current v ambient temperature (78.36)

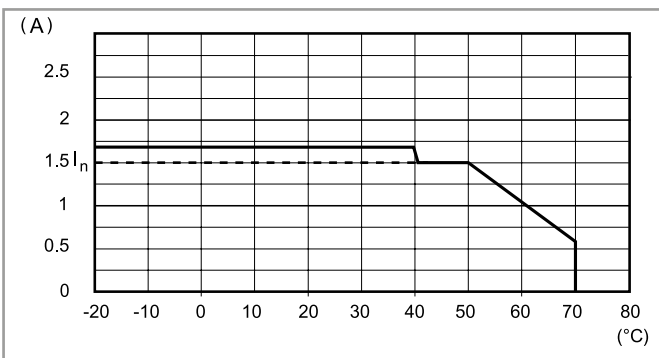

P78-3 Output peak current v time (78.36)

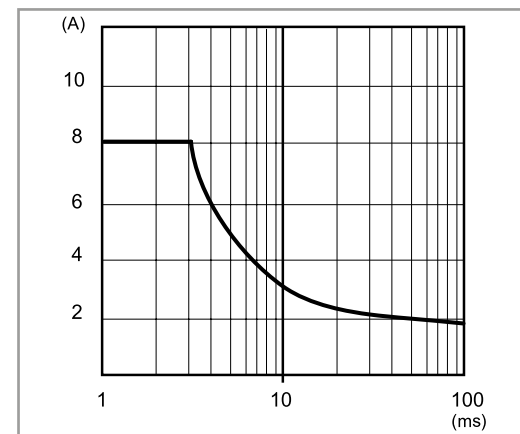

F

Output specification

L78-4 Output current v ambient temperature (78.60)

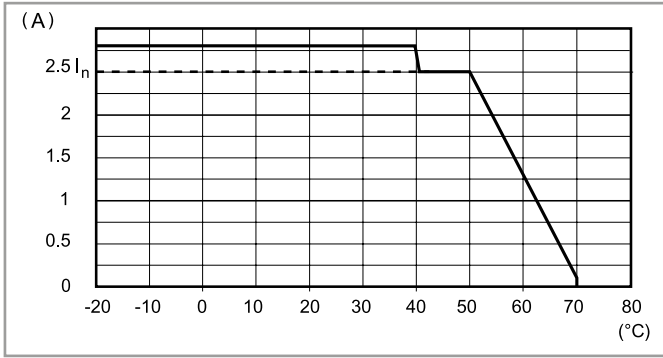

P78-4 Output peak current v time (78.60)

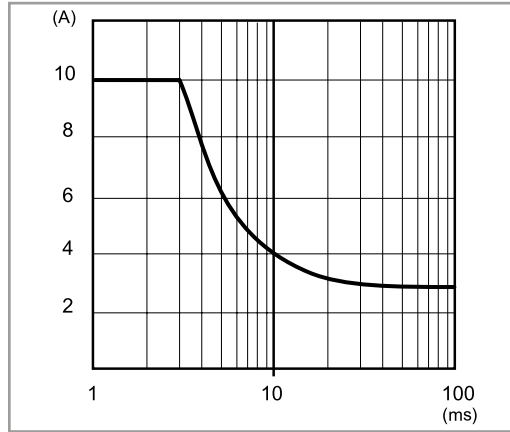

L78-5 Output current v ambient temperature (78.50/51)

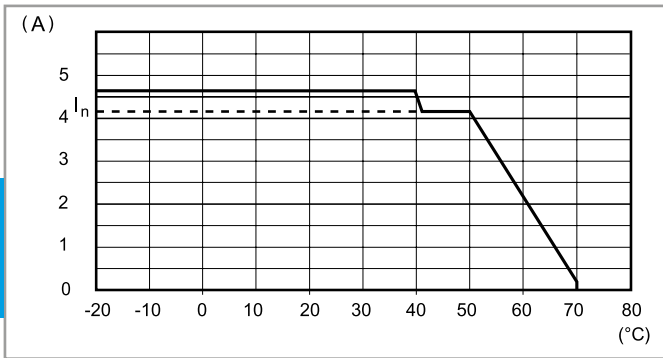

P78-5 Output peak current v time (78.50/51)

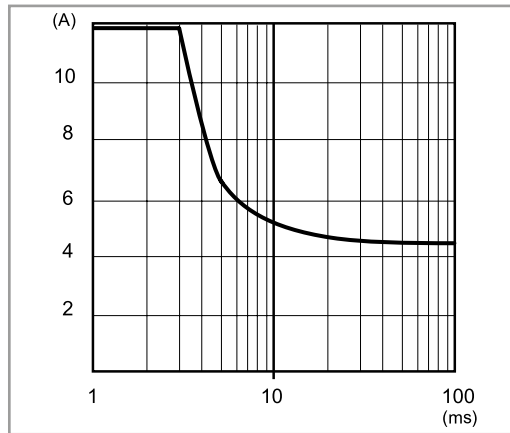

L78-6 Output current v ambient temperature (78.61)

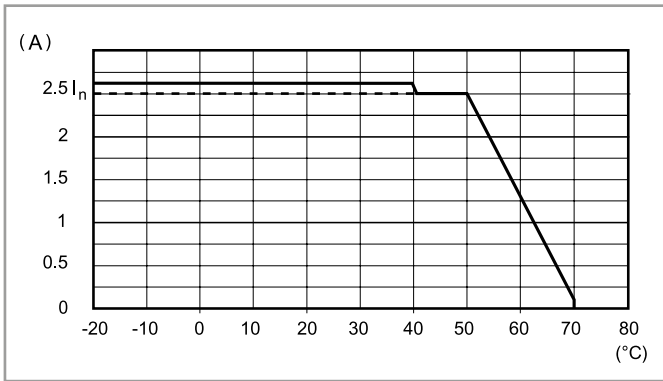

P78-6 Output peak current v time (78.61)

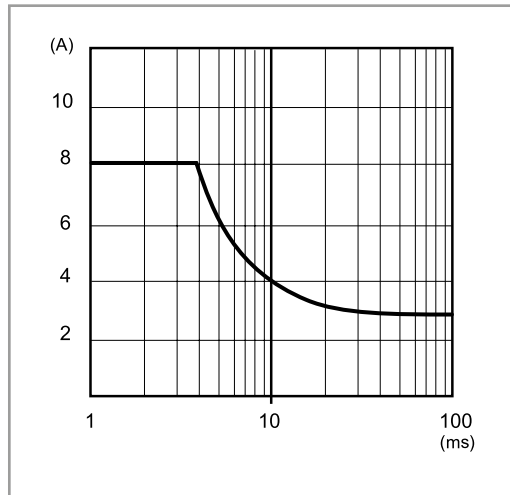

F

Output specification

L78-7 Output current v ambient temperature (78.1A)

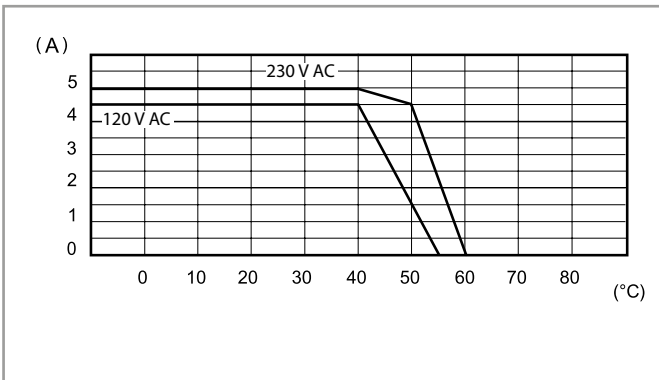

P78-7 Output peak current v time (78.1A)

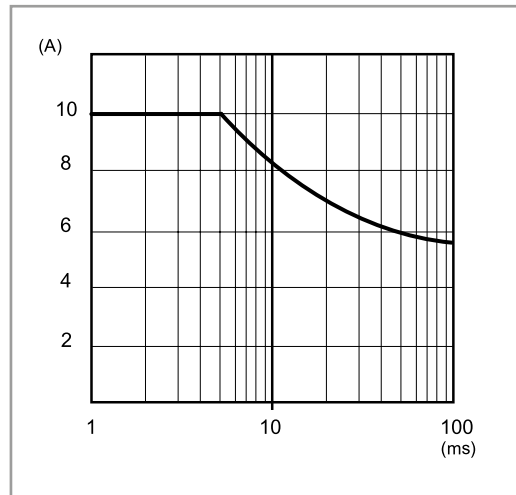

L78-8 Output current v ambient temperature (78.1B)

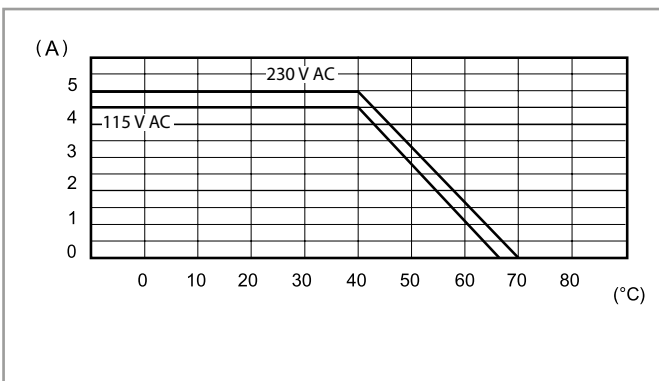

P78-8 Output peak current v time (78.1B)

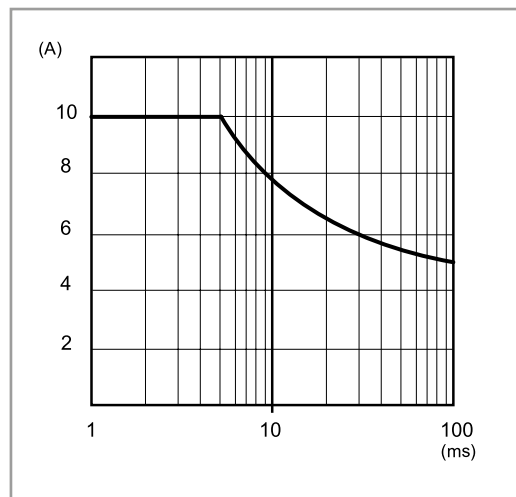

L78-9 Output current v ambient temperature (78.1D)

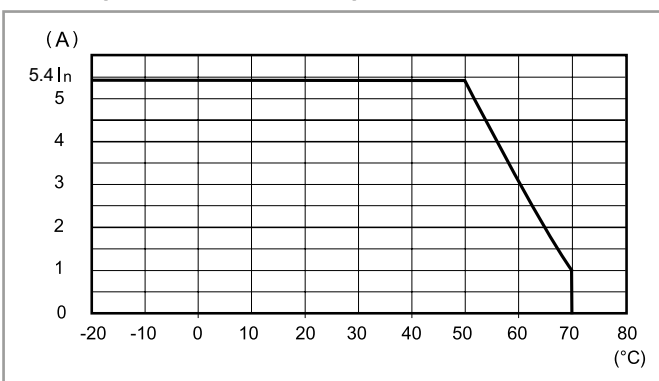

P78-9 Output peak current v time (78.1D)

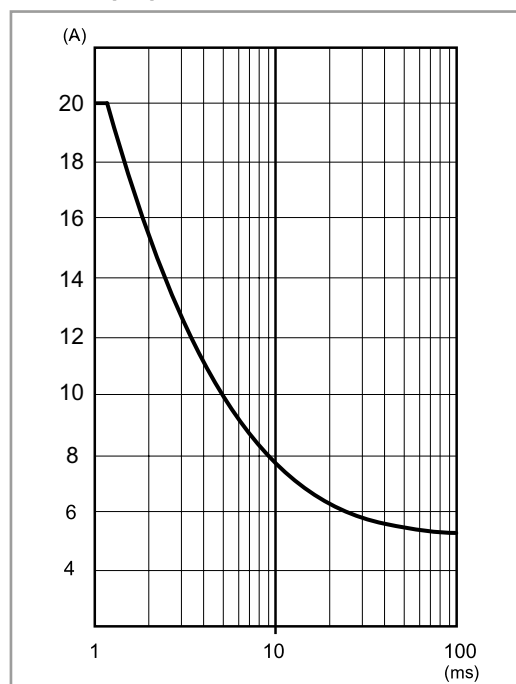

Output specification

L78-10 Output current v ambient temperature (78.2A)

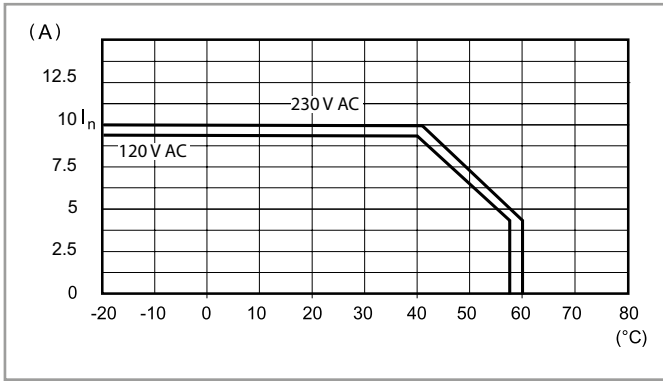

P78-10 Output peak current v time (78.2A)

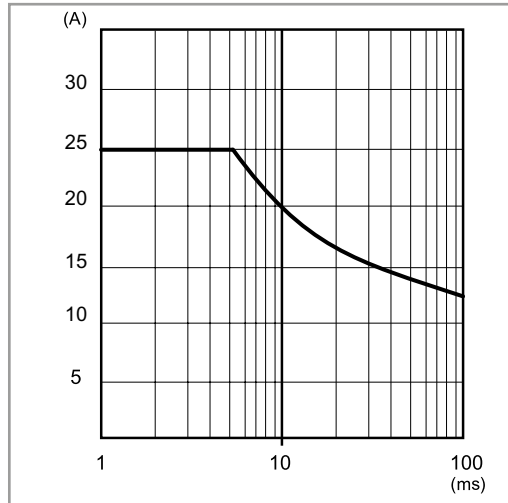

F L78-11 Output current v ambient temperature (78.2E)

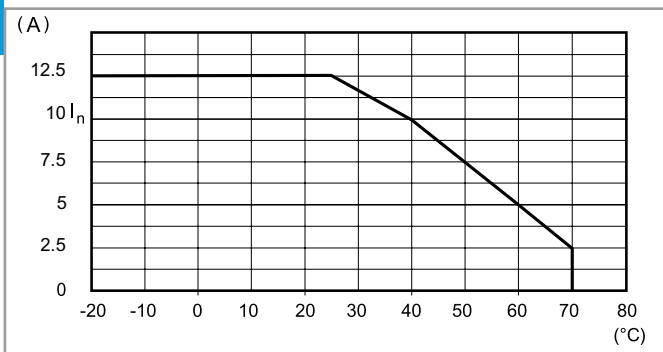

P78-11 Output peak current v time (78.2E)

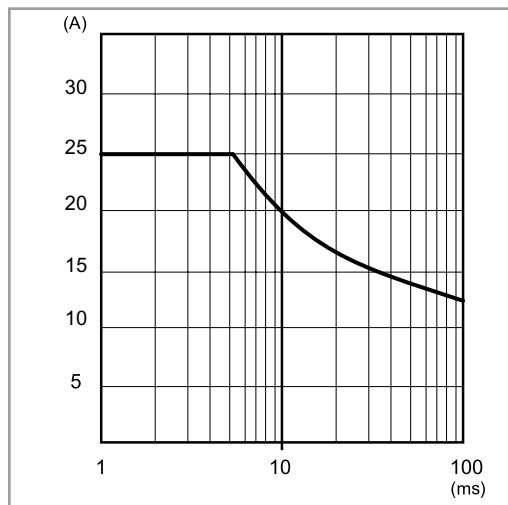

Output specification

FB78-5 Output voltage v output current (78.2E)

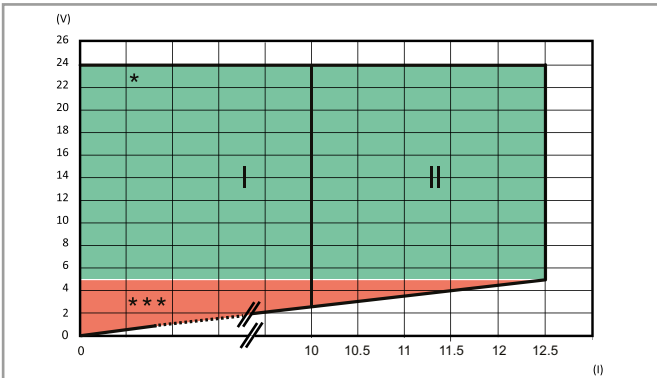

I: Output characteristic for temperature up to 50 °C

II: Output characteristic for temperature up to 25 °C

* / ***: See LED table below

FB78-6 Output voltage v output current (78.2K)

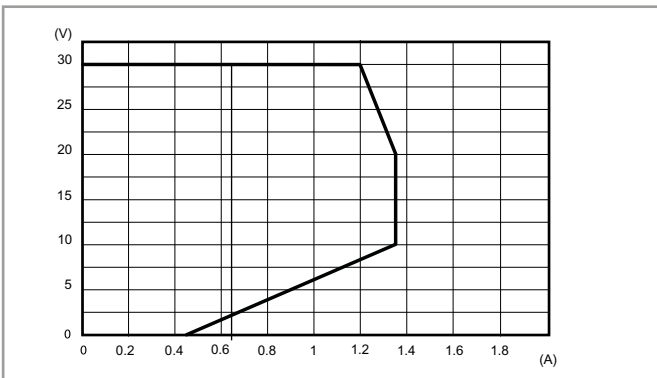

Overload diagram, KNX approved

Hiccup mode

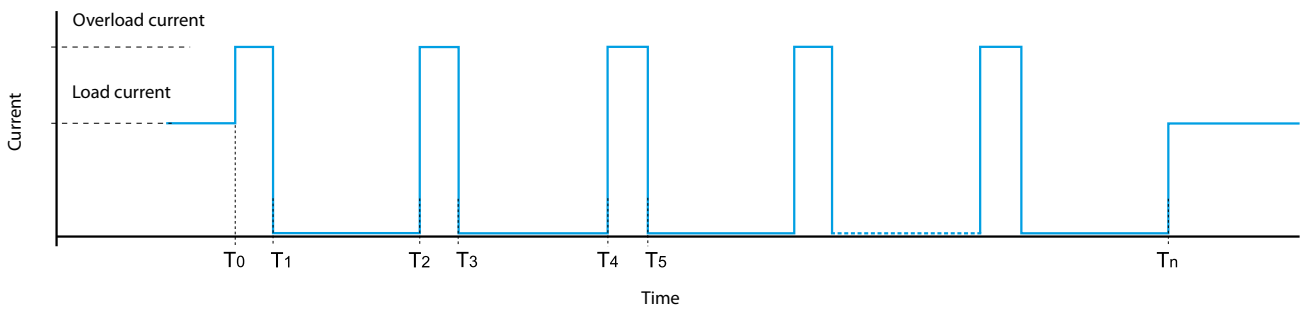

Under normal conditions, the 78 Series Power Supply supplies the current required by the load.

However, under abnormal conditions such as a short circuit or heavy overload (T_0) the output voltage will be rapidly reduced to zero - followed by the current (T_1). After approximately 2 seconds (T_1 to T_2), the power supply checks for the persistence of the anomaly over the time period T_2 to T_3 (30 to 100ms - dependent on the type of anomaly). If the anomaly persists, as shown above, the current is again reset to 0 A for a further 2 s (T_3 to T_4). This "hiccup" process is repeated until the anomaly is removed (T_n), whereon the power supply then returns to normal working.

78.1B is able to handle this anomaly for 15 s. After this time it enters in protection mode, and a manual reset is necessary by removing and re-applying the supply voltage

Fold-back technology and battery charging

Fold-back technology allows load current to be maintained under conditions of heavy overload. In case of heavy overload, the fold-back circuit will provide the output current and the output voltage, in accordance with the relevant "FB" diagram. In practice, when overcurrent is drawn by the load, the fold-back circuit reduces the output voltage supplying the current up to the maximal value, then it starts to work in hiccup mode. Also in case of short circuit, the power supply will work in hiccup mode. Both these conditions end when the anomaly is removed, and the power supply returns to normal working.

The fold-back mode allows the use of the power supply as a **battery charger**, in particular 78.51/61 for charging lead acid batteries (both standard and gel types) rated 7...24 Ah and 78.1D for charging lead batteries rated 17...38 Ah. In any case, it is necessary to verify that the charging characteristics of the batteries are compliant with the output characteristics of the power supply.

It is suggested to insert a diode in series between the + output and the + input of the battery (if not already installed in the battery unit).

Back-up connection for mains interruption

When the mains is ON, the power supply is able to charge the battery and supply the load at the same time (the power supply must be rated minimum 110 % of the load). When the mains is OFF, the battery starts to supply the load.

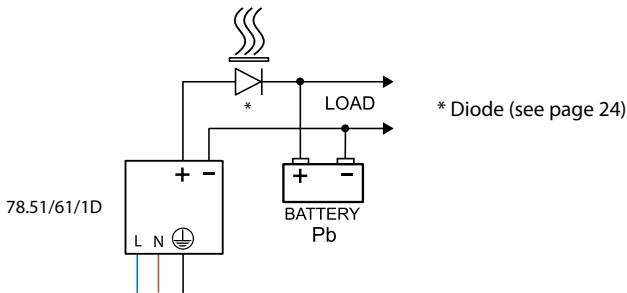

FB78-1 Output voltage v output current (78.51)

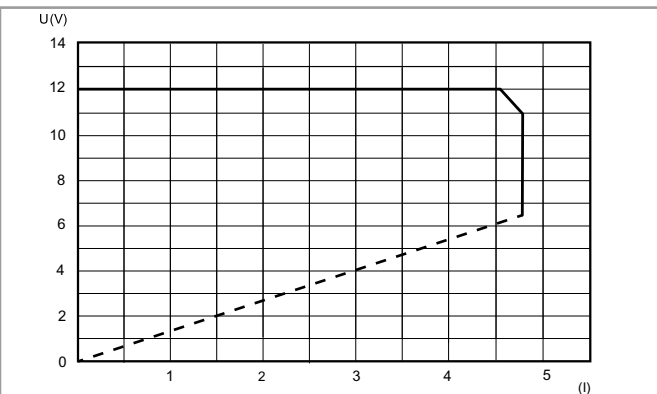

FB78-2 Output voltage v output current (78.61)

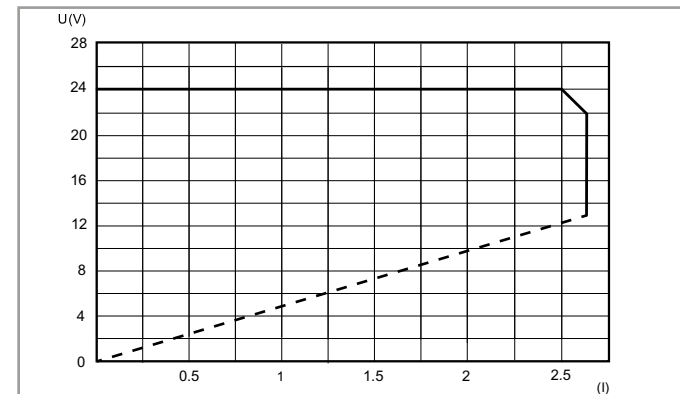

FB78-3 Output voltage v output current (78.1D)

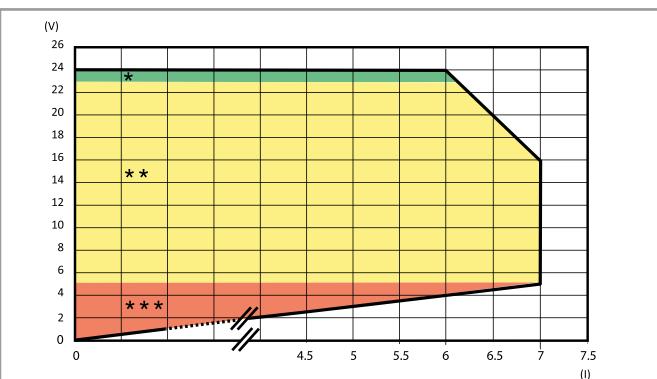

Fold-back characteristic for ambient temperature up to 50 °C

* / ** / ***: See LED table below

78.1D, 78.2E LED table

Feedback contact switching mode: Type 78.xx.x.xxx.24x4 ("positive logic")

The NO contact closes when power is applied to the unit and remains closed unless there is a serious fault preventing the power supply unit from delivering output current. (Such as a broken fuse, power supply failure, short-circuit or thermal protection.)

This version is suitable, for example, for signalling to a remote PLC all those alarms representing a service interruption of the power supply output.

Type	Area	State	LED	Contact 13-14
78.1D.1.230.2414 78.2E.1.230.2414	*	OK	DC OK ALARM OFF	
	**	Overload (78.1D only)	DC OK ALARM OFF	
	***	Short circuit	DC OK ALARM OFF	
		Thermal limit	DC OK ALARM OFF	
		Thermal protection#	DC OK ALARM OFF	

#Remove the supply voltage, following the intervention of the thermal protection, in order to reset the power supply.

78.1D, 78.2E LED table

Feedback contact switching mode: Type 78.xx.x.xxx.24x5 ("pre-alarm")

The NO contact closes when an anomaly happens (Overload, short circuit, thermal limit, thermal protection).

This version is suitable, for example, for activating visual or audible alarms, or to activate a cooling fan.











Type	Area	State	LED	Contact 13-14
78.1D.1.230.2415 78.2E.1.230.2415	*	OK	DC OK ALARM OFF	
	**	Overload (78.1D only)	DC OK ALARM OFF	
	***	Short circuit	DC OK ALARM OFF	
		Thermal limit	DC OK ALARM OFF	
		Thermal protection#	DC OK ALARM OFF	

#Remove the supply voltage, following the intervention of the thermal protection, in order to reset the power supply.

78.12, 78.25, 78.36, 78.50, 78.60, 78.51, 78.61, 78.1A, 78.2A, 78.1B LED table

Type	State	LED
78.12.1.230.xx00 78.25.1.230.1200 78.25.1.230.2400	OK	
78.36.1.230.2401 78.50.1.230.1203 78.60.1.230.2403	Short circuit	
78.51.1.230.1203 78.61.1.230.2403 78.1A.1.230.2402	Thermal limit	OFF
78.2A.1.230.2402 78.1B.1.230.2403	OK	
	Short circuit	 OFF
	Thermal limit	OFF

LED table

Type	Area	State	LED	OUTPUT
78.2K.1.230.3000	CHECK START UP	V_{out} OK	 • OFF • OFF	ON
		V_{out} LOW < 29V	 • OFF • OFF	OFF
		V_{out} HIGH > 33V	• OFF  • OFF	OFF
	NORMAL FUNCTION	V_{out} OK I_{out} > 0.9A	 • OFF 	ON
		V_{out} < 29V I_{out} > 0.9A	• OFF • OFF 	ON
	 Alarm condition: $T_{amb} > 45^{\circ}\text{C}$ @ I_{nom} .	Pre-alarm: up to 60s	 • OFF 	ON
		Latched alarm	• OFF • OFF 	OFF

F

Wiring diagrams for 78.12, 78.25, 78.36, 78.50, 78.51, 78.60 & 78.61

Basic connections

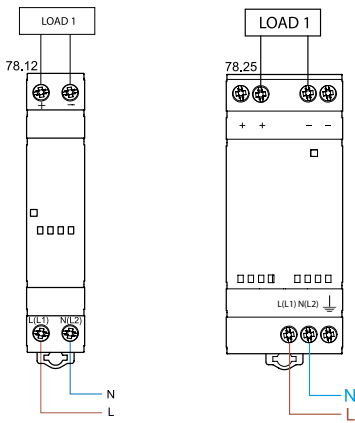

Basic connections

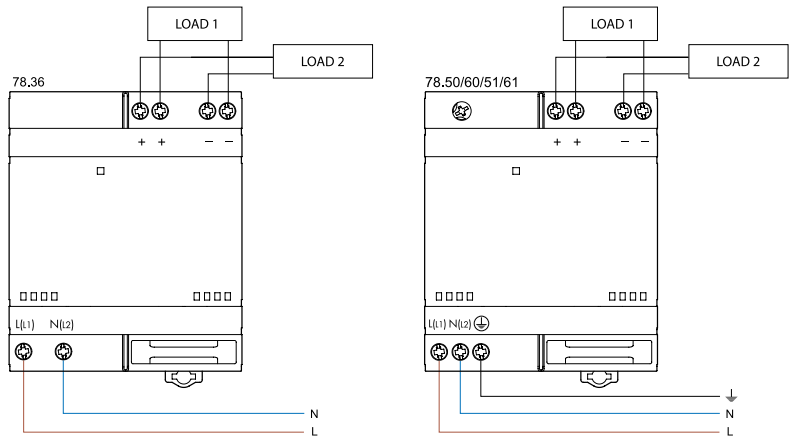

Dual polarity connection

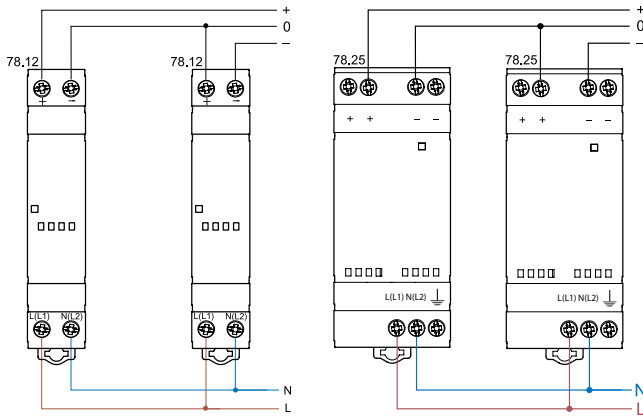

Dual polarity connection

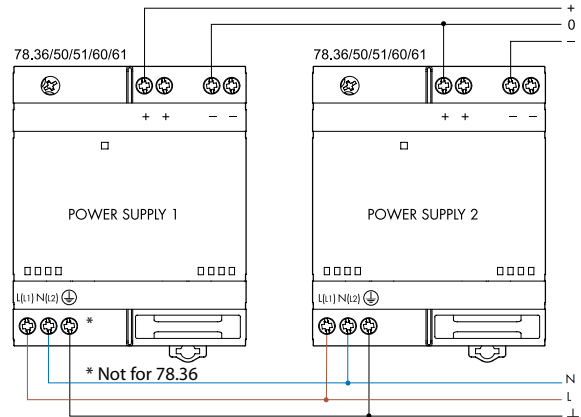

Series connection

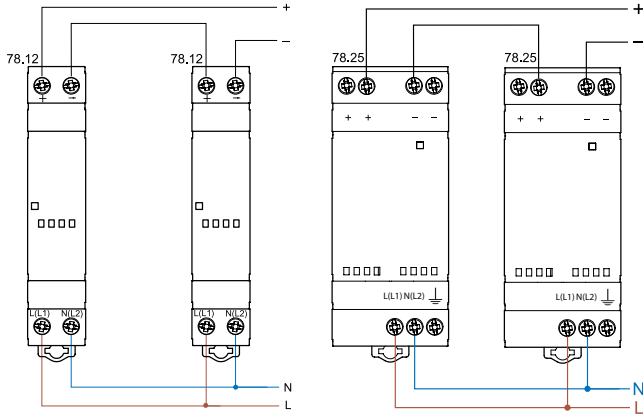

Series connection

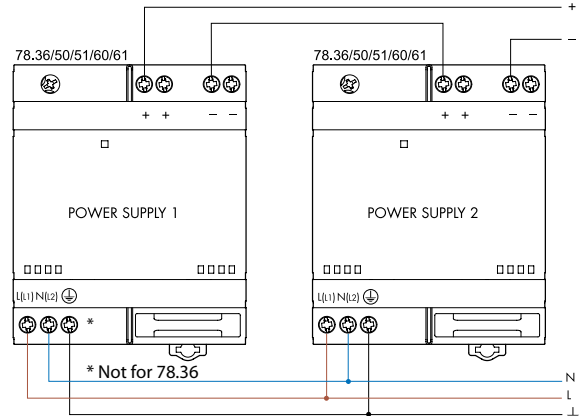

Parallel connection (78.51/61 only)

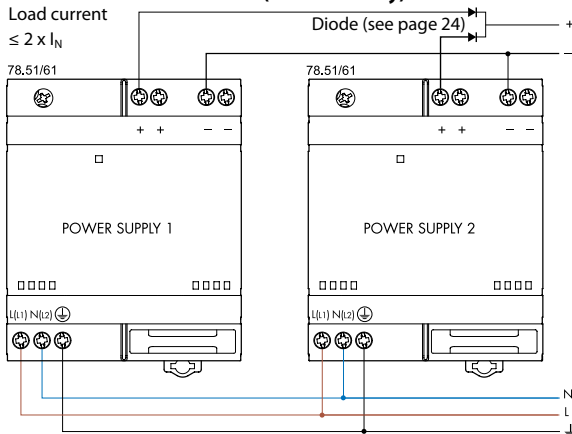

Manual redundancy

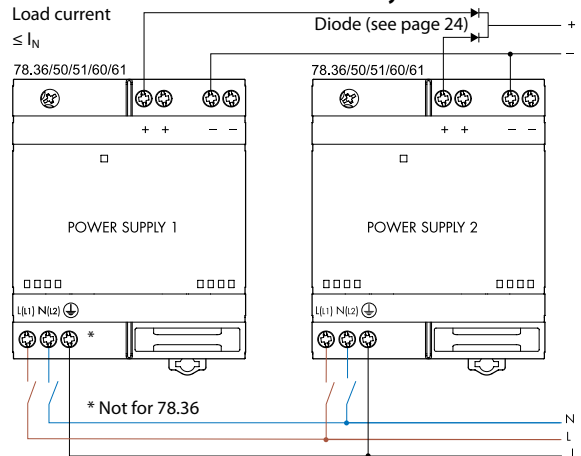

Wiring diagrams for 78.1B & 78.1D

Basic connections

78.1B - Power supply connection

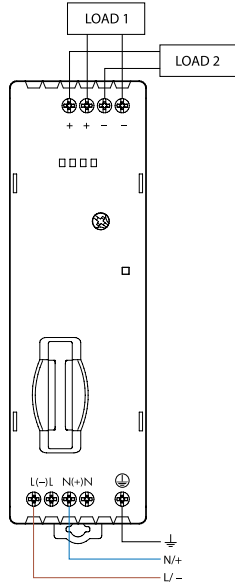

78.1D - Power supply connection

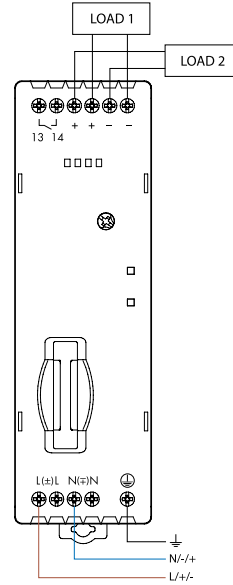

Dual polarity connection

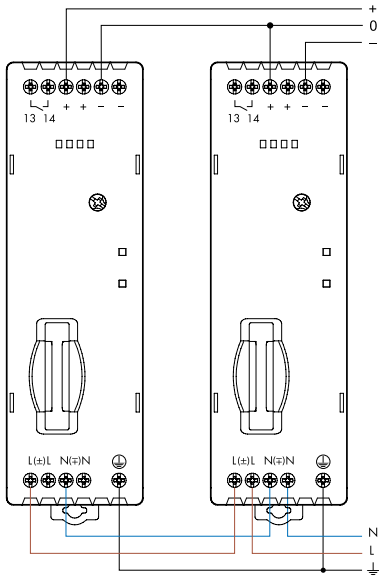

Parallel connection

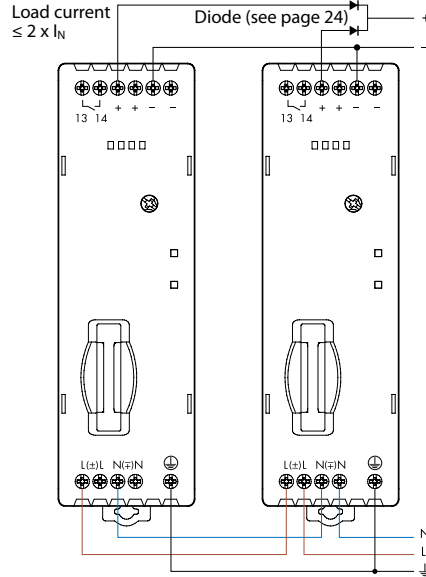

Series connection

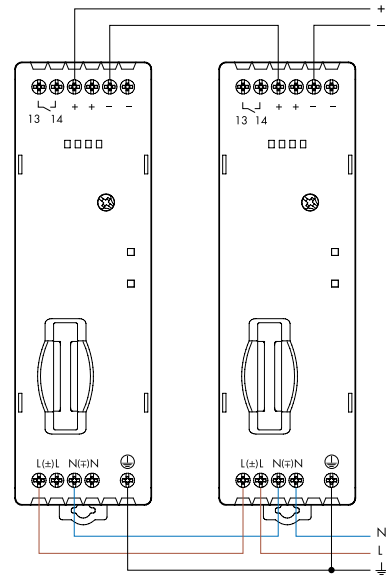

F

Wiring diagrams for 78.2E

Basic connections

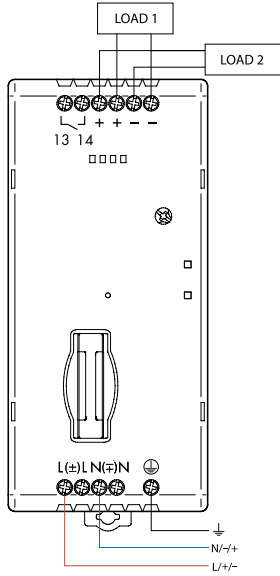

Dual polarity connection

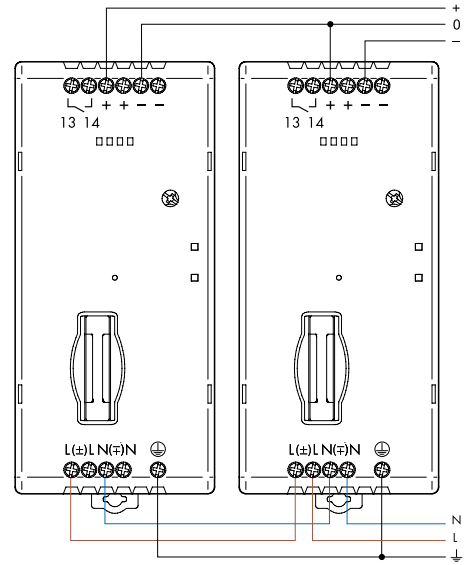

Parallel connection

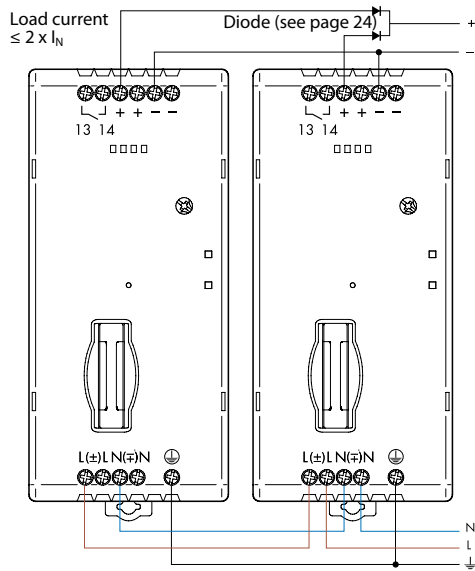

Series connection

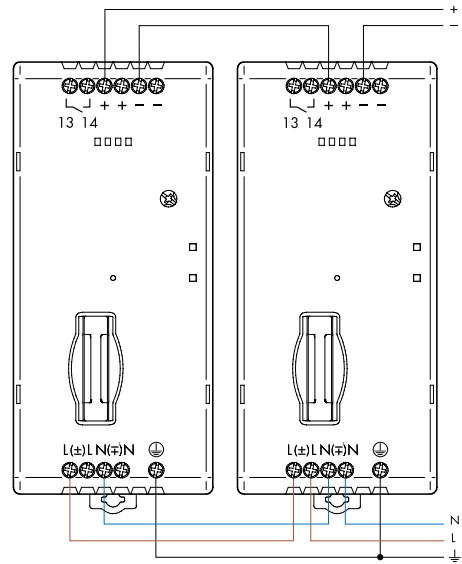

Wiring diagram for 78.1A

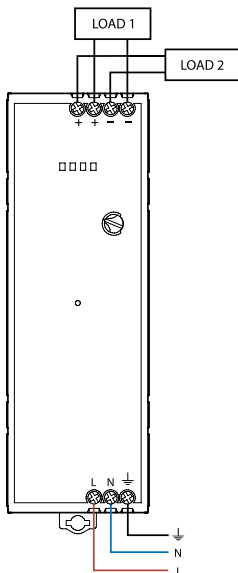

Wiring diagram for 78.2A

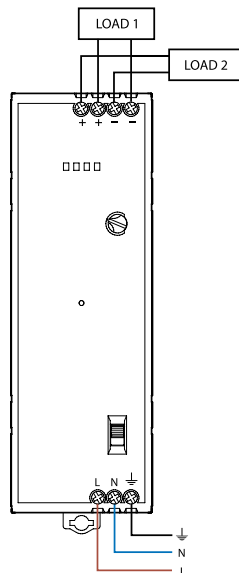

Wiring diagram for 78.2K

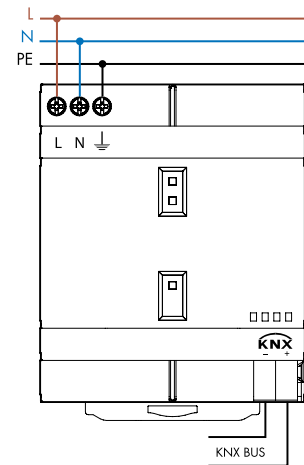

Diode(s)

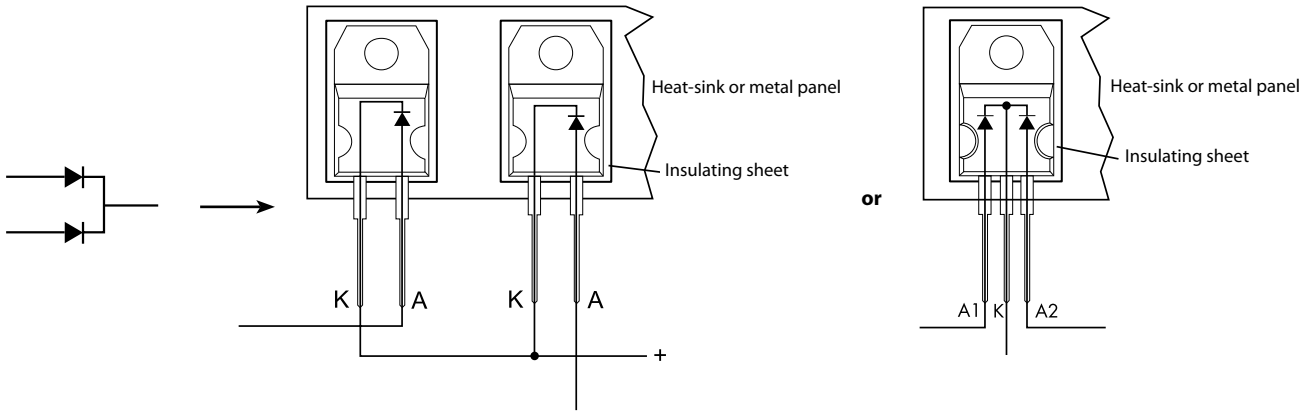

Diode for type 78.25, 78.36, 78.50, 78.60, 78.51, 78.61

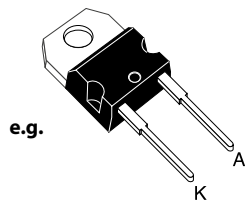

e.g.

TO-220AC
STPS1545D

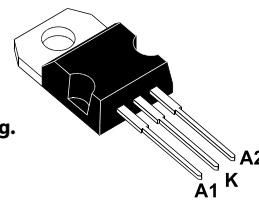

e.g.

TO-220AB
STPS30L40CT

Diode for type 78.1B, 78.1D, 78.2E

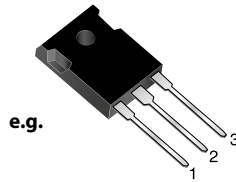

e.g.

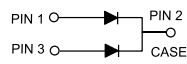

TO-247AD
MBR 4060PT

Outline drawings

Type 78.12
Screw terminal

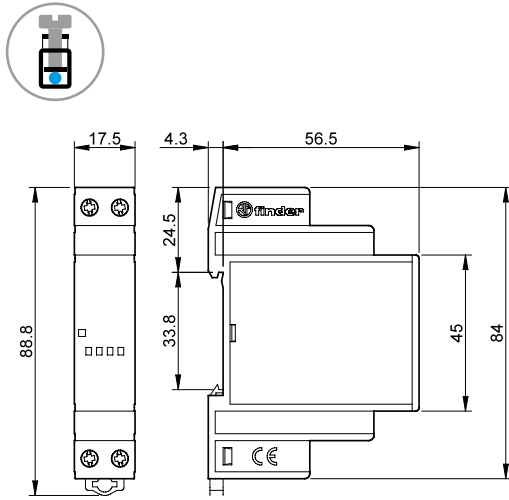

Type 78.25
Screw terminal

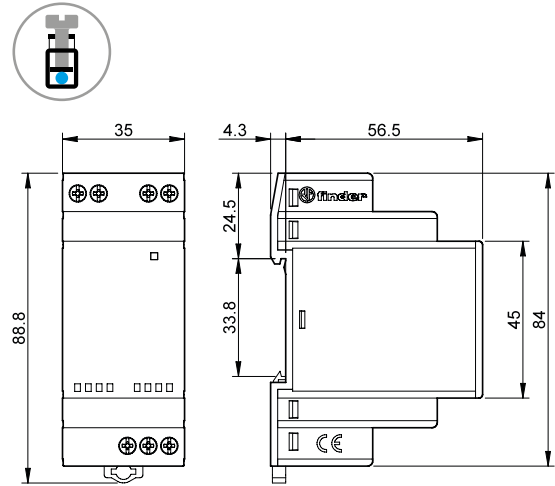

Type 78.36
Screw terminal

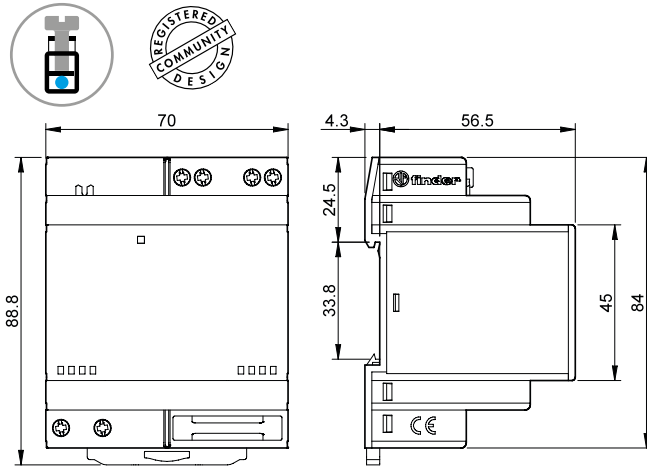

Types 78.50 / 78.60
Screw terminal

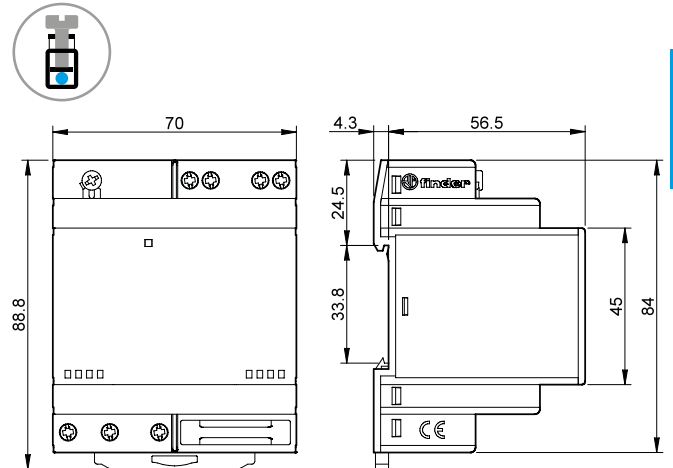

Types 78.51 / 78.61
Screw terminal

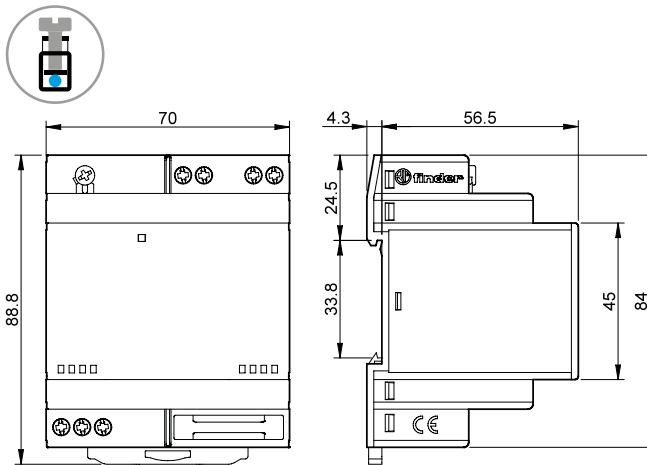

Type 78.1B
Screw terminal

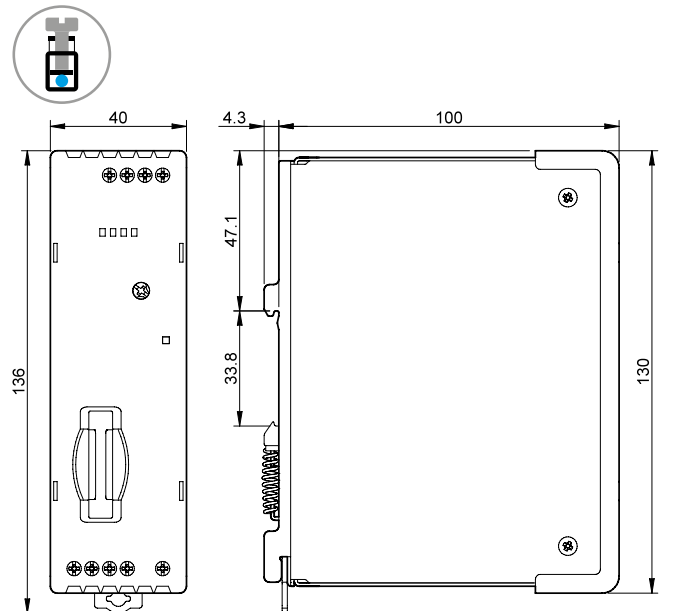

Outline drawings

Type 78.1D
Screw terminal

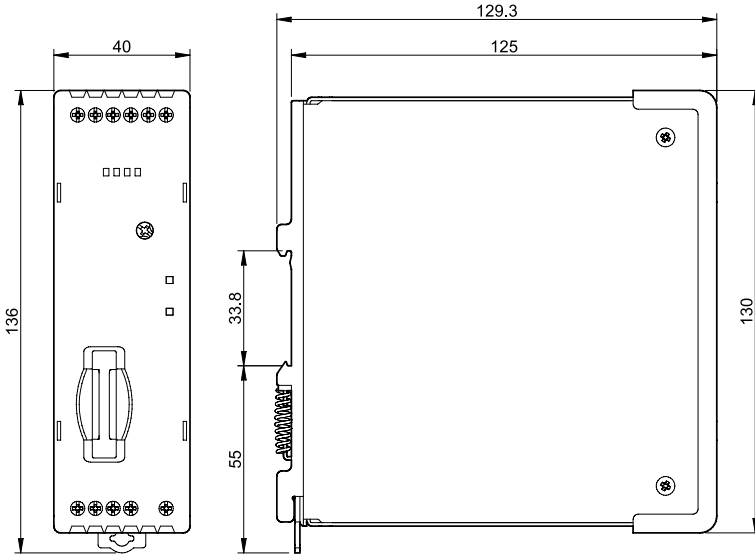

F

Type 78.2E
Screw terminal

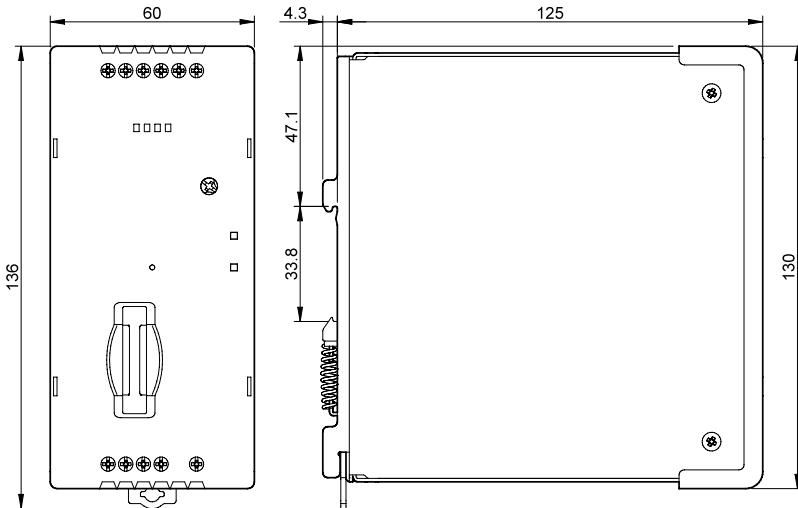

Outline drawings

Type 78.1A
Screw terminal

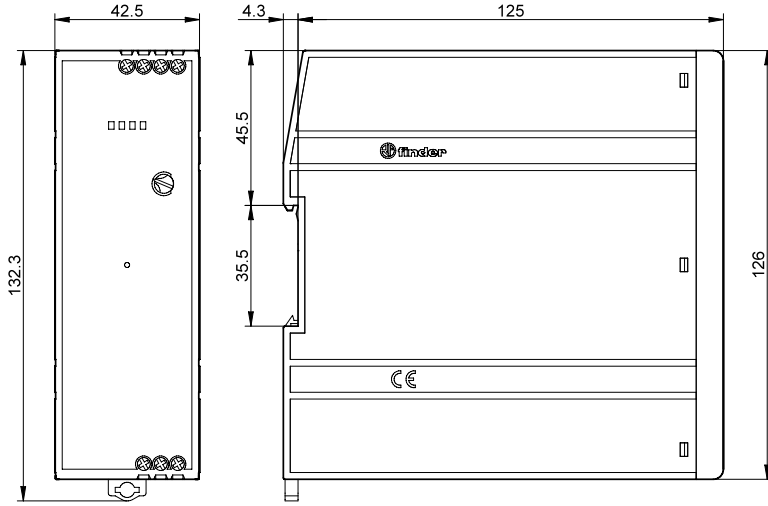

Type 78.2A
Screw terminal

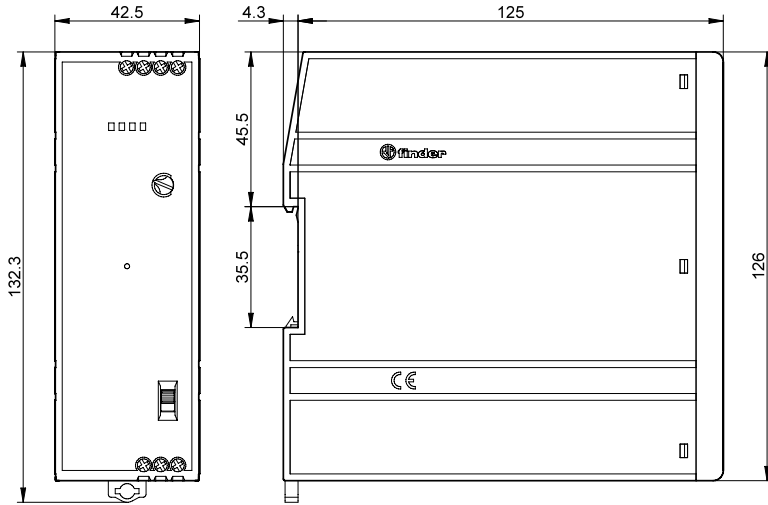

Outline drawings

Type 78.2K
Screw terminal

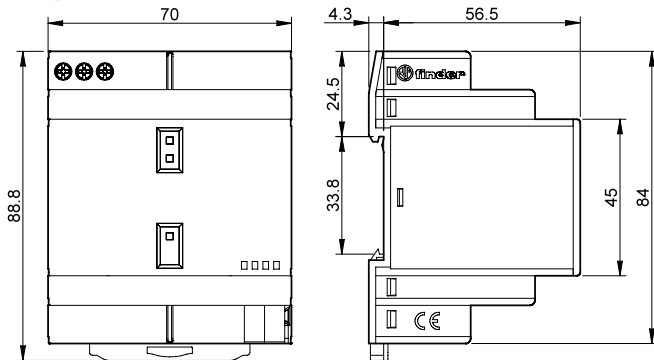

Accessories

F

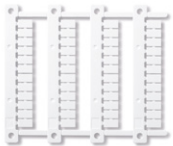

Sheet of marker tags (CEMBRE Thermal transfer printers), (48 tags), 6 x 12 mm | 060.48

060.48



Identification tag, plastic, 1 tag, 17 x 25.5 mm (for 78.12/25/36/50/60/51/61) | 019.01

019.01