

Auxiliary switch transverse 1 NO+1 NC screw terminal for circuit breaker 3RV2



General technical data:

Product brand name		SIRIUS
Product designation		auxiliary switch, transverse on the front
Design of the product		transverse auxiliary switches
Size of the circuit-breaker		S00, S0, S2, S3
Protection class IP on the front		IP20
Ambient temperature		
• during storage	°C	-50 ... +80
• during operation	°C	-20 ... +60

Auxiliary circuit:

Number of NC contacts for auxiliary contacts instantaneous contact		1
Number of NO contacts for auxiliary contacts instantaneous contact		1
Number of CO contacts of auxiliary contacts instantaneous contact		0
Operating current		
• of auxiliary contacts		
— at AC-12		

— at 24 V	A	2.5
— at 230 V	A	2.5
— maximum	A	10
— at AC-15		
— at 24 V	A	2
— at 230 V	A	0.5
— at DC-13		
— at 24 V	A	1
— at 48 V	A	0.3
— at 60 V	A	0.15

Installation/ mounting/ dimensions:

Mounting type		plug-in fixing
Width	mm	45
Height	mm	12
Depth	mm	17

Connections/ Terminals:

Type of electrical connection for auxiliary and control current circuit		screw-type terminals
Type of connectable conductor cross-sections		
<ul style="list-style-type: none"> • for auxiliary contacts <ul style="list-style-type: none"> — solid — finely stranded — with core end processing • at AWG conductors for auxiliary contacts 		2x (0.5 ... 1.5 mm ²), 2x (0.75 ... 2.5 mm ²) 2x (0.5 ... 1.5 mm ²), 2x (0.75 ... 2.5 mm ²) 2x (20 ... 14)

Certificates/ approvals:

Certificate of suitability		CE / UL / CSA / CCC
-----------------------------------	--	---------------------

General Product Approval	Declaration of Conformity
--------------------------	---------------------------



[KC](#)



Declaration of Conformity	Test Certificates	Shipping Approval
---------------------------	-------------------	-------------------

[Miscellaneous](#)

[Special Test Certificate](#)

[Type Test Certificates/Test Report](#)



Shipping Approval	other	Railway
-------------------	-------	---------



[Confirmation](#)



[Vibration and Shock](#)

Railway

[Confirmation](#)

Further information

Information- and Downloadcenter (Catalogs, Brochures,...)

<http://www.siemens.com/industrial-controls/catalogs>

Industry Mall (Online ordering system)

<http://www.siemens.com/industrymall>

Cax online generator

<http://support.automation.siemens.com/WW/CAXorder/default.aspx?lang=en&mfb=3RV2901-1E>

Service&Support (Manuals, Certificates, Characteristics, FAQs,...)

<https://support.industry.siemens.com/cs/ww/en/ps/3RV2901-1E>

Image database (product images, 2D dimension drawings, 3D models, device circuit diagrams, EPLAN macros, ...)

http://www.automation.siemens.com/bilddb/cax_de.aspx?mfb=3RV2901-1E&lang=en

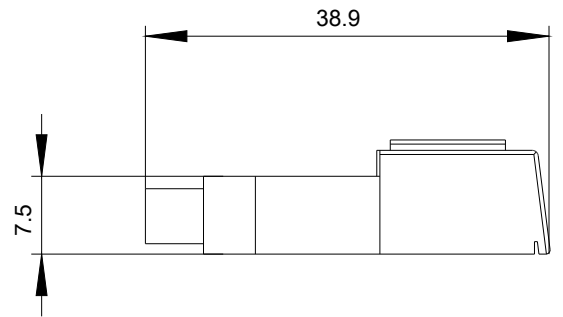
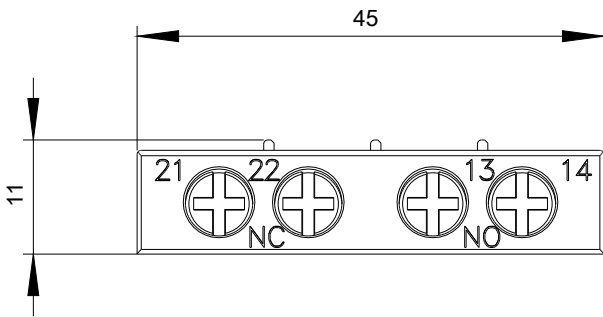

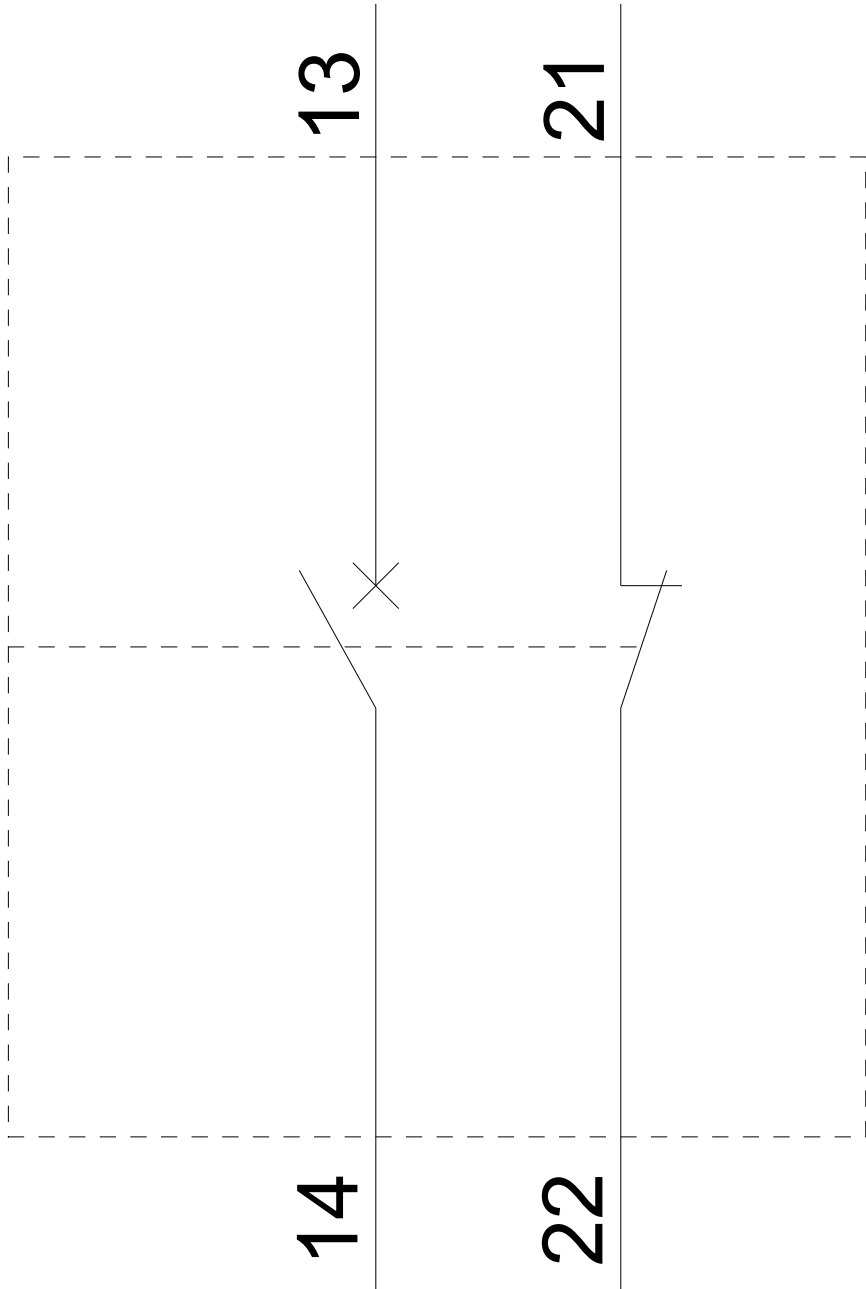

last modified:

03/21/2020